



# SD6 drive controller Manual

en-US  
01/2023  
ID 442426.12

# Table of contents

- Table of contents ..... 2**
- 1 Foreword ..... 11**
- 2 User information ..... 12**
  - 2.1 Storage and transfer ..... 12
  - 2.2 Described product ..... 12
  - 2.3 UL file number ..... 13
  - 2.4 Timeliness ..... 13
  - 2.5 Original language ..... 13
  - 2.6 Limitation of liability ..... 14
  - 2.7 Formatting conventions ..... 14
    - 2.7.1 Display of safety instructions ..... 14
    - 2.7.2 Markup of text elements ..... 15
    - 2.7.3 Mathematics and formulas ..... 15
    - 2.7.4 Conventions for cables ..... 16
  - 2.8 Marks and test symbols ..... 16
  - 2.9 Trademarks ..... 17
  - 2.10 Licenses ..... 17
- 3 General safety instructions ..... 18**
  - 3.1 Directives and standards ..... 18
  - 3.2 Qualified personnel ..... 18
  - 3.3 Intended use ..... 19
  - 3.4 Transport and storage ..... 19
  - 3.5 Operational environment and operation ..... 20
  - 3.6 Working on the machine ..... 20
  - 3.7 Ensuring traceability ..... 21
  - 3.8 Decommissioning ..... 21
  - 3.9 Disposal ..... 21
  - 3.10 Firefighting ..... 21
- 4 Security ..... 22**
- 5 UL-compliant use ..... 24**
- 6 System design ..... 26**
  - 6.1 Hardware components ..... 27
    - 6.1.1 Drive controllers ..... 27
    - 6.1.2 Operating motors, encoders and brakes ..... 31
    - 6.1.3 Accessories ..... 32

6.2	Software components .....	42
6.2.1	Project configuration and parameterization .....	42
6.2.2	Applications .....	42
<b>7</b>	<b>Technical data .....</b>	<b>43</b>
7.1	Drive controllers .....	43
7.1.1	General technical data .....	43
7.1.2	Electrical data .....	44
7.1.3	Derating .....	52
7.1.4	Dimensions .....	54
7.1.5	Weight .....	56
7.1.6	Cycle times .....	56
7.2	DC link connection .....	56
7.2.1	General technical data .....	56
7.2.2	DL6A – SD6 assignment .....	57
7.2.3	Dimensions .....	58
7.2.4	Weight .....	59
7.3	Safety technology .....	59
7.3.1	ST6 safety module .....	59
7.3.2	SE6 safety module .....	60
7.4	Operating motors .....	61
7.5	Evaluable encoders .....	62
7.5.1	Overview .....	62
7.5.2	Signal transmission .....	63
7.5.3	Drive controllers .....	64
7.5.4	Terminal module .....	67
7.5.5	Encoder adapter box .....	73
7.6	Terminal module .....	75
7.6.1	XI6 .....	75
7.6.2	RI6 .....	77
7.6.3	IO6 .....	78
7.6.4	Weight .....	79
7.7	Controllable brakes .....	79
7.7.1	X5 .....	80
7.7.2	X8 (option SE6) .....	80
7.8	Evaluable motor temperature sensors .....	80
7.9	Braking resistor .....	81
7.9.1	Tubular fixed resistor FZMU, FZZMU .....	81
7.9.2	GVADU, GBADU flat resistor .....	83
7.9.3	FGFKU steel-grid fixed resistor .....	85
7.9.4	Rear section braking resistor RB 5000 .....	86
7.10	Choke .....	88
7.10.1	TEP power choke .....	88
7.10.2	TEP output choke .....	90

7.11	Encoder adapter box .....	92
7.11.1	Dimensions .....	92
7.11.2	Weight .....	92
<b>8</b>	<b>Project configuration.....</b>	<b>93</b>
8.1	Drive controllers .....	93
8.2	DC link connection.....	93
8.2.1	Information on design and operation.....	94
8.2.2	Design .....	95
8.3	Motor.....	97
8.4	Mixed operation .....	98
8.5	Choke.....	100
8.5.1	TEP power choke .....	100
8.5.2	TEP output choke.....	101
<b>9</b>	<b>Storage.....</b>	<b>104</b>
9.1	Drive controllers .....	104
9.1.1	Annual reforming.....	104
9.1.2	Reforming before commissioning.....	105
<b>10</b>	<b>Installation.....</b>	<b>106</b>
10.1	Safety instructions for installation.....	106
10.2	Basic assembly instructions .....	106
10.2.1	Drive controllers .....	106
10.2.2	Braking resistor .....	106
10.2.3	Choke .....	107
10.3	Minimum clearances .....	108
10.4	Drilling diagrams and bore dimensions .....	110
10.4.1	Drive controllers .....	110
10.4.2	Braking resistor .....	112
10.4.3	Choke .....	113
10.5	Length of copper rails .....	115
10.6	Installing the communication module.....	116
10.7	Installing the terminal module .....	118
10.8	Installing the drive controller without a rear section module.....	121
10.9	Installing the DC link connection .....	122
10.10	Installing a rear section braking resistor .....	125
10.11	Mounting the drive controller on the rear section module .....	126
10.12	Attaching the EMC shroud.....	132
10.13	Installing the encoder adapter box.....	134

<b>11</b>	<b>Connection.....</b>	<b>135</b>
11.1	Safety instructions for connection .....	135
11.2	Line routing.....	135
11.3	Protective measures.....	136
11.3.1	Power grid supply with DC link connection .....	136
11.3.2	Line fuse.....	137
11.3.3	Grid connection for DC link connection.....	141
11.3.4	Residual current protective device.....	141
11.3.5	Protective grounding .....	142
11.3.6	EMC recommendations .....	144
11.4	Drive controllers .....	144
11.4.1	Overview with ST6 safety module .....	144
11.4.2	Overview with SE6 safety module .....	149
11.4.3	X1: Enable and relay 1 .....	155
11.4.4	X2: Motor temperature sensor.....	156
11.4.5	X3A, X3B: PC, IGB.....	157
11.4.6	X4: Encoder.....	158
11.4.7	X5: Brake – Actuation .....	160
11.4.8	X6: Brake – Feedback and supply (ST6 option).....	161
11.4.9	X7: Brake 2 – Supply (SE6 option).....	161
11.4.10	X8: Brake 2 – Safe brake control (SE6 option).....	162
11.4.11	X10: 230/400 V supply.....	163
11.4.12	X11: 24 V supply .....	164
11.4.13	X12: Safety technology (option ST6).....	165
11.4.14	X14: Safety technology – Safe inputs (SE6 option).....	166
11.4.15	X15: Safety technology – Safe outputs, supply for X50 (SE6 option) .....	167
11.4.16	X20: Motor.....	168
11.4.17	X30: DC link connection, braking resistor .....	170
11.4.18	X50: Plausibility encoder (SE6 option).....	171
11.4.19	Connecting a drive controller (ST6 option).....	172
11.4.20	Connecting a drive controller (SE6 option).....	174
11.5	Braking resistor.....	176
11.5.1	FZMU, FZZMU connection description .....	176
11.5.2	GVADU, GBADU connection description .....	177
11.5.3	FGFKU connection description .....	178
11.5.4	RB 5000 connection description .....	179
11.6	Power choke .....	179
11.6.1	Connection description.....	179
11.7	Output choke.....	180
11.7.1	Connection description.....	180
11.8	Communication module .....	181
11.8.1	EC6: EtherCAT .....	181
11.8.2	CA6: CANopen .....	183
11.8.3	PN6: PROFINET .....	184

11.9	Terminal module .....	186
11.9.1	XI6.....	186
11.9.2	RI6.....	193
11.9.3	IO6 .....	203
11.10	Encoder adapter box .....	207
11.10.1	LA6 for synchronous linear motors.....	208
11.11	Cables .....	214
11.11.1	Power cables.....	214
11.11.2	Encoder cables.....	219
<b>12</b>	<b>Operation.....</b>	<b>234</b>
12.1	Overview.....	234
12.2	Menu structure and navigation .....	235
<b>13</b>	<b>What you should know before commissioning .....</b>	<b>237</b>
13.1	DS6 program interface .....	237
13.2	Meaning of parameters.....	239
13.2.1	Parameter groups.....	239
13.2.2	Parameter types and data types.....	240
13.2.3	Parameter types .....	241
13.2.4	Parameter structure .....	241
13.2.5	Parameter visibility.....	242
13.3	Signal sources and process data mapping.....	243
13.4	Non-volatile memory.....	243
<b>14</b>	<b>Commissioning.....</b>	<b>244</b>
14.1	Initiating the project.....	244
14.1.1	Projecting the drive controller and axis.....	244
14.1.2	Configuring safety technology .....	246
14.1.3	Creating other modules and drive controllers.....	246
14.1.4	Projecting the module .....	246
14.1.5	Projecting the project .....	246
14.2	Mapping the mechanical axis model .....	247
14.2.1	Parameterizing the STOBER motor.....	247
14.2.2	Parameterizing the axis model .....	247
14.3	Transmitting and saving a configuration .....	251
14.3.1	Transmitting the configuration.....	251
14.3.2	Saving the configuration.....	253
14.4	Testing the configuration .....	253
14.4.1	Testing using DriveControlSuite .....	254
14.4.2	Testing using the operating unit.....	254

<b>15</b>	<b>Communication.....</b>	<b>257</b>
15.1	Direct connection .....	258
15.2	Remote maintenance .....	258
15.3	IGB motion bus .....	258
15.4	Fieldbus .....	258
<b>16</b>	<b>Optimizing the control cascade .....</b>	<b>259</b>
16.1	Structure of the control cascade .....	259
16.2	General procedure .....	260
16.3	Example project .....	261
16.3.1	Scope settings .....	261
16.3.2	Jog settings .....	262
16.4	Schematic sequence .....	263
16.5	Current controller – Notes .....	263
16.6	1: Velocity controller – Actual velocity filters.....	264
16.7	2: Velocity controller – Proportional coefficient .....	266
16.8	3: Velocity controller – Integral coefficient .....	270
16.9	Velocity controller – Summary .....	271
16.10	4: Position controller – Proportional coefficient .....	272
16.11	5: Position controller – Velocity controller feedforward control .....	273
16.12	Position controller – Summary .....	274
16.13	Special cases .....	274
16.13.1	Current controller – Motor reaches saturation .....	274
16.13.2	Velocity controller – High set torque.....	275
16.13.3	Position controller – Friction or play .....	275
16.13.4	Position controller – Poor resolution.....	275
<b>17</b>	<b>Brake .....</b>	<b>276</b>
17.1	Activating and selecting the brake .....	277
17.2	Activating functional brake management .....	277
17.3	Calibrate brake .....	278
17.4	Testing a functional brake .....	279
17.5	Bedding in the brake .....	280
17.6	Bedding in brake 2.....	281
17.7	More about the brake? .....	282
17.7.1	Brakes used.....	282
17.7.2	Direct and indirect brake connection .....	285
17.7.3	Internal and external brake control.....	285
17.7.4	Brake control based on control mode .....	286
17.7.5	Brake release time and brake engaging time .....	290

17.7.6	Time between 2 release processes.....	291
17.7.7	Calibrating the brake .....	292
17.7.8	Functional brake management.....	293
17.7.9	Brake test.....	295
17.7.10	Torque calculation .....	296
17.7.11	Bedding in the brake.....	298
17.7.12	Special case of load changes when the power unit is switched off.....	299
<b>18</b>	<b>Predictive Maintenance .....</b>	<b>300</b>
18.1	Legal disclaimer .....	300
18.2	Displaying the state .....	301
18.3	Sending the load matrix.....	302
18.4	Exporting the load matrix.....	303
18.5	Configuring Predictive Maintenance .....	304
18.6	Information on activation, operation and replacement.....	307
18.7	More about Predictive Maintenance?.....	307
18.7.1	Load matrix.....	307
18.7.2	Life performance indicator .....	312
18.7.3	Recommendation for geared motor replacement .....	312
18.7.4	Reading out and transmitting the load matrix .....	313
<b>19</b>	<b>Diagnostics.....</b>	<b>315</b>
19.1	Drive controllers .....	315
19.1.1	Drive controller state: LEDs .....	316
19.1.2	Drive controller state: Display .....	317
19.1.3	Service network connection .....	320
19.1.4	Fieldbus state.....	321
19.1.5	IGB state .....	324
19.1.6	Fieldbus network connection .....	325
19.1.7	Events .....	327
19.2	SE6 safety module .....	379
19.2.1	Parameters .....	379
19.2.2	Error codes.....	381
19.3	Acknowledging faults .....	386
<b>20</b>	<b>Analysis.....</b>	<b>387</b>
20.1	Scope and multi-axis scope .....	388
20.1.1	Scope settings.....	391
20.1.2	Image editor .....	396
20.1.3	Frequency analysis.....	399
20.2	Scope image .....	400
20.2.1	Creating a scope image.....	400
20.2.2	Combining scope images .....	403
20.2.3	Creating a direct image.....	403



20.3	Multi-axis scope images .....	407
20.3.1	Prerequisites .....	407
20.3.2	Creating a multi-axis scope image .....	408
20.4	Parameters .....	411
20.4.1	T25   Automatic start   G6   V0 .....	411
20.4.2	T26   Retrigger scope   G6   V1 .....	412
<b>21</b>	<b>Replacement .....</b>	<b>413</b>
21.1	Safety instructions for device replacement .....	413
21.2	Notes on the safety configuration .....	413
21.3	Notes on motor replacement .....	414
21.4	Replacing the drive controller .....	414
21.5	Replacing the Paramodul .....	416
21.6	Replacing or updating firmware using DS6 .....	417
<b>22</b>	<b>Service .....</b>	<b>418</b>
22.1	Information about the product .....	418
22.2	STOBER electronics service .....	418
22.3	Reverse documentation .....	419
22.3.1	Drive controller without SE6 option .....	419
22.3.2	Drive controller with SE6 option .....	421
<b>23</b>	<b>Appendix .....</b>	<b>424</b>
23.1	Weights .....	424
23.2	Terminal specifications .....	426
23.2.1	Overview .....	426
23.2.2	BCF 3,81 180 SN .....	428
23.2.3	BFL 5.08HC 180 SN .....	428
23.2.4	BLDF 5.08 180 SN .....	429
23.2.5	DFMC 1.5 -ST-3.5 .....	429
23.2.6	FK-MCP 1,5 -ST-3,5 .....	430
23.2.7	FMC 1,5 -ST-3,5 .....	431
23.2.8	G 10/2 .....	431
23.2.9	GFKC 2,5 -ST-7,62 .....	432
23.2.10	GFKIC 2.5 -ST-7.62 .....	432
23.2.11	ISPC 5 -STGCL-7,62 .....	433
23.2.12	ISPC 16 -ST-10,16 .....	433
23.2.13	MKDSP 25 -15,00 .....	434
23.2.14	SPC 5 -ST-7,62 .....	434
23.2.15	SPC 16 -ST-10,16 .....	435
23.3	Wiring examples .....	436
23.3.1	Stand-alone operation with direct brake control .....	436
23.3.2	Stand-alone operation with indirect brake control .....	437
23.3.3	DC link connection .....	438

---

23.4	Device addressing.....	439
23.5	DriveControlSuite .....	440
23.5.1	System requirements.....	440
23.5.2	Installation types .....	440
23.5.3	Installing DriveControlSuite .....	441
23.5.4	Updates .....	441
23.5.5	Communication requirements.....	442
23.5.6	Configuring virtual machines .....	444
23.5.7	Script mode.....	445
23.5.8	Information for SSI encoders .....	470
23.6	Detailed information .....	476
23.7	Symbols in formulas .....	478
23.8	Abbreviations .....	480
<b>24</b>	<b>Contact .....</b>	<b>482</b>
24.1	Consultation, service and address.....	482
24.2	Your opinion is important to us.....	482
24.3	Close to customers around the world .....	483
	<b>Glossary .....</b>	<b>484</b>
	<b>List of figures.....</b>	<b>492</b>
	<b>List of tables.....</b>	<b>495</b>

# 1 Foreword

STOBER drive controllers of the SD6 series offer maximum precision and productivity for automation technology and mechanical engineering despite ever more complex functions. Highly dynamic drives ensure the shortest recovery times from fast changes in set value and load jumps. There is also an option of connecting the drive controllers in a DC link for multi-axis applications, which improves the energy footprint of the entire system. The SD6 drive controller is available in four sizes with a nominal output current of up to 85 A.

## Features

- Control of linear and rotary synchronous servo motors and asynchronous motors
- Multi-functional encoder interfaces
- Automatic motor parameterization from the electronic motor nameplate
- Isochronic system bus (IGB motion bus) for parameterization and multi-axis applications
- Communication over CANopen, EtherCAT or PROFINET
- Safe Torque Off (STO) in the standard version, expanded safety technology (SS1, SS2, SLS, etc.) as an option
- Digital and analog inputs and outputs as an option
- Brake chopper, brake control and line filter
- Energy supply through direct power supply
- Flexible DC link connection for multi-axis applications
- Convenient operating unit consisting of graphical display and keys
- Paramodul removable data storage for quick commissioning and service

## 2 User information

This documentation covers the SD6 drive controller. You will receive support for the assembly of the individual modules along with the associated components that you will need to operate the drive controllers in the control cabinet.

You will also find information on wiring the modules correctly and checking their functionality in the group with an initial test.

Combinations with other 6th generation STOBER drive controllers are possible under certain boundary conditions.

More detailed information on project configuration, diagnostics and service are additional topics covered in this manual.

### 2.1 Storage and transfer

As this documentation contains important information for handling the product safely and efficiently, it must be stored in the immediate vicinity of the product until product disposal and be accessible to qualified personnel at all times.

Also pass on this documentation if the product is transferred or sold to a third party.

### 2.2 Described product

This documentation is binding for:

SD6 series drive controllers in conjunction with the DriveControlSuite software (DS6) in V 6.5-H or higher, PASmotion in V 1.3.0 or higher and associated firmware in V 6.5-H or higher.

## 2.3 UL file number

cULus certified devices with the corresponding test symbol meet the requirements of standards UL 508C and UL 840.

Under the file number specified in the following table, you can find the product in the online database of Underwriter Laboratories (UL):

<https://iq2.ulprospector.com>

Type		File number	UL Category Control Number		Certification
			America	Canada	cULus/cURus
Drive controller	SD6A02	E189114	NMMS	NMMS7	cULus
	SD6A04				
	SD6A06				
	SD6A14				
	SD6A16				
	SD6A24				
	SD6A26				
	SD6A34				
	SD6A36				
	SD6A38				
Braking resistors	FZMU, FZZMU	E212934	NMTR2	NMTR8	cURus
	GVADU, GBADU				
	FGFKU				
	RB 5000				
Power chokes	TEP4010-2US00	E103902	XQNX2	XQNX8	cURus
Output chokes	TEP3720-0ES41	E333628	NMMS2	NMMS8	cURus
	TEP3820-0CS41				
	TEP4020-0RS41				
Motors	Synchronous servo motors of the EZ series	E488992	PRHZ2	PRHZ8	cURus
	Asynchronous motors	E216143	PRGY2	PRGY8	cURus
Encoder and power cables	All types	E172204	AVLV2	AVLV8	cURus

Tab. 1: File number-certified products

## 2.4 Timeliness

Check whether this document is the latest version of the documentation. We make the latest document versions for our products available for download on our website:

<http://www.stoeber.de/en/downloads/>.

## 2.5 Original language

The original language of this documentation is German; all other language versions are derived from the original language.

## 2.6 Limitation of liability

This documentation was created taking into account the applicable standards and regulations as well as the current state of technology.

No warranty or liability claims for damage shall result from failure to comply with the documentation or from use that deviates from the intended use of the product. This is especially true for damage caused by individual technical modifications to the product or the project configuration and operation of the product by unqualified personnel.

## 2.7 Formatting conventions

Orientation guides in the form of signal words, symbols and special text markups are used to emphasize specific information so that you are able identify it in this documentation quickly.

### 2.7.1 Display of safety instructions

Safety instructions are identified with the following symbols. They indicate special risks when handling the product and are accompanied by relevant signal words that express the extent of the risk. Furthermore, useful tips and recommendations for efficient, error-free operation are specially highlighted.

---

**ATTENTION!**

**Attention**

This indicates that damage to property may occur

- if the stated precautionary measures are not taken.

---



---

 **CAUTION!**

**Caution**

This word with a warning triangle indicates that minor personal injury may occur

- if the stated precautionary measures are not taken.

---



---

 **WARNING!**

**Warning**

This word with a warning triangle means there may be a considerable risk of fatal injury

- if the stated precautionary measures are not taken.

---



---

 **DANGER!**

**Danger**

This word with a warning triangle indicates that there is a considerable risk of fatal injury

- if the stated precautionary measures are not taken.

---



---

**Information**

**Information**

Information indicates important information about the product or serves to emphasize a section in the documentation that deserves special attention from the reader.

---

## 2.7.2 Markup of text elements

Certain elements of the continuous text are distinguished as follows.

<b>Important information</b>	Words or expressions with a special meaning
Interpolated position mode	Optional: File or product name or other name
<u>Detailed information</u>	Internal cross-reference
<a href="http://www.samplelink.com">http://www.samplelink.com</a>	External cross-reference

### Software and other displays

The following formatting is used to identify the various information content of elements referenced by the software interface or a drive controller display, as well as any user entries.

Main menu Settings	Window names, dialog box names, page names or buttons, combined proper nouns, functions referenced by the interface
Select Referencing method A	Predefined entry
Save your <own IP address>	User-defined entry
EVENT 52: COMMUNICATION	Displays (status, messages, warnings, faults)

Keyboard shortcuts and command sequences or paths are represented as follows.

[Ctrl], [Ctrl] + [S]	Key, shortcut
Table > Insert table	Navigation to menus/submenus (path specification)

### Buttons

The buttons of the drive controller are depicted as follows in .

[OK]	
------	---

## 2.7.3 Mathematics and formulas

The following signs are used to represent mathematical relationships and formulas.

–	Subtraction
+	Addition
×	Multiplication
÷	Division
	Absolute value

## 2.7.4 Conventions for cables

In the cable connection descriptions, core colors are shortened and used as follows.

### Cable colors

BK:	BLACK	PK:	PINK
BN:	BROWN	RD:	RED
BU:	BLUE	VT:	VIOLET
GN:	GREEN	WH:	WHITE
GY:	GRAY	YE:	YELLOW
OG:	ORANGE		

### Formatting conventions

Two-colored core:	WHYE	WHITEYELLOW (white and yellow)
Single-colored core:	BK/BN	BLACK/BROWN (black or brown)

## 2.8 Marks and test symbols

The following marks and test symbols are mentioned in the technical data.



### RoHS lead-free mark

Marking in accordance with RoHS directive 2011-65-EU.



### CE mark

Manufacturer's self declaration: The product meets the requirements of EU directives.



### UKCA test symbol

Manufacturer's self declaration: The product meets the requirements of UK directives.



### UL test symbol (cULus)

This product is listed by UL for the United States and Canada.

Representative samples of this product have been evaluated by UL and meet the requirements of applicable standards.



### UL test symbol for recognized component mark (cURus)

This component or material is recognized by UL. Representative samples of this product have been evaluated by UL and meet applicable requirements.



## 2.9 Trademarks

The following names used in connection with the device, its optional equipment and its accessories are trademarks or registered trademarks of other companies:

CANopen <sup>®</sup> , CiA <sup>®</sup>	CANopen <sup>®</sup> and CiA <sup>®</sup> are registered European Union trademarks of CAN in AUTOMATION e.V., Nuremberg, Germany.
EnDat <sup>®</sup>	EnDat <sup>®</sup> and the EnDat <sup>®</sup> logo are registered trademarks of Dr. Johannes Heidenhain GmbH, Traunreut, Germany.
EtherCAT <sup>®</sup> , Safety over EtherCAT <sup>®</sup> , TwinCAT <sup>®</sup>	EtherCAT <sup>®</sup> , Safety over EtherCAT <sup>®</sup> and TwinCAT <sup>®</sup> are registered trademarks of patented technologies licensed by Beckhoff Automation GmbH, Verl, Germany.
Hyper-V <sup>®</sup>	Hyper-V <sup>®</sup> is a registered trademark of the Microsoft Corporation in the United States and/or other countries.
PLCopen <sup>®</sup>	PLCopen <sup>®</sup> is a registered trademark of the PLCopen Organisation, Gorinchem, Netherlands.
PROFIBUS <sup>®</sup> , PROFINET <sup>®</sup>	PROFIBUS <sup>®</sup> and PROFINET <sup>®</sup> are registered trademarks of PROFIBUS Nutzerorganisation e.V., Karlsruhe, Germany.
speedtec <sup>®</sup>	speedtec <sup>®</sup> is a registered trademark of TE Connectivity Industrial GmbH, Niederwinkling, Germany.
VirtualBox <sup>®</sup>	VirtualBox <sup>®</sup> is a registered trademark of Oracle America, Inc., Redwood Shores, USA.
VMware <sup>®</sup>	VMware <sup>®</sup> is a registered trademark of VMware, Inc., Palo Alto, USA.
Windows <sup>®</sup> , Windows <sup>®</sup> 7, Windows <sup>®</sup> 10	Windows <sup>®</sup> , das Windows <sup>®</sup> -Logo, Windows <sup>®</sup> XP, Windows <sup>®</sup> 7 und Windows <sup>®</sup> 10 are registered trademarks of Microsoft Corporation in the United States and/or other countries.

All other trademarks not listed here are the property of their respective owners.

Products that are registered as trademarks are not specially indicated in this documentation. Existing property rights (patents, trademarks, protection of utility models) are to be observed.

## 2.10 Licenses

Software from the following licensor is used in the SD6 drive controller:

SEGGER Microcontroller GmbH & Co. KG  
 In den Weiden 11  
 40721 Hilden  
 Germany  
 Phone+49 2103-2878-0  
 Fax+49 2103-2878-28  
 Email: [info@segger.com](mailto:info@segger.com)  
 Internet: <http://www.segger.com>

## 3 General safety instructions

There are risks associated with the product described in this documentation that can be prevented by complying with the described warning and safety instructions as well as the included technical rules and regulations.

### 3.1 Directives and standards

The following European directives and standards are relevant to the drive controllers:

- Machinery Directive 2006/42/EC
- Low Voltage Directive 2014/35/EU
- EMC Directive 2014/30/EU
- EN ISO 13849-1:2015
- EN ISO 13849-2:2012
- EN 61800-3:2004 and A1:2012
- EN 61800-5-1:2007
- EN 61800-5-2:2007

Subsequent references to the standards do not specify the respective year in order to improve readability.

### 3.2 Qualified personnel

In order to be able to perform the tasks described in this documentation, the persons instructed to perform them must have the appropriate professional qualification and be able to assess the risks and residual hazards when handling the products. For this reason, all work on the products as well as their operation and disposal may be performed only by professionally qualified personnel.

Qualified personnel are persons who have acquired the authorization to perform these activities either through training to become a specialist and/or instruction by specialists.

Furthermore, valid regulations, legal requirements, applicable basic rules, this documentation and the safety instructions included in it must be carefully read, understood and observed.

## 3.3 Intended use

As defined by EN 50178, SD6 drive controllers are electrical devices operating as power electronics to control the flow of energy in high-voltage systems.

They are intended solely for the operation of motors that meet the requirements of EN 60034-1:

- Synchronous servo motors (e.g. of the EZ series)
- Asynchronous motors
- Linear motors
- Torque motors

The connection of other electronic loads or operation outside applicable technical specifications constitutes improper use.

When installing drive controllers in machines, commissioning (i.e. commencing intended operation) may not be performed until it has been determined that the machine is in compliance with local laws and directives. For example, in the European region, the following applies:

- Machinery Directive 2006/42/EC
- Low Voltage Directive 2014/35/EU
- EMC Directive 2014/30/EU

### EMC-compliant installation

The SD6 drive controller and accessories must be installed and wired compliant for EMC

### Modification

As the user, you may not make any physical, technical or electrical modifications to the SD6 drive controller and the accessories.

### Maintenance

The SD6 drive controller and accessories are maintenance-free. However, take appropriate measures to detect or prevent possible errors in the connecting wiring.

## 3.4 Transport and storage

Inspect the delivery for any transport damage immediately after you receive it. Notify the transport company of any damage immediately. Do not put a damaged product into operation.

To ensure the faultless and safe operation of the products, they must be professionally configured, installed, operated and maintained.

Store the products in a dry and dust-free room if you do not install them immediately.

Transport and store the products in the original packaging and protect the products from mechanical impacts and vibrations. Observe the transport and storage conditions recommended in the technical data.

Reform drive controllers in storage annually or before commissioning (see [Storage \[▶ 104\]](#)).

### 3.5 Operational environment and operation

The products are subject to sales restrictions in accordance with EN IEC 61800-3.

The products are not designed for use in a public low-voltage network that supplies residential areas. Radio-frequency interference can be expected if the products are used in this type of network.

The products are intended exclusively for installation in control cabinets with at least protection class IP54.

Always operate the products within the limits specified by the technical data.

The following applications are prohibited:

- Use in potentially explosive atmospheres
- Use in environments with harmful substances as specified by EN 60721, such as oils, acids, gases, vapors, dust and radiation

Implementation of the following applications is permitted only after approval from STOBER:

- Use in non-stationary applications
- The use of active components (drive controllers, supply modules, regenerative feedback modules or discharge units) from third-party manufacturers

The drive controller is designed exclusively for operation in TN networks or on wye sources. At a nominal voltage of 200 to 480 V<sub>AC</sub>, they are permitted to supply a maximum differential short-circuit current in accordance with the following table:

Size	Max. differential short-circuit current
Size 0 – size 2	5000 A
Size 3	10000 A

Tab. 2: Maximum differential short-circuit current

The drive controller has a configurable restart. If the drive controller is designed for an automatic restart after energy shutdown, this must be clearly specified on the system in accordance with EN 61800-5-1.

The drive controller has the option of a Safe Torque Off safety function (STO) in accordance with EN 61800-5-2 for safely disconnecting the energy supply to the motor. Measures based on this for protection against unexpected startup are described in EN ISO 12100 and EN ISO 14118, for example.

### 3.6 Working on the machine

Before all work on machines and systems, apply the 5 safety rules in accordance with DIN VDE 0105-100 (Operation of electrical installations – Part 100: General requirements) in the order listed:

- Disconnect (also ensure that the auxiliary circuits are disconnected).
- Ensure power cannot be switched on again.
- Ensure that everything is de-energized.
- Ground and short circuit.
- Cover adjacent live parts.

<b>Information</b>
--------------------

Note the discharge time of the DC link capacitors in the general technical data for the devices. You can only determine the absence of voltage after this time period.

## 3.7 Ensuring traceability

The orderer must ensure traceability of the products using the serial number.

## 3.8 Decommissioning

In safety-oriented applications, note the mission time  $T_M = 20$  years in the safety-relevant key performance indicators. A drive controller with integrated safety module must be taken out of operation 20 years after the production date. The production date of the drive controller is found on the accompanying nameplate.

For detailed information about using the safety technology, refer to the corresponding manual (see [Detailed information \[► 476\]](#)).

## 3.9 Disposal

Observe the current national and regional regulations when disposing of the packaging and product! Dispose of the packaging and individual product parts depending on their properties, e.g. as:

- Cardboard
- Electronic waste (circuit boards)
- Plastic
- Sheet metal
- Copper
- Aluminum
- Battery

## 3.10 Firefighting



### **Electrical voltage! Risk of fatal injury due to electric shock!**

There is a risk of fatal injury due to electric shock when using conductive firefighting equipment.

- Use ABC powder or carbon dioxide (CO<sub>2</sub>) for firefighting.

## 4 Security

Security refers to the protection and safety of your components and systems with regard to confidentiality, integrity and availability.

While functional safety technology focuses on the avoidance of systematic or random faults, security technology is based on targeted influences. These influences may be intentional or unintentional with direct or indirect access to equipment.

### Security risks

- Incorrect operation, e.g. connection to an incorrect device
- Hardware:
  - Changing the wiring
  - Changing the device configuration, e.g. the DIP switch
  - Disassembly of accessories, e.g. from the Paramodul
- Software:
  - Changing the firmware
  - Changing the device configuration, e.g. via DriveControlSuite, via the Paramodul or using Script mode
  - Changing parameters
- Network structure

### Recognizing and avoiding risks

For example, the following tools are available to help you identify risks and avoid tampering.

- Make sure that the device identification is unique:
  - Reference code
  - Communication address(es)
- After establishing the connection, make sure that communication with the desired device has been established.
- Test and log the (re)commissioning.
- Limit access:
  - Physically (close off the control cabinet and electrical operating room)
  - Logically (restrict communication, e.g. by means of a firewall)
- Use sealing tape to detect tampering at the following interfaces:
  - PC, IGB X3A and X3B interfaces
  - Fieldbus interfaces X200 and X201
  - Paramodul with microSD card
- Make sure that the controller runs a plausibility check:
  - Device status
  - Application-specific configuration ID

### Planning measures

The requirements from the locally applicable safety and application standards regarding protection against tampering must be observed. The authorization of personnel and the implementation of the necessary protective measures are the responsibility of the operator.

All systems to be protected must be considered individually. Organizational protective measures are supported by technical measures. Technical measures alone are not sufficient.

In the course of planning, you should name and document the measures to be taken.

Such measures include:

- Sensible division of user groups
- Use of appropriate passwords
- Updated network plans

Network plans can be used to ensure that secure networks are permanently separated from public networks and, if necessary, that there is only defined access (e.g. via a firewall or a DMZ).

A regular, e.g. annual, review of the security measures is advisable.

### Defense in depth concept

Counter risks with layered security solutions.

In accordance with EN IEC 62443-4-1, the defense-in-depth concept is an approach to defend the system against any kind of attack by applying multiple independent methods.

Features:

- The approach is based on the fundamental idea that any protective measure can be, and probably will be, overcome.
- Attackers have to overcome or bypass each layer without being detected.
- A weakness in one layer can be mitigated by the capabilities of another layer.
- The system's IT security becomes a set of layers within the overall IT network security.
- Each layer should stand alone, should not be based on the same functionality as the other layers and should not have the same failure modes as them.

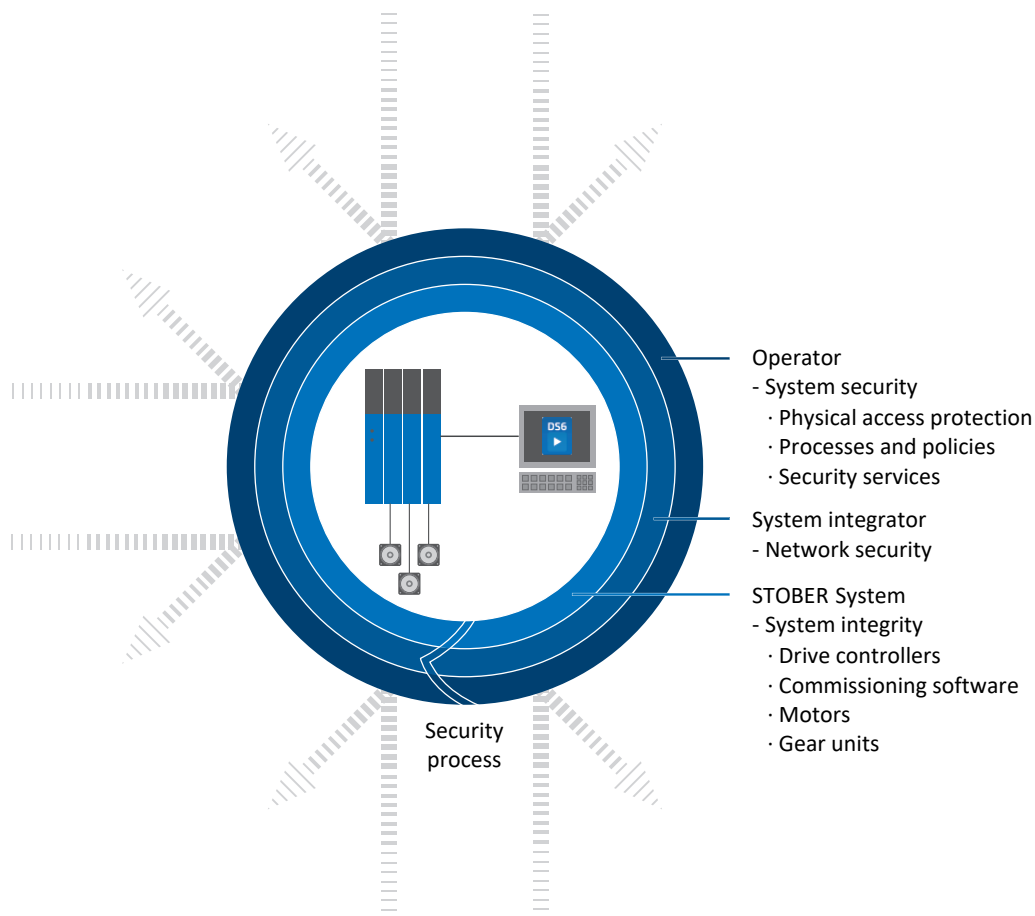

Fig. 1: Defense in depth concept

## 5 UL-compliant use

This chapter contains relevant information for use under UL conditions (UL – Underwriters Laboratories).

### Surrounding air temperature and pollution degree

The maximum surrounding air temperature for UL-compliant operation is 45 °C. Use in an environment with pollution degree 2 is permitted.

### Network layout

All device types supplied with 480 V<sub>AC</sub> are intended solely for operation with grounded wye sources at 480/277 V<sub>AC</sub>.

The drive controller is designed exclusively for operation in TN networks or on wye sources. At a nominal voltage of 240 to 480 V<sub>AC</sub>, they are permitted to supply a maximum differential short-circuit current in accordance with the following table:

Size	Max. differential short-circuit current
Size 0 – size 2	5000 A
Size 3	10000 A

Tab. 3: Maximum differential short-circuit current

### Power supply and motor overload protection

Obey the specification of  $I_{2\text{maxPU}}$  at 8 kHz clock frequency in the [electrical data of the drive controller](#) [► 44].

### Line fuse

Obey the information on the [UL-compliant line fuse of the supplied drive controllers](#) [► 140].

### Overvoltage protection

In accordance with CSA-C22.2 No. 14-13, the following applies for use in Canada:

Depending on the device type, additional overvoltage protection must be installed in the network upstream of the device and must fulfill the following conditions.

- 1-phase drive controller:
  - Overvoltage category 3
  - Phase-ground = 240 V<sub>AC</sub> (peak permitted rated surge voltage = 4 kV)
  - Phase-phase (or N) = 240 V<sub>AC</sub> (peak permitted rated surge voltage = 4 kV)
- 3-phase drive controller:
  - Overvoltage category 3
  - Phase-ground = 277 V<sub>AC</sub> (peak permitted rated surge voltage = 4 kV)
  - Phase-phase (or N) = 480 V<sub>AC</sub> (peak permitted rated surge voltage = 6 kV)

### Motor protection

The drive controller has a certified i<sup>2</sup>t model, a computational model for thermal monitoring of the motor. This fulfills the requirements for solid state motor overload protection in accordance with the amendment to UL 508C from May 2013. In order to activate it and start the protective function, set the parameters as follows (deviating from the default values): U10 = 2:Warning and U11 = 1.00 s. This model can be used instead of or in addition to temperature-monitored motor protection.



### Motor temperature sensor

The drive controller features connections for PTC thermistors (NAT 145 °C), KTY temperature sensors (KTY84-130) or Pt temperature sensors (Pt1000). For a proper connection, obey the terminal description [X2: Motor temperature sensor](#) [[▶ 156](#)].

#### Information

STOBER recommends the use of PTC thermistors as thermal winding protection.

### Power terminals

Sizes 0 to 2: Use only copper conductors for a surrounding temperature of 60/75 °C.

Size 3: Use only copper conductors for a surrounding temperature of 75 °C.

### 24 V supply and fuses

Low-voltage circuits must be supplied by an isolated source with a maximum output voltage that does not exceed 30 V<sub>DC</sub>.

Fuses for 24 V<sub>DC</sub> supplies must be approved for DC voltage in accordance with UL 248.

- Use a 1 A fuse (time delay) before relay 1. Obey the [terminal description for X1](#) [[▶ 155](#)], pin 1.
- Provide the 24 V<sub>DC</sub> supply of the control unit with a 10 A fuse (time delay). Obey the [terminal description for X11](#) [[▶ 164](#)].
- Provide the 24 V<sub>DC</sub> supply for the brake with a 4 A fuse (time delay). Obey the [X6: Brake – Feedback and supply \(ST6 option\)](#) [[▶ 161](#)].
- For the STO safety function via terminal X12: Use a 4 A fuse (time delay) to protect the supply voltage of the status signal. Obey the [X12: Safety technology \(option ST6\)](#) [[▶ 165](#)].
- The following applies to interface extensions with terminal module XI6, RI6 or IO6: Protect the 24 V<sub>DC</sub> supply with a 1 A fuse (time delay). Obey the terminal description for X101, pin 18 or 19.

### Branch circuit protection

Integral solid state short circuit protection does not provide branch circuit protection (line fuse) upstream of the drive controller. Branch circuit protection must be provided in accordance with the manufacturer instructions, the National Electrical Code, the Canadian Electrical Code, part I, and any additional local codes.

### UL test

Only the risks of electric shock and the risk of fire have been examined during UL acceptance. Functional safety aspects have not been assessed during the UL approval process. These are assessed for STOBER by bodies such as the TÜV SÜD certification service.

# 6 System design

The SD6 drive controller features a modular interface concept that offers you the variable combination of all interface components (terminals, fieldbus, encoders and safety technology). For the communication between multiple drive controllers, the IGB motion bus isochronic system bus is available for multi-axis applications.

In multi-axis applications with decentralized motion control, we recommend the drive-based application Drive Based. Alternatively, you can implement the application using a CiA 402 interface. You commission the drive-controller using the DriveControlSuite software.

You can also connect multiple SD6 drive controllers in the DC link and thus improve the energy footprint of the entire system. For this purpose, you will need an appropriate Quick DC-Link module for each drive controller.

The drive controllers provide the STO safety function in accordance with EN 61800-5-2.

The following graphic explains the principle system design.

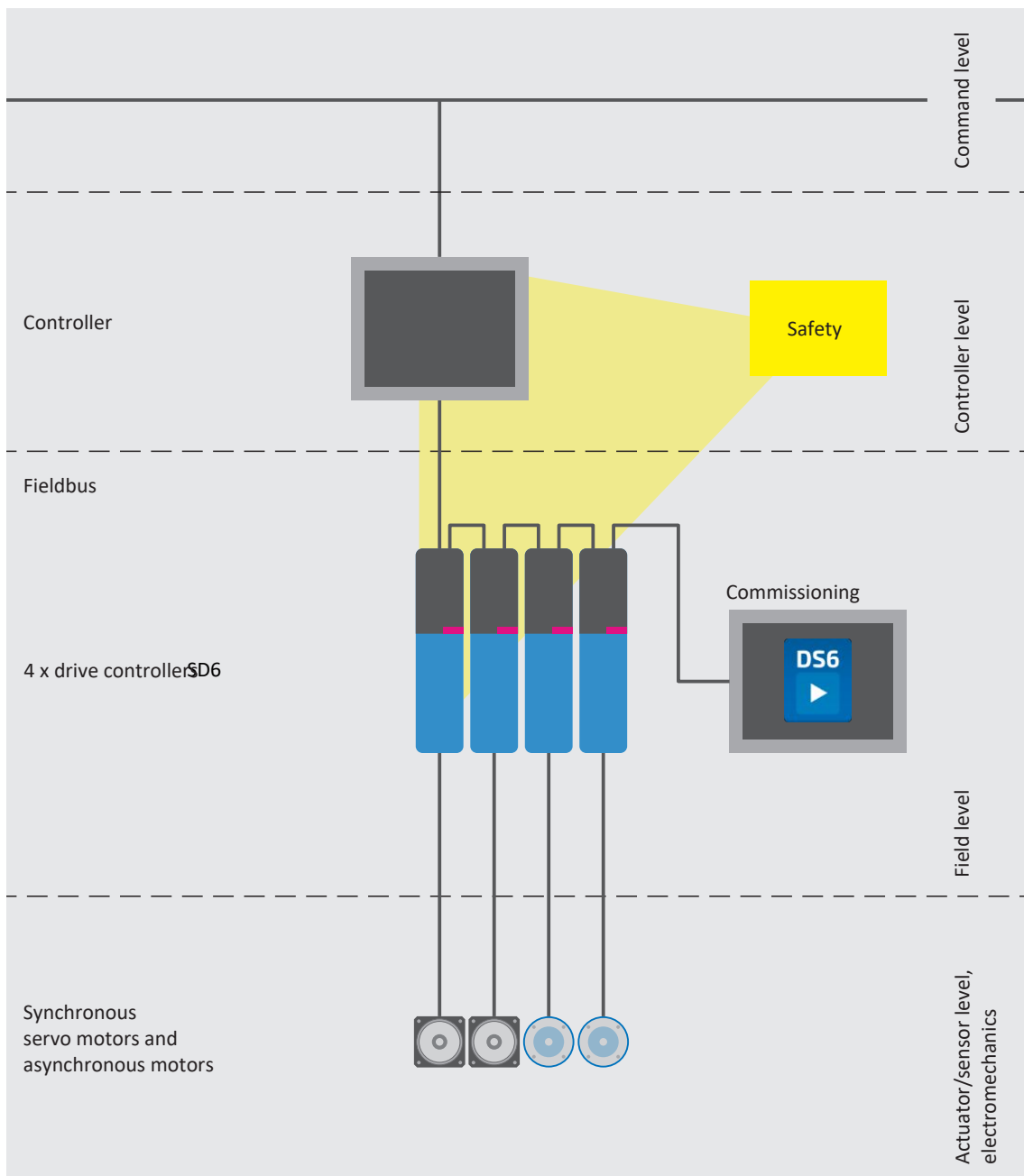

Fig. 2: System overview

## 6.1 Hardware components

Below you will find an overview of the available hardware components.

### 6.1.1 Drive controllers

The SD6 drive controller is available in multiple sizes. Various interface options can also be selected.

#### 6.1.1.1 Nameplate

The nameplate is placed on the side of the drive controller.



Fig. 3: SD6A06TEX nameplate

Designation	Value in example	Meaning
Type	SD6A06TEX	Production information
Date	2030 (year/calendar week)	
S/N	7002418	
Input voltage	3 × 400 V <sub>AC</sub> 50 Hz UL: 3 × 480 V <sub>AC</sub> 50–60 Hz	Input voltage
Input current	4.0 A	Input current
Output data	0 to 460 V <sub>AC</sub> 0 to 700 Hz @8 kHz: 3.4 A	Output voltage Output frequency Output current for 8 kHz clock frequency
Protection class	IP20	Protection class

Tab. 4: Meaning of the specifications on the nameplate

<b>Information</b>
--------------------

UL and cUL certified devices with the corresponding test symbol meet the requirements of standards UL 508C and UL 840.

### 6.1.1.2 Type designation

<b>SD</b>	<b>6</b>	<b>A</b>	<b>0</b>	<b>6</b>	<b>T</b>	<b>E</b>	<b>X</b>
-----------	----------	----------	----------	----------	----------	----------	----------

Tab. 5: Example code for type designation

Code	Designation	Design
<b>SD</b>	Series	
<b>6</b>	Generation	Generation 6
<b>A, B</b>	Version	
<b>0 – 3</b>	Size	
<b>6 (0 – 9)</b>	Power output stage	Power output stage within the size
<b>T</b>	Safety module	ST6: STO via terminals
<b>E</b>		SE6: Expanded safety functionality via terminals
<b>N</b>	Communication module	Empty
<b>E</b>		EC6: EtherCAT
<b>C</b>		CA6: CANopen
<b>P</b>		PN6: PROFINET
<b>N</b>	Terminal module	Empty
<b>X</b>		XI6: Extended
<b>R</b>		RI6: Resolver
<b>I</b>		IO6: Standard

Tab. 6: Meaning of the example code

### 6.1.1.3 Material variant

On the side of the drive controller above the nameplate, there is another sticker with the material variant (MV) and serial number (SN).



Fig. 4: Sticker with MV and serial number

Designation	Value in example	Meaning
MV	MV0000012345	MV number
SN	6001192064	Serial number
—	SD6A06TEX	Device type according to type designation
—	1000914812/001100	Order number/order item

Tab. 7: Meaning of the specifications on the sticker

## 6.1.1.4 Sizes

Type	Size
SD6A02	Size 0
SD6A04	Size 0
SD6A06	Size 0
SD6A14	Size 1
SD6A16	Size 1
SD6A24	Size 2
SD6A26	Size 2
SD6A34	Size 3
SD6A36	Size 3
SD6A38	Size 3

Tab. 8: Available SD6 types and sizes



SD6 in sizes 0, 1, 2 and 3

## 6.1.2 Operating motors, encoders and brakes

You can use the SD6 drive controller to operate synchronous servo motors (such as the EZ series), asynchronous motors, torque motors or linear motors.

Evaluation options for feedback are available at the X4 connection for the following encoder models:

- EnDat 2.1/2.2 digital encoders
- SSI encoders
- Differential HTL and differential TTL incremental encoder

The following additional encoder models can be connected using optional terminal modules:

- Resolver
- EnDat 2.1 sin/cos encoders
- Sin/cos encoders
- Single-ended HTL, single-ended TTL incremental encoder
- Single-ended HTL, single-ended TTL pulse/direction interface

For the commutation finding process for linear motors without an absolute measuring system, Hall sensor signals can be connected using the optionally available LA6 adapter box.

All device types of the SD6 drive controller feature connections for PTC thermistors, KTY or Pt1000 temperature sensors and can control a 24 V<sub>DC</sub> brake as standard.

## 6.1.3 Accessories

You can find information about the available accessories in the following chapters.

### 6.1.3.1 Safety technology

The safety modules are used to realize the STO safety function. They prevent the generation of a rotating magnetic field in the power unit of the drive controller. For an external requirement or in the event of error, the safety module switches the drive controller to the STO state. Different human-machine interfaces and additional safety functions are available depending on the selected design of the accessories.

#### Information

The drive controller is delivered with the ST6 safety module in the standard design. If you want a drive controller with advanced safety technology, you must order it together with the drive controller. The safety modules are an integrated part of the drive controllers and must not be modified.

#### ST6 safety module – STO using terminals

Included in the standard version.



ID No. 56431

Accessory for the use of the Safe Torque Off safety function (STO) in safety-relevant applications (PL e, SIL 3) in accordance with EN ISO 13849-1 and EN 61800-5-2. Connection to a higher-level safety circuit via terminal X12.

#### SE6 safety module – Expanded safety functionality via terminals



ID No. 56432

Optional accessory for use in safety-related applications up to PL e, SIL 3 in accordance with EN ISO 13849-1 and EN 61800-5-2. In addition to the basic Safe Torque Off (STO) safety function, SE6 provides other safety functions specified in EN 61800-5-2. In addition to the safe stop functions Safe Stop 1 (SS1) and Safe Stop 2 (SS2), these also include Safely-Limited Speed (SLS), Safe Brake Control (SBC), Safe Direction (SDI) and Safely-Limited Increment (SLI). The normative safety functions are supplemented by practical additional functions such as Safe Brake Test (SBT). Connection to the higher-level safety circuit using terminals X14 and X15.

#### X50 adapter cable (SE6 option)



ID No. 56434

Adapter cable for the X50 encoder interface of the SE6 safety module with open cable ends, length: 1.5 m.

For detailed information about using the safety technology, refer to the corresponding manual (see [Detailed information](#) [▶ 476]).



### 6.1.3.2 Communication

The SD6 drive controller has two interfaces for IGB communication on the top of the device as standard. The communication module is installed in the shaft at the top and it is used to connect the drive controller to the fieldbus system.

The following communication modules are available:

- EC6 for the EtherCAT connection
- CA6 for the CANopen connection
- PN6 for the PROFINET connection

#### IGB connecting cable



Cable for connecting the X3A or X3B interface for IGB, CAT5e, magenta.

The following designs are available:

ID No. 56489: 0.4 m.

ID No. 56490: 2 m.

#### PC connecting cables



ID No. 49857

Cable for connecting the X3A or X3B interface with the PC, CAT5e, blue, length: 5 m.

#### USB 2.0 Ethernet adapter



ID No. 49940

Adapter for connecting Ethernet to a USB port.

#### EC6 communication module

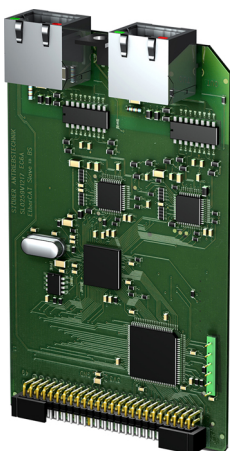

ID No. 138425

Communication module for the EtherCAT connection.

### EtherCAT cables



Ethernet patch cable, CAT5e, yellow.

The following designs are available:

ID No. 49313: Length approx. 0.25 m.

ID No. 49314: Length approx. 0.5 m.

### CA6 communication module

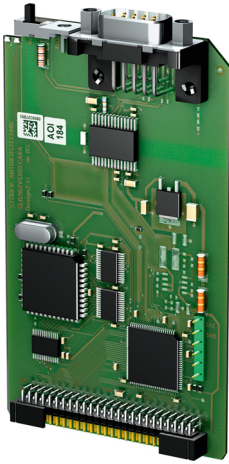

ID No. 138427

Communication module for the CANopen connection.

### PN6 communication module

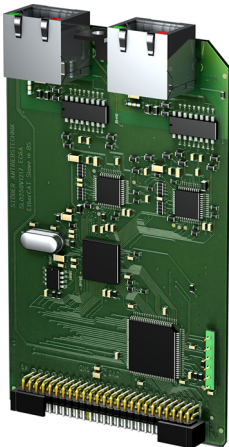

ID No. 138426

Communication module for the PROFINET connection.

For detailed information about the fieldbus connection, refer to the corresponding manual (see [Detailed information](#) [▶ 476]).

### 6.1.3.3 Terminal module

#### XI6 terminal module

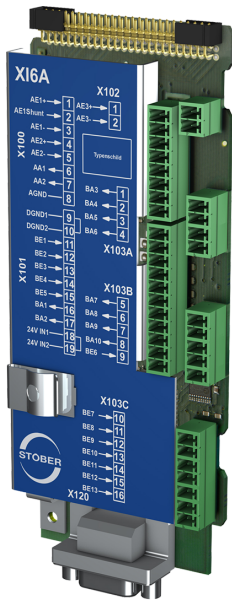

ID no. 138421

Terminal module for connecting analog and digital signals as well as encoders.

Supported inputs and outputs:

- 13 digital inputs ( $24 V_{DC}$ )
- 10 digital outputs ( $24 V_{DC}$ )
- 3 analog inputs ( $\pm 10 V_{DC}$ ,  $1 \times 0 - 20 \text{ mA}$ , 16 bits)
- 2 analog outputs ( $\pm 10 V_{DC}$ , 12 bits)

Supported encoders / interfaces:

- SSI encoder (simulation and evaluation)
- TTL incremental encoder, differential (simulation and evaluation)
- HTL incremental encoder, single-ended (simulation and evaluation)
- TTL pulse/direction interface, differential (simulation and evaluation)
- HTL pulse/direction interface, single-ended (simulation and evaluation)

## RI6 terminal module



ID no. 138422

Terminal module for connecting analog and digital signals as well as encoders.

Supported inputs and outputs:

- 5 digital inputs ( $24 V_{DC}$ )
- 2 digital outputs ( $24 V_{DC}$ )
- 2 analog inputs ( $\pm 10 V_{DC}$ ,  $1 \times 0 - 20 \text{ mA}$ , 16 bits)
- 2 analog outputs ( $\pm 10 V_{DC}$ ,  $\pm 20 \text{ mA}$ , 12 bits)

Supported encoders / interfaces:

- Resolver (evaluation)
- EnDat 2.1 sin/cos encoder (evaluation)
- EnDat 2.1/2.2 digital encoder (evaluation)
- Sin/cos encoder (evaluation)
- SSI encoder (simulation and evaluation)
- TTL incremental encoder, differential (simulation and evaluation)
- TTL incremental encoder, single-ended (evaluation)
- HTL incremental encoder, single-ended (simulation and evaluation)
- TTL pulse/direction interface, differential (simulation and evaluation)
- TTL pulse/direction interface, single-ended (evaluation)
- HTL pulse/direction interface, single-ended (simulation and evaluation)

### Information

For connecting STOBER resolver cables with a 9-pin D-sub connector, such as the standard design for ED/EK synchronous servo motors, you must use the AP6A00 (ID No. 56498) or AP6A01 (ID No. 56522) interface adapter, available separately.

### Information

For connecting STOBER EnDat 2.1 sin/cos cables with a 15-pin D-sub connector to an integrated motor temperature sensor, you must use the AP6A02 interface adapter (ID No. 56523), available separately, to lead out the temperature sensor cores.

## AP6 interface adapters



The following variants are available:

### AP6A00

ID No. 56498

Adapter X140 resolver, 9/15-pin.

Adapters for connecting resolver cables with a 9-pin D-sub connector to the X140 encoder interface of the RI6 terminal module.

### AP6A01

ID No. 56522

Adapter X140 resolver, 9/15-pin with separate motor temperature sensor leads.

Adapters for connecting resolver cables with a 9-pin D-sub connector to the X140 encoder interface of the RI6 terminal module.

### AP6A02

ID No. 56523

Adapter X140 EnDat 2.1 sin/cos, 15/15-pin with separate motor temperature sensor leads.

Adapters for connecting EnDat 2.1 sin/cos cables with a 15-pin D-sub connector to the X140 encoder interface of the RI6 terminal module.

## IO6 terminal module



ID no. 138420

Terminal module for connecting analog and digital signals as well as encoders.

Supported inputs and outputs:

- 5 digital inputs ( $24 V_{DC}$ )
- 2 digital outputs ( $24 V_{DC}$ )
- 2 analog inputs ( $\pm 10 V_{DC}$ ,  $1 \times 0 - 20 \text{ mA}$ , 12 bits)
- 2 analog outputs ( $\pm 10 V_{DC}$ ,  $\pm 20 \text{ mA}$ , 12 bits)

Supported encoders / interfaces:

- HTL incremental encoder, single-ended (simulation and evaluation)
- HTL pulse/direction interface, single-ended (simulation and evaluation)

### 6.1.3.4 DC link connection

If you want to connect SD6 drive controllers in the DC link group, you will need Quick DC-Link modules of type DL6A.

You receive the DL6A rear section modules in different designs for a horizontal connection, suitable for the size of the drive controller.

The quick fastening clamps for attaching the copper rails and an insulation connection piece are contained in the scope of delivery. The copper rails are not included in the scope of delivery. These must have a cross-section of 5 x 12 mm. Insulation end sections are available separately.

#### DL6A Quick DC-Link for drive controllers

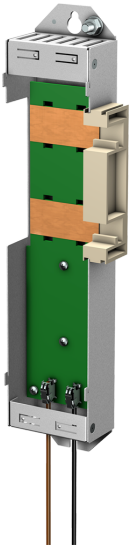

The following designs are available:

- DL6A0  
ID No. 56440  
Rear section module for size 0 drive controller.
- DL6A1  
ID No. 56441  
Rear section module for size 1 drive controller.
- DL6A2  
ID No. 56442  
Rear section module for size 2 drive controller.
- DL6A3  
ID No. 56443  
Rear section module for size 3 drive controller.

#### DL6A Quick DC-Link insulation end section

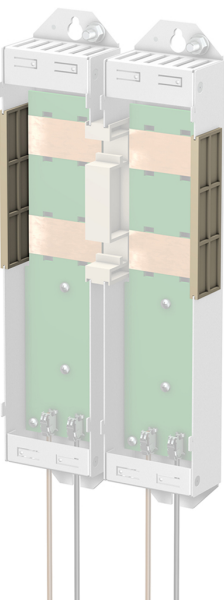

- ID No. 56494  
Insulation end sections for the left and right termination of the group, 2 pcs.

### 6.1.3.5 Braking resistor

STOBER offers braking resistors in different sizes and performance classes.

For more detailed information on this, refer to the technical data (see [Braking resistor \[▶ 81\]](#)).

### 6.1.3.6 Choke

STOBER offers various chokes corresponding to your application.

For more detailed information, refer to the technical data (see [Choke \[▶ 88\]](#)).

### 6.1.3.7 EMC shroud

You can use the EM6A EMC shroud to connect the cable shield of the power cable. Two different designs are available.

#### EM6A0 EMC shroud



ID No. 56459

EMC shroud for the SD6 drive controller up to size 2.

Accessory part for shield connection of the power cable.

Can be attached to the drive controller housing.

Including shield connection terminal.

#### EM6A3 EMC shroud

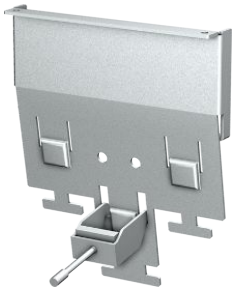

ID No. 56521

EMC shroud for drive controllers of the MDS 5000, SDS 5000 and SD6 series.

Accessory part for shield connection of the power cable for drive controllers up to size 3.

Can be attached to the drive controller housing.

Including shield connection terminal.

If necessary, you can also connect the cable shield of the braking resistor and DC link connection to the shroud.

### 6.1.3.8 Encoder adapter box

#### LA6A00 encoder adapter box



ID No. 56510

Interface adapter for differential TTL incremental signals and single-ended TTL Hall sensor signals.

The adapter converts and transmits TTL signals from synchronous linear motors to the SD6 drive controller. A variable, internal interface converts the input signals appropriately for the STOBER standard interfaces.

#### X120 SSI/TTL connecting cable



ID No. 49482

Cable for connecting the X120 TTL interface on the SD6 drive controller (on terminal module RI6 or XI6) with the X301 interface on the LA6 adapter box in order to transfer Hall sensor signals, length: 0.3 m.

#### LA6 / AX 5000 connecting cable



Cable for connecting the X4 connection on the SD6 drive controller to X300 on the LA6 adapter box in order to transmit incremental encoder signals.

The following designs are available:

ID No. 45405: 0.5 m.

ID No. 45386: 2.5 m.



### 6.1.3.9 Encoder battery module

#### Absolute Encoder Support AES



ID No. 55452

Battery module for buffering the supply voltage when using the EnDat 2.2 digital inductive encoder with battery-buffered multi-turn stage, for example EBI1135 or EBI135.

A battery is included.

#### Information

Note that a 15-pin extension cable between the socket and the AES may be necessary for the connection to the drive controller due to limited space.

- A commercially available shielded extension cable with a 15-pin D-sub connector and a length of  $\leq 1$  m can be used between the socket and the AES.

#### AES replacement battery



ID No. 55453

Replacement battery for AES battery module.

### 6.1.3.10 Removable data storage

#### Paramodul removable data storage

Included in the standard version.



ID No. 56403

The plug-in Paramodul with integrated microSD card (from 512 MB, industrial type) is available as a storage medium.

## 6.2 Software components

The available software components help you implement your drive system.

### 6.2.1 Project configuration and parameterization

For project configuration and parameterization, the drive controller can be addressed using the DriveControlSuite commissioning software. The program guides you step by step through the complete project configuration and parameterization process using wizards.

### 6.2.2 Applications

A drive-based application is recommended for the decentralized motion control of sophisticated machines.

The drive-based application package from STOBER is the right choice wherever universal and flexible solutions are needed. The Drive Based Synchronous application provides drive-based motion control for synchronous operation, positioning, velocity and torque/force with the PLCopen Motion Control command set. These standard commands have been combined into operating modes for different application cases and supplemented with additional functions such as motion block linking or cams. For the command operating mode, all properties of the movements are specified directly by the controller. The properties of the movements in the drive are predefined in the motion block operating mode so that only a start signal is necessary to perform the movement. Linking can be used to define complete motion sequences.

In addition, the CiA 402 application is also available, which includes both the controller-based and drive-based operating modes (csp, csv, cst, ip, pp, pv, pt).

Furthermore, programming based on IEC 61131-3 with CFC can be used to create new applications or expand existing ones.

For detailed information about the available applications, refer to the corresponding manual (see [Detailed information](#) [▶ 476]).

## 7 Technical data

Technical data for the drive controllers and accessories can be found in the following chapters.

### 7.1 Drive controllers

The following chapters contain specifications for the electrical data, dimensions and weight of the drive controller.

#### 7.1.1 General technical data

The following information applies to all device types.

Device features	
Protection class of the device	IP20
Protection class of the installation space	At least IP54
Protection class	Protection class I in accordance with EN 61140
Radio interference suppression	Integrated line filter in accordance with EN 61800-3, interference emission class C3
Overvoltage category	III in accordance with EN 61800-5-1
Marks and test symbols	CE, cULus, RoHS

Tab. 9: Device features

Transport and storage conditions	
Storage/ transport temperature	-20 °C to +70 °C Maximum change: 20 K/h
Relative humidity	Maximum relative humidity 85%, non-condensing
Vibration (transport) in accordance with EN 60068-2-6	5 Hz ≤ f ≤ 9 Hz: 3.5 mm 9 Hz ≤ f ≤ 200 Hz: 10 m/s <sup>2</sup> 200 Hz ≤ f ≤ 500 Hz: 15 m/s <sup>2</sup>
Fall height for freefall <sup>1</sup> Weight < 100 kg in accordance with EN 61800-2 (or IEC 60721-3-2, class 2M1)	0.25 m

Tab. 10: Transport and storage conditions

Operating conditions	
Surrounding temperature during operation	0 °C to 45 °C with nominal data 45 °C to 55 °C with derating -2.5% / K
Relative humidity	Maximum relative humidity 85%, non-condensing
Installation altitude	0 m to 1000 m above sea level without restrictions 1000 m to 2000 m above sea level with -1.5%/100 m derating
Pollution degree	Pollution degree 2 in accordance with EN 50178
Ventilation	Installed fan
Vibration (operation) in accordance with EN 60068-2-6	5 Hz ≤ f ≤ 9 Hz: 0.35 mm 9 Hz ≤ f ≤ 200 Hz: 1 m/s <sup>2</sup>

Tab. 11: Operating conditions

Discharge times	
Self-discharge of DC link	6 min

Tab. 12: Discharge times of the DC link circuit

<sup>1</sup> Only valid for components in original packaging

## 7.1.2 Electrical data

The electrical data of the available SD6 sizes as well as the properties of the brake chopper can be found in the following chapters.

### Information

For the time span between energizing two devices, note that:

- Direct, repeat activation of the supply voltage is possible for cyclical power-on/power-off operation.

### Information

The STO safety function is available for safe stopping as an alternative to continuous, cyclical power-on/power-off operation.

For an explanation of the formula symbols used, see [Symbols in formulas \[▶ 478\]](#).

### 7.1.2.1 Control unit

Electrical data	All types
$U_{1CU}$	$24 V_{DC}, +20\%/-15\%$
$I_{1maxCU}$	1.5 A

Tab. 13: Control unit electrical data

### 7.1.2.2 Power unit: Size 0

Electrical data	SD6A02	SD6A04	SD6A06
$U_{1PU}$	$1 \times 230 V_{AC},$ $+20\% / -40\%,$ $50/60 \text{ Hz}$	$3 \times 400 V_{AC},$ $+32\% / -50\%, 50/60 \text{ Hz};$ $3 \times 480 V_{AC},$ $+10\% / -58\%, 50/60 \text{ Hz}$	
$f_{2PU}$	0 – 700 Hz		
$U_{2PU}$	0 – max. $U_{1PU}$		
$U_{2PU,ZK}$	$\sqrt{2} \times U_{1PU}$		
$C_{PU}$	340 $\mu\text{F}$	135 $\mu\text{F}$	135 $\mu\text{F}$
$C_{N,PU}$	1620 $\mu\text{F}$	540 $\mu\text{F}$	540 $\mu\text{F}$

Tab. 14: SD6 electrical data, size 0

#### Nominal currents up to +45 °C (in the control cabinet)

Electrical data	SD6A02	SD6A04	SD6A06
$f_{PWM,PU}$	4 kHz		
$I_{1N,PU}$	8.3 A	2.8 A	5.4 A
$I_{2N,PU}$	4 A	2.3 A	4.5 A
$I_{2maxPU}$	180% for 5 s; 150% for 30 s		

Tab. 15: SD6 electrical data, size 0, for 4 kHz clock frequency

Electrical data	SD6A02	SD6A04	SD6A06
$f_{PWM,PU}$	8 kHz		
$I_{1N,PU}$	6 A	2.2 A	4 A
$I_{2N,PU}$	3 A	1.7 A	3.4 A
$I_{2maxPU}$	250% for 2 s; 200% for 5 s		

Tab. 16: SD6 electrical data, size 0, for 8 kHz clock frequency

Electrical data	SD6A02	SD6A04	SD6A06
$U_{onCH}$	400 – 420 V <sub>DC</sub>	780 – 800 V <sub>DC</sub>	
$U_{offCH}$	360 – 380 V <sub>DC</sub>	740 – 760 V <sub>DC</sub>	
$R_{2minRB}$	100 Ω		
$P_{maxRB}$	1.8 kW	6.4 kW	
$P_{effRB}$	1.0 kW	2.9 kW	

Tab. 17: Brake chopper electrical data, size 0

### 7.1.2.3 Power unit: Size 1

Electrical data	SD6A14	SD6A16
$U_{1PU}$	3 × 400 V <sub>ACr</sub> +32% / -50%, 50/60 Hz; 3 × 480 V <sub>ACr</sub> +10% / -58%, 50/60 Hz	
$f_{2PU}$	0 – 700 Hz	
$U_{2PU}$	0 – max. $U_{1PU}$	
$U_{2PU,ZK}$	$\sqrt{2} \times U_{1PU}$	
$C_{PU}$	470 μF	560 μF
$C_{N,PU}$	1400 μF	1400 μF

Tab. 18: SD6 electrical data, size 1

#### Nominal currents up to +45 °C (in the control cabinet)

Electrical data	SD6A14	SD6A16
$f_{PWM,PU}$	4 kHz	
$I_{1N,PU}$	12 A	19.2 A
$I_{2N,PU}$	10 A	16 A
$I_{2maxPU}$	180% for 5 s; 150% for 30 s	

Tab. 19: SD6 electrical data, size 1, for 4 kHz clock frequency

Electrical data	SD6A14	SD6A16
$f_{PWM,PU}$	8 kHz	
$I_{1N,PU}$	9.3 A	15.8 A
$I_{2N,PU}$	6 A	10 A
$I_{2maxPU}$	250% for 2 s; 200% for 5 s	

Tab. 20: SD6 electrical data, size 1, for 8 kHz clock frequency

Electrical data	SD6A14	SD6A16
$U_{\text{onCH}}$	780 – 800 V <sub>DC</sub>	
$U_{\text{offCH}}$	740 – 760 V <sub>DC</sub>	
$R_{2\text{minRB}}$	47 Ω	
$P_{\text{maxRB}}$	13.6 kW	
$P_{\text{effRB}}$	6.2 kW	

Tab. 21: Brake chopper electrical data, size 1

## 7.1.2.4 Power unit: Size 2

Electrical data	SD6A24	SD6A26
$U_{1\text{PU}}$	3 × 400 V <sub>AC</sub> , +32% / -50%, 50/60 Hz; 3 × 480 V <sub>AC</sub> , +10% / -58%, 50/60 Hz	
$f_{2\text{PU}}$	0 – 700 Hz	
$U_{2\text{PU}}$	0 – max. $U_{1\text{PU}}$	
$U_{2\text{PU,ZK}}$	$\sqrt{2} \times U_{1\text{PU}}$	
$C_{\text{PU}}$	680 μF	1000 μF
$C_{\text{N,PU}}$	1400 μF	1400 μF

Tab. 22: SD6 electrical data, size 2

## Nominal currents up to +45 °C (in the control cabinet)

Electrical data	SD6A24	SD6A26
$f_{\text{PWM,PU}}$	4 kHz	
$I_{1\text{N,PU}}$	26.4 A	38.4 A
$I_{2\text{N,PU}}$	22 A	32 A
$I_{2\text{maxPU}}$	180% for 5 s; 150% for 30 s	

Tab. 23: SD6 electrical data, size 2, for 4 kHz clock frequency

Electrical data	SD6A24	SD6A26
$f_{\text{PWM,PU}}$	8 kHz	
$I_{1\text{N,PU}}$	24.5 A	32.6 A
$I_{2\text{N,PU}}$	14 A	20 A
$I_{2\text{maxPU}}$	250% for 2 s; 200% for 5 s	

Tab. 24: SD6 electrical data, size 2, for 8 kHz clock frequency

Electrical data	SD6A24	SD6A26
$U_{\text{onCH}}$	780 – 800 V <sub>DC</sub>	
$U_{\text{offCH}}$	740 – 760 V <sub>DC</sub>	
$R_{2\text{minRB}}$	22 Ω	
$P_{\text{maxRB}}$	29.1 kW	
$P_{\text{effRB}}$	13.2 kW	

Tab. 25: Brake chopper electrical data, size 2

## 7.1.2.5 Power unit: Size 3

Electrical data	SD6A34	SD6A36	SD6A38
$U_{1PU}$	3 × 400 V <sub>AC</sub> +32% / -50%, 50/60 Hz; 3 × 480 V <sub>AC</sub> +10% / -58%, 50/60 Hz		
$f_{2PU}$	0 – 700 Hz		
$U_{2PU}$	0 – max. $U_{1PU}$		
$U_{2PU,ZK}$	$\sqrt{2} \times U_{1PU}$		
$C_{PU}$	430 μF	900 μF	900 μF
$C_{N,PU}$	5100 μF	5100 μF	5100 μF

Tab. 26: SD6 electrical data, size 3

## Nominal currents up to +45 °C (in the control cabinet)

Electrical data	SD6A34	SD6A36	SD6A38
$f_{PWM,PU}$	4 kHz		
$I_{1N,PU}$	45.3 A	76 A	76 A
$I_{2N,PU}$	44 A	70 A	85 A <sup>2</sup>
$I_{2maxPU}$	180% for 5 s; 150% for 30 s		

Tab. 27: SD6 electrical data, size 3, for 4 kHz clock frequency

Electrical data	SD6A34	SD6A36	SD6A38
$f_{PWM,PU}$	8 kHz		
$I_{1N,PU}$	37 A	62 A	76 A
$I_{2N,PU}$	30 A	50 A	60 A
$I_{2maxPU}$	250% for 2 s; 200% for 5 s		

Tab. 28: SD6 electrical data, size 3, for 8 kHz clock frequency

Electrical data	SD6A34	SD6A36	SD6A38
$U_{onCH}$	780 – 800 V <sub>DC</sub>		
$U_{offCH}$	740 – 760 V <sub>DC</sub>		
$R_{intRB}$	30 Ω (PTC resistance; 100 W; max. 1 kW for 1 s; τ = 40 s)		
$R_{2minRB}$	15 Ω		
$P_{maxRB}$	42 kW		
$P_{effRB}$	19.4 kW		

Tab. 29: Brake chopper electrical data, size 3

<b>Information</b>
--------------------

Be aware that the internal braking resistor is not active automatically and must be parameterized in DriveControlSuite.

<sup>2</sup> Specification applies to the default value of the field weakening voltage limit: B92 = 80%.

### 7.1.2.6 Enable and relay

You enable the power unit of the drive controller using the enable signal. The function of relay 1 can be parameterized using parameter F75.

Electrical data		All types
Internal device update rate		Cycle time parameterized in A150 of the application: $t_{\min} = 1 \text{ ms}$
$U_{2\max}$	Relay 1	30 V
$I_{2\max}$		1.0 A
Life span		Mechanical min. 5,000,000 switching cycles; at 24 V <sub>DC</sub> /1 A (ohm. load): 300,000 switching cycles
High level	Enable	12 – 30 V <sub>DC</sub>
Low level		0 – 8 V <sub>DC</sub>
$I_{1\max}$		16 mA

Tab. 30: X1 electrical data

### 7.1.2.7 DC link connection

The charging capacity of the drive controllers can be increased by a DC link connection only if the power grid supply is connected to all drive controllers simultaneously.

Obey the general conditions for DC link connection (see [Project configuration](#) [► 93]).



7.1.2.8 Power loss data in accordance with EN 61800-9-2

Type	Nominal current $I_{2N,PU}$	Apparent power	Absolute losses $P_{V,CU}^3$	Operating points <sup>4</sup>								IE class <sup>5</sup>	Comparison <sup>6</sup>
				(0/25)	(0/50)	(0/100)	(50/25)	(50/50)	(50/100)	(90/50)	(90/100)		
				Relative losses									
				[%]									
	[A]	[kVA]	[W]										
SD6A02	4	0.9	10	5.01	5.07	5.68	5.20	5.37	6.30	5.88	7.43	IE2	
SD6A04	2.3	1.6	10	2.98	3.13	3.49	3.02	3.22	3.71	3.36	4.09	IE2	
SD6A06	4.5	3.1	12	1.71	1.86	2.24	1.75	1.97	2.51	2.16	3.04	IE2	
SD6A14	10	6.9	12	1.38	1.54	1.93	1.43	1.64	2.17	1.80	2.57	IE2	
SD6A16	16	11.1	12	0.95	1.12	1.66	0.99	1.23	1.98	1.41	2.52	IE2	
SD6A24	22	15.2	15	0.80	0.97	1.49	0.84	1.06	1.75	1.21	2.19	IE2	
SD6A26	32	22.2	15	0.70	0.87	1.40	0.74	0.97	1.67	1.11	2.10	IE2	
SD6A34	44	30.5	35	0.61	0.76	1.21	0.68	0.90	1.53	1.06	1.96	IE2	
SD6A36	70	48.5	35	0.53	0.69	1.18	0.59	0.82	1.49	0.97	1.89	IE2	
SD6A38	85	58.9	35	0.47	0.64	1.18	0.54	0.78	1.50	0.94	1.94	IE2	

<sup>3</sup> Absolute losses for a power unit that is switched off

<sup>4</sup> Operating points for relative motor stator frequency in % and relative torque current in %

<sup>5</sup> IE class in accordance with EN 61800-9-2

<sup>6</sup> Comparison of the losses for the reference related to IE2 in the nominal point (90, 100)

Type	Nominal current $I_{2N,PU}$	Apparent power	Absolute losses $P_{V,CU}^3$	Operating points <sup>4</sup>								IE class <sup>5</sup>	Comparison <sup>6</sup>
				(0/25)	(0/50)	(0/100)	(50/25)	(50/50)	(50/100)	(90/50)	(90/100)		
				Absolute losses $P_V$									
			[A]	[kVA]	[W]	[W]							[%]
SD6A02	4	0.9	10	45.1	45.6	51.1	46.8	48.3	56.7	52.9	66.9	IE2	51.8
SD6A04	2.3	1.6	10	47.7	50.1	55.8	48.3	51.5	59.3	53.8	65.4	IE2	40.2
SD6A06	4.5	3.1	12	52.9	57.6	69.3	54.4	61.0	77.9	67.1	94.1	IE2	39.6
SD6A14	10	6.9	12	95.3	106.1	133.3	98.6	113.2	149.9	123.9	177.0	IE2	37.1
SD6A16	16	11.1	12	104.9	124.0	184.6	110.3	136.6	219.8	156.0	279.8	IE2	35.8
SD6A24	22	15.2	15	121.5	146.9	226.1	128.1	161.6	266.0	183.7	332.7	IE2	32.9
SD6A26	32	22.2	15	154.7	192.8	311.3	164.7	214.9	370.5	246.9	465.9	IE2	38.6
SD6A34	44	30.5	35	187.5	232.2	368.7	207.7	273.9	466.8	323.0	597.8	IE2	32.1
SD6A36	70	48.5	35	256.6	332.3	570.8	287.9	397.0	721.5	471.0	915.9	IE2	33.9
SD6A38	85	58.9	35	277.8	376.9	692.3	317.4	459.0	886.1	554.6	1143.1	IE2	35.3

Tab. 31: Power loss data of the SD6 drive controller in accordance with EN 61800-9-2

### General conditions

The loss data applies to drive controllers without any accessories.

The power loss calculation is based on a three-phase supply voltage with 400 V<sub>AC</sub>/50 Hz.

The calculated data includes a supplement of 10% in accordance with EN 61800-9-2.

The power loss specifications refer to a clock frequency of 4 kHz.

The absolute losses for a power unit that is switched off refer to the 24 V<sub>DC</sub> power supply of the control electronics.

### 7.1.2.9 Power loss data of accessories

If you intend to order the drive controller with accessory parts, losses increase as follows:

Type	Absolute losses $P_v$ [W]
SE6 safety module	< 4
ST6 safety module	1
IO6 terminal module	< 2
XI6 terminal module	< 5
RI6 terminal module	< 5
CA6 communication module	1
EC6 communication module	< 2
PN6 communication module	< 4

Tab. 32: Absolute losses of the accessories

#### Information

Note the absolute power loss of the encoder (usually < 3 W) and of the brake when designing as well.

Loss specifications for other optional accessories can be found in the technical data of the respective accessory part.

## 7.1.3 Derating

When dimensioning the drive controller, observe the derating of the nominal output current as a function of the clock frequency, surrounding temperature and installation altitude. There is no restriction for a surrounding temperature from 0 °C to 45 °C and an installation altitude of 0 m to 1000 m. The details given below apply to values outside these ranges.

### 7.1.3.1 Effect of the clock frequency

Changing the clock frequency  $f_{\text{PWM}}$  affects the amount of noise produced by the drive, among other things. However, increasing the clock frequency results in increased losses. During project configuration, define the highest clock frequency and use it to determine the nominal output current  $I_{2N,PU}$  for dimensioning the drive controller.

Type	$I_{2N,PU}$ 4 kHz	$I_{2N,PU}$ 8 kHz	$I_{2N,PU}$ 16 kHz
SD6A02	4 A	3 A	2 A
SD6A04	2.3 A	1.7 A	1.1 A
SD6A06	4.5 A	3.4 A	2.3 A
SD6A14	10 A	6 A	4 A
SD6A16	16 A	10 A	5.7 A
SD6A24	22 A	14 A	8.1 A
SD6A26	32 A	20 A	12 A
SD6A34	44 A	30 A	18 A
SD6A36	70 A	50 A	31 A
SD6A38	85 A <sup>7</sup>	60 A	37.8 A

Tab. 33: Nominal output current  $I_{2N,PU}$  dependent on the clock frequency

#### Information

Select the defined clock frequency using parameter B24.

<sup>7</sup>Specification applies to the default value of the field weakening voltage limit: B92 = 80%.

### 7.1.3.2 Effect of the surrounding temperature

Derating as a function of the surrounding temperature is determined as follows:

- 0 °C to 45 °C: No restrictions ( $D_T = 100\%$ )
- 45 °C to 55 °C: Derating  $-2.5\%/K$

#### Example

The drive controller needs to be operated at 50 °C.

The derating factor  $D_T$  is calculated as follows

$$D_T = 100\% - 5 \times 2.5\% = 87.5\%$$

### 7.1.3.3 Effect of the installation altitude

Derating as a function of the installation altitude is determined as follows:

- 0 m to 1000 m: No restriction ( $D_{IA} = 100\%$ )
- 1000 m to 2000 m: Derating  $-1.5\%/100\text{ m}$

#### Example

The drive controller needs to be installed at an altitude of 1500 m above sea level.

The derating factor  $D_{IA}$  is calculated as follows:

$$D_{IA} = 100\% - 5 \times 1.5\% = 92.5\%$$

### 7.1.3.4 Calculating the derating

Follow these steps for the calculation:

1. Determine the highest clock frequency ( $f_{PWM}$ ) that will be used during operation and use it to determine the nominal current  $I_{2N,PU}$ .
2. Determine the derating factors for installation altitude and surrounding temperature.
3. Calculate the reduced nominal current  $I_{2N,PU(red)}$  in accordance with the following formula:

$$I_{2N,PU(red)} = I_{2N,PU} \times D_T \times D_{IA}$$

#### Example

A drive controller of type SD6A06 needs to be operated at a clock frequency of 8 kHz at an altitude of 1500 m above sea level and a surrounding temperature of 50 °C.

The nominal current of the SD6A06 at 8 kHz is 3.4 A. The derating factor  $D_T$  is calculated as follows:

$$D_T = 100\% - 5 \times 2.5\% = 87.5\%$$

The derating factor  $D_{IA}$  is calculated as follows:

$$D_{IA} = 100\% - 5 \times 1.5\% = 92.5\%$$

The output current of importance for the project configuration is:

$$I_{2N,PU(red)} = 3.4\text{ A} \times 0.875 \times 0.925 = 2.75\text{ A}$$

### 7.1.4 Dimensions

The dimensions of the available SD6 sizes can be found in the following chapters.

#### 7.1.4.1 Dimensions: sizes 0 to 2

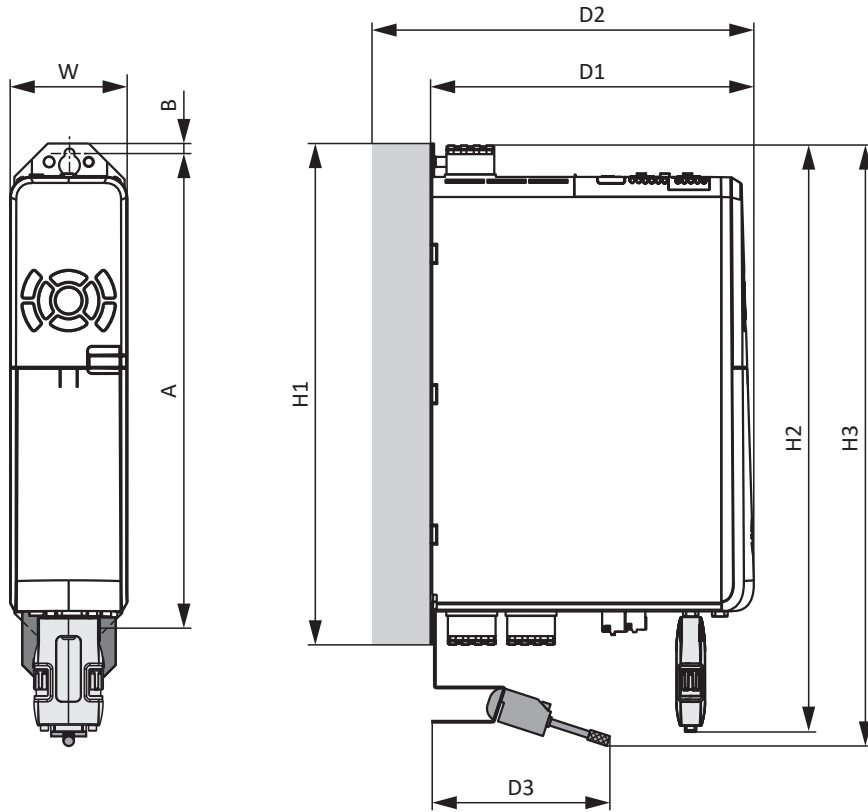

Fig. 5: SD6 dimensional drawing, sizes 0 to 2

Dimension			Size 0	Size 1	Size 2
Drive controller	Width	W	70	70	105
	Depth	D1	194	284	
	Depth incl. RB 5000 braking resistor	D2	212	302	
	Depth incl. Quick DC-Link	D2	229	319	
	Height incl. fastening clips	H1	300		
	Height incl. AES	H2	367		
	Height incl. EMC shroud	H3	approx. 376		
EMC shroud incl. shield connection terminal	Depth	D3	approx. 111		
Fastening holes	Vertical distance	A	283+2		
	Vertical distance to the upper edge	B	6		

Tab. 34: SD6 dimensions, sizes 0 to 2 [mm]

7.1.4.2 Dimensions: size 3

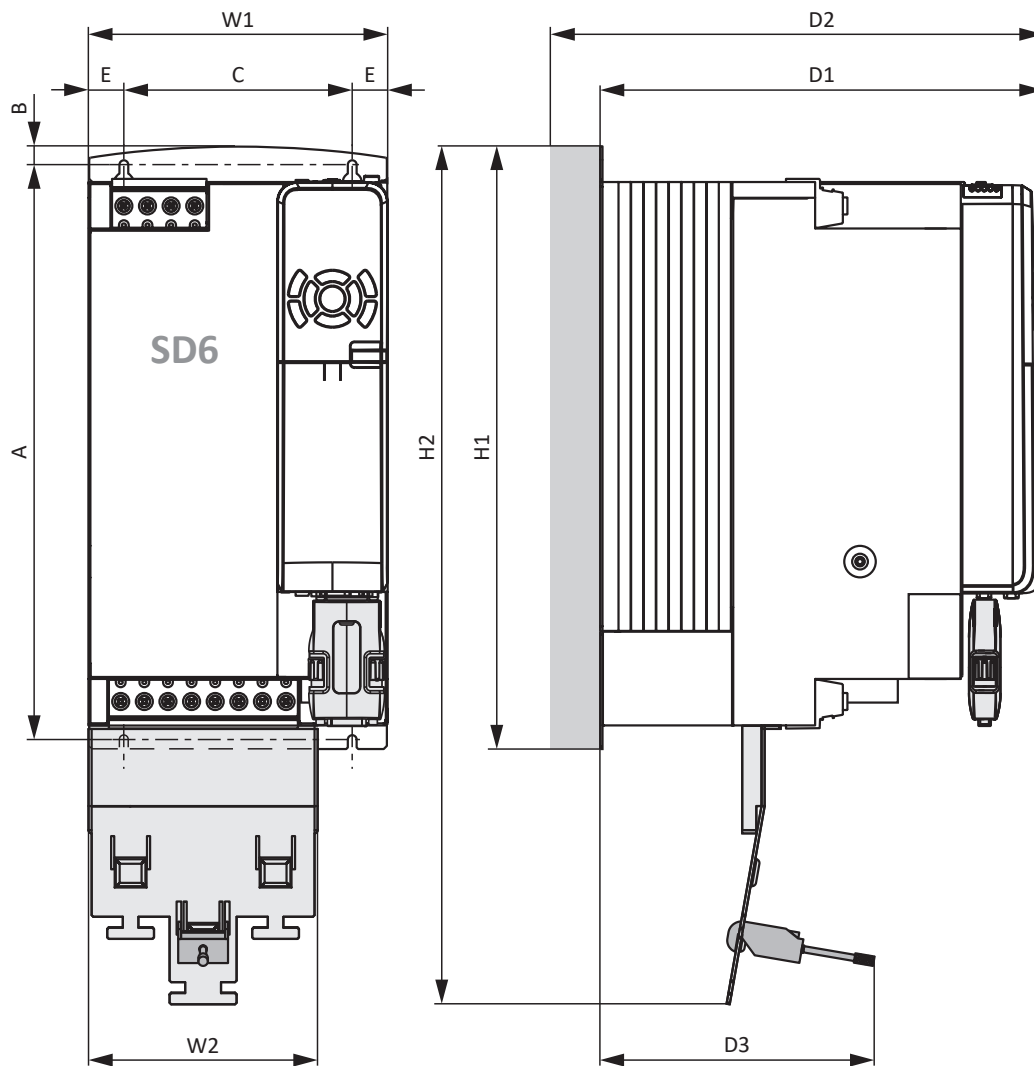

Fig. 6: SD6 dimensional drawing, size 3

Dimension		Size 3	
Drive controller	Width	W1	190
	Depth	D1	305
	Depth incl. Quick DC-Link	D2	340
	Height incl. fastening clips	H1	382.5
	Height incl. EMC shroud	H2	540
EMC shroud incl. shield connection terminal	Width	W2	147
	Depth	D3	approx. 174
Fastening holes	Vertical distance	A	365+2
	Vertical distance to the upper edge	B	11.5
	Horizontal distance between the fastening holes of the drive controller	C	150+0.2/-0.2
	Horizontal distance to the side edge of the drive controller	E	20

Tab. 35: SD6 dimensions, size 3 [mm]

## 7.1.5 Weight

Size	Weight without packaging [g]	Weight with packaging [g]
Size 0	2530	3520
Size 1	3700	5470
Size 2	5050	6490
Size 3	13300	14800

Tab. 36: SD6 weight [g]

If you intend to order the drive controller with accessory parts, the weight increases as follows.

Accessories	Weight without packaging [g]
Communication module	50
Terminal module	135
Safety module	110

Tab. 37: Weight of the accessory part [g]

Weight specifications for other optional accessories can be found in the appendix (see [Weights \[► 424\]](#)).

## 7.1.6 Cycle times

Possible cycle times can be found in the following table.

Type	Cycle times	Relevant parameters
Application	1 ms, 2 ms, 4 ms, 8 ms	Adjustable in A150
EtherCAT fieldbus, cyclical communication	1 ms, 2 ms, 4 ms, 8 ms	Adjustable in A150
PROFINET RT fieldbus, cyclical communication	1 ms, 2 ms, 4 ms, 8 ms	Adjustable in A150
Motion core (movement calculation)	250 µs	—
Control cascade	62.5 µs, 125 µs	Depending on B24

Tab. 38: Cycle times

## 7.2 DC link connection

The following chapter includes information on the design, dimensions and weight of the DL6A Quick DC-Link modules.

### 7.2.1 General technical data

The following information applies to all Quick DC-Link modules and corresponds to the general technical data for the base device.

Device features	
Protection class of the device	IP20 (if built over with drive controller or supply module)
Protection class	Protection class I in accordance with EN 61140 (if built over with drive controller or supply module)
Protection class of the installation space	At least IP54

Tab. 39: Device features



Transport and storage conditions	
Storage/ transport temperature	-20 °C to +70 °C Maximum change: 20 K/h
Relative humidity	Maximum relative humidity 85%, non-condensing
Vibration (transport) in accordance with EN 60068-2-6	5 Hz ≤ f ≤ 9 Hz: 3.5 mm 9 Hz ≤ f ≤ 200 Hz: 10 m/s <sup>2</sup> 200 Hz ≤ f ≤ 500 Hz: 15 m/s <sup>2</sup>
Fall height for freefall <sup>8</sup> Weight < 100 kg in accordance with EN 61800-2 (or IEC 60721-3-2, class 2M1)	0.25 m

Tab. 40: Transport and storage conditions

Operating conditions	
Surrounding temperature during operation	0 °C to 45 °C with nominal data 45 °C to 55 °C with derating -2.5% / K
Relative humidity	Maximum relative humidity 85%, non-condensing
Installation altitude	0 m to 1000 m above sea level without restrictions 1000 m to 2000 m above sea level with -1.5%/100 m derating
Pollution degree	Pollution degree 2 in accordance with EN 50178
Vibration (operation) in accordance with EN 60068-2-6	5 Hz ≤ f ≤ 9 Hz: 0.35 mm 9 Hz ≤ f ≤ 200 Hz: 1 m/s <sup>2</sup>

Tab. 41: Operating conditions

## 7.2.2 DL6A – SD6 assignment

DL6A is available in the following designs, appropriate for the sizes of the drive controller:

Type	DL6A0	DL6A1	DL6A2	DL6A3
ID No.	56440	56441	56442	56443
SD6A02	X	—	—	—
SD6A04	X	—	—	—
SD6A06	X	—	—	—
SD6A14	—	X	—	—
SD6A16	—	X	—	—
SD6A24	—	—	X	—
SD6A26	—	—	X	—
SD6A34	—	—	—	X
SD6A36	—	—	—	X
SD6A38	—	—	—	X

Tab. 42: Assignment of DL6A to SD6

<sup>8</sup> Only valid for components in original packaging

### 7.2.3 Dimensions

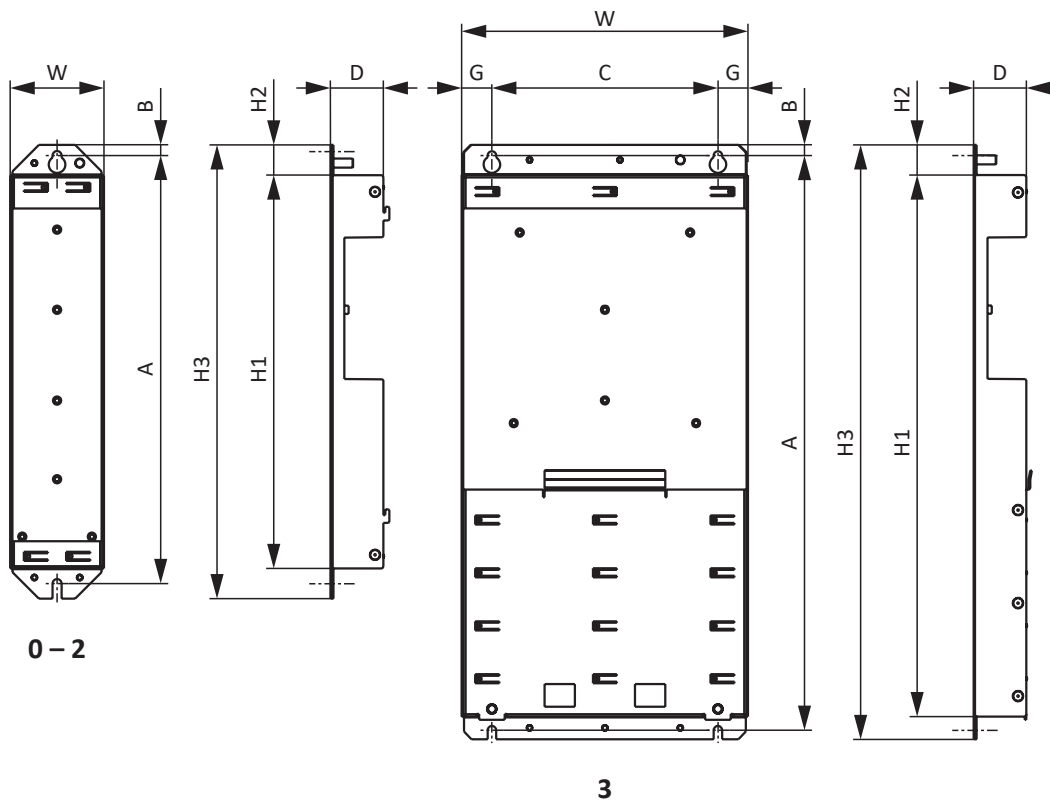

Fig. 7: DL6A dimensional drawing

Dimension			DL6A0 DL6A1	DL6A2	DL6A3
Quick DC-Link	Width	W	62	97	105
	Depth	D	35		
	Height	H1	260		358
	Fastening clip height	H2	20		15
	Height incl. fastening clips	H3	300		393
Fastening holes	Vertical distance (wall mounting)	A	283+2		380+2
	Vertical distance to the upper edge	B	7		
	Horizontal spacing of the fastening holes	C	—		150
	Horizontal distance to the side edge	G	—		20

Tab. 43: DL6A dimensions [mm]

## 7.2.4 Weight

Type	Weight without packaging [g]	Weight with packaging [g]
DL6A0	400	500
DL6A1	390	460
DL6A2	540	620
DL6A3	1540	1580

Tab. 44: DL6A weight [g]

## 7.3 Safety technology

### 7.3.1 ST6 safety module

The ST6 safety module adds the STO safety function to the SD6 drive controller via terminal X12.

#### Information

If you would like to use the STO safety function via terminals, be sure to read the manual for the ST6 safety module (see [Detailed information \[► 476\]](#)).

If you do not want to use the safety function, connect  $24 V_{DC}$  at  $STO_a$  and  $STO_b$ , e.g. using a connection with terminal X11.

Specification	Electrical data
$STO_a$	$U_{1max} = 30 V_{DC}$ (PELV) High level = $15 - 30 V_{DC}$ Low level = $0 - 8 V_{DC}$ $I_{1max} = 100 \text{ mA}$ $I_{1N} = 10 - 15 \text{ mA per channel}$ $C_{1max} = 100 \text{ nF}$
$STO_b$	
$STO_{status}$	$U_2 = U_1 - (200 \text{ m}\Omega * I_1)$
$STO_{status}$ supply	$U_1 = +24 V_{DC}, +20\%/25\%$ $I_{1max} = 100 \text{ mA}$
GND	—

Tab. 45: X12 electrical data

## 7.3.2 SE6 safety module

The SE6 safety module adds the expanded safety functions to the SD6 drive controller using terminals X14 and X15.

### Information

If you would like to use the expanded safety functionality via terminals, be sure to read the manual for the SE6 safety module (see [Detailed information \[▶ 476\]](#)).

Electrical data	Digital input	Value
Low level	I0–I7	$-3 - +5 V_{DC}$
High level		$15 - 30 V_{DC}$
$U_{1max}$		$30 V_{DC}$
$I_{1max}$		10.8 mA
$f_{1max}$		< 250 Hz; results from the SE6 cycle time and the configurable filter time constant of the input

Tab. 46: X14 electrical data – Digital inputs (SE6 option)

Electrical data	Digital output	Value
$I_{2max}$	O0 – O4	0.5 A
Typical voltage drop		25 mV
$U_1$	24 $V_{DC}$ supply	$20.4 - 28.8 V_{DC}$

Tab. 47: X15 electrical data – Digital outputs (SE6 option)

## 7.4 Operating motors

The drive controller supports rotational motors with a number of motor poles from 2 to 120 poles (1 through 60 pole pairs), as well as linear motors with pole pitches from 1 to 500 mm.

When selecting the motor, consider the technical data of the drive controller (output voltage range and clock frequency).

You can operate the following motors with the specified control modes.

Motor type	B20 Control mode	Encoders	Other settings	Characteristics
Synchronous servo motor, torque motor	64: SSM - vector control	Absolute encoder required: EnDat 2.1/2.2 digital, SSI, resolver or EnDat 2.1 Sin/Cos encoders	Without field weakening (B91 Field weakening = 0: Inactive)	High dynamics, high speed accuracy, very constant speed, high overcurrent protection
			With field weakening (B91 Field weakening = 1: Active)	High dynamics, high speed accuracy, very constant speed, high overcurrent protection, greater speed range, but also higher current requirement
	48: SSM-vector control incremental encoder	Incremental encoder or relative sin/cos encoder required	Without field weakening (B91 Field weakening = 0: Inactive)	High dynamics, high speed accuracy, very constant speed, high overcurrent protection
			With field weakening (B91 Field weakening = 1: Active)	High dynamics, high speed accuracy, very constant speed, high overcurrent protection, greater speed range, but also higher current requirement
Synchronous linear motor	70: SLM - vector control	Linear encoder and commutation information required	—	High dynamics, high overcurrent protection
Asynchronous motor	2: ASM - vector control	Encoder required	—	High dynamics, high speed accuracy, very constant speed, high overcurrent protection
	3: ASM - sensorless vector control	No encoder required	—	Dynamics, speed accuracy, constant speed, overcurrent protection
	1: ASM - V/f-slip compensated		Linear characteristic curve (B21 V/f-characteristic = 0: Linear)	Very constant speed
	0: ASM - V/f-control	Quadratic characteristic curve (B21 V/f-characteristic = 1: Square)	Very constant speed, especially suitable for fan applications	
		Linear characteristic curve (B21 V/f-characteristic = 0: Linear)	Very constant speed	
		Quadratic characteristic curve (B21 V/f-characteristic = 1: Square)	Very constant speed, especially suitable for fan applications	

Tab. 48: Motor types and control modes

## 7.5 Evaluable encoders

The technical data of the evaluable encoder can be found in the following chapters.

### 7.5.1 Overview

The following table explains which connections are available for the various encoders.

If simulation is also possible at the interface in addition to evaluation, this is noted in the Note column accordingly.

Encoder	Connection	Connection location	Note
EnDat 2.1 digital	X4	Base unit	Not suitable for linear encoders
	X140	RI6 terminal module	
EnDat 2.2 digital	X4	Base unit	The drive controller evaluates the information reported by the encoder and automatically detects whether the encoder of a rotational or linear motor is connected
	X140	RI6 terminal module	
SSI	X4	Base unit	—
	X50	SE6 safety module	Plausibility encoder
	X120	XI6 or RI6 terminal modules	Evaluation and simulation
Incremental HTL	X4	Base unit	HTL signals, differential
	X101	IO6, XI6 or RI6 terminal modules	HTL signals, single-ended; evaluation and simulation
Incremental TTL	X4	Base unit	TTL differential signals; the LA6 adapter box is required for connection of TTL linear encoders with single-ended TTL Hall sensor
	X50	SE6 safety module	TTL differential signals; plausibility encoder
	X101	RI6 terminal module	TTL signals, single-ended
	X120	XI6 or RI6 terminal modules	TTL signals, differential; evaluation and simulation
HTL pulse and direction	X101	IO6, XI6 or RI6 terminal modules	HTL signals, single-ended; evaluation and simulation
TTL pulse and direction	X101	RI6 terminal module	TTL signals, single-ended
	X120	XI6 or RI6 terminal modules	TTL signals, differential; evaluation and simulation
Resolver	X140	RI6 terminal module	—
EnDat 2.1 sin/cos	X140	RI6 terminal module	—
Sin/cos	X140	RI6 terminal module	Sin/cos encoders with W&S are connected to X140 directly; RI6 evaluates the analog sin/cos signals
Hall sensor	X101	IO6, XI6 or RI6 terminal modules	For connecting single-ended HTL Hall sensors directly; Hall sensors with single-ended TTL signal levels can be connected using the LA6 adapter box; LA6 converts the signals from the Hall sensors for X101 accordingly
	X120	XI6 or RI6 terminal modules	For connecting TTL differential Hall sensors directly; Hall sensors with TTL single-ended signal levels can be connected using the LA6 adapter box; LA6 converts the signals from the Hall sensors for X120 accordingly

Tab. 49: Encoder connections

## 7.5.2 Signal transmission

You can find the signal levels valid for the signal transmission in the following chapters.

### 7.5.2.1 Encoder inputs

The following signal levels apply to the encoder inputs for single-ended signal transmission:

Signal level	HTL, single-ended	TTL, single-ended
Low level	0 to $8 V_{DC}$	0 to $0.8 V_{DC}$
High level	15 to $30 V_{DC}$	2 to $6 V_{DC}$

The following signal levels apply to the encoder inputs for differential signal transmission:

Signal level	Differential HTL	TTL, differential (ANSI TIA/EIA-422)	Differential TTL to X50 (SE6 option)
Low level	$-30$ to $-4.2 V_{DC}$	$-6$ to $-0.2 V_{DC}$	$\leq 0.5 V_{DC}$
High level	$4.2$ to $30 V_{DC}$	$0.2$ to $6 V_{DC}$	$\geq 2.5 V_{DC}$

### 7.5.2.2 Encoder outputs

The following signal levels apply to single-ended signal transmission at encoder outputs:

Signal level	HTL, single-ended
Low level	$0 V_{DC}$
High level	$U_1 - 2 V_{DC}$

Tab. 50: Signal level of encoder outputs, single-ended

The following signal levels apply to differential signal transmission at encoder outputs:

Signal level	TTL, differential
Low level	$-3 V_{DC}$
High level	$3 V_{DC}$

Tab. 51: Signal levels of encoder outputs, differential

## 7.5.3 Drive controllers

The X4 connection is provided on the bottom of the drive controller as an encoder interface.

### 7.5.3.1 X4

#### EnDat 2.1 digital encoders

Specification	EnDat 2.1 digital
$U_2$	5 – 15 V <sub>DC</sub> (see encoder supply)
$I_{2max}$	250 mA (sum of X4, X120, X140: 500 mA)
$I_{2min}$	13 mA
Encoder type	Single-turn and multi-turn; not suitable for linear encoders
Clock frequency	2 MHz
Max. cable length	100 m, shielded

Tab. 52: EnDat 2.1 digital specification

#### EnDat 2.2 digital encoders

Specification	EnDat 2.2 digital
$U_2$	5 – 15 V <sub>DC</sub> (see encoder supply)
$I_{2max}$	250 mA (sum of X4, X120, X140: 500 mA)
$I_{2min}$	13 mA
Encoder type	Single-turn and multi-turn
Clock frequency	4 MHz
Max. cable length	100 m, shielded

Tab. 53: EnDat 2.2 digital specification

#### SSI encoder (free setting)

Obey the instructions on how to freely set SSI encoders (see [SSI encoder at X4 with free setting \(H00 = 78\)](#) [► 470]).

Specification	SSI
$U_2$	5 – 15 V <sub>DC</sub> (see encoder supply)
$I_{2max}$	250 mA (sum of X4, X120, X140: 500 mA)
$I_{2min}$	13 mA
Encoder type	Single-turn and multi-turn
Data length	Various resolutions possible
Clock frequency	150 – 1000 kHz
Sampling rate	250 µs
Monoflop time	10 – 100 µs
Code	Binary or gray
Transfer	Double or single
Max. cable length	100 m, shielded

Tab. 54: SSI specification (free setting)



## SSI encoders

Obey the instructions on how to set SSI encoders (see [SSI encoder at X4 \(H00 = 65\) \[► 471\]](#)).

Specification	SSI
$U_2$	5 – 15 V <sub>DC</sub> (see encoder supply)
$I_{2max}$	250 mA (sum of X4, X120, X140: 500 mA)
$I_{2min}$	13 mA
Encoder type	Single-turn and multi-turn
Data length	13, 24 or 25 bits
Clock frequency	250 or 600 kHz
Sampling rate	250 µs
Monoflop time	30 µs
Code	Binary or gray
Transfer	Double or single
Max. cable length	100 m, shielded

Tab. 55: SSI specification

## Incremental encoders

Specification	Incremental signals
$U_2$	5 – 15 V <sub>DC</sub> (see encoder supply)
$I_{2max}$	250 mA (sum of X4, X120, X140: 500 mA)
$I_{2min}$	13 mA
$f_{max}$	1 MHz
Signal level	Differential HTL and differential TTL
Max. cable length	100 m, shielded

Tab. 56: Specification for incremental signals

### Information

#### Calculation example – Maximum frequency $f_{max}$

for an encoder with 2,048 pulses per revolution: 3,000 revolutions per minute (equivalent to 50 revolutions per second) \*  
 2,048 pulses per revolution = 102,400 pulses per second = 102.4 kHz << 1 MHz

**Encoder supply**

$U_2$	Through	Note
5 V <sub>DC</sub> +/-10% at encoder	Sense line of the encoder connected at pin 12 (U <sub>2</sub> Sense)	STOBER synchronous servo motors; EnDat 2.1/2.2 encoder (standard)
5 V <sub>DC</sub> +/-10%	Pin 12 (U <sub>2</sub> Sense) bridged with pin 4 (U <sub>2</sub> )	STOBER asynchronous motors; TTL incremental encoders (for customer-specific solutions), without cable compensation
11 V <sub>DC</sub> +/-15%	Pin 12 (U <sub>2</sub> Sense) not assigned	—
15 V <sub>DC</sub> +/-10%	Pin 12 (U <sub>2</sub> Sense) bridged with pin 2 (0 V GND)	STOBER asynchronous motors; HTL incremental encoders: bridge in cable connector connected to X4; SSI encoders: bridge for U2 made on the motor side

Tab. 57: Encoder supply X4

**7.5.3.2 X50 (SE6 option)****SSI encoders**

Specification	SSI
$U_2$	5 – 30 V <sub>DC</sub>
$I_{2max}$	0.2 A
$I_{2min}$	—
Encoder type	Single-turn and multi-turn
Data length	12 – 28 bits
Clock frequency	300 kHz
Sampling rate	3 ms
Monoflop time	≤ 30 μs
Code	Binary or gray
Transfer	Single
Max. cable length	50 m, shielded

Tab. 58: SSI specification

**Incremental encoders**

Specification	Incremental signals
$U_2$	5 – 30 V <sub>DC</sub>
$I_{2max}$	0.2 A
$I_{2min}$	—
$f_{max}$	500 kHz
Signal level	TTL, differential
Max. cable length	50 m, shielded

Tab. 59: Specification for incremental signals

## 7.5.4 Terminal module

Depending on the terminal module, the following additional encoder interfaces are available.

### 7.5.4.1 X101 for encoders

The X101 connection is a part of the optional XI6, RI6 or IO6 terminal modules.

#### Information

To evaluate single-ended TTL signals at the X101 connection, you need the RI6 terminal module. Using three sliders, select the input voltage range (HTL or TTL) for the inputs DI3 to DI5. Observe the information printed on the terminal module for the correct position of the switches.

Use the digital inputs DI3 to DI5 to evaluate incremental or pulse/direction signals. For the simulation, use the digital outputs DO1 and DO2.

Hall sensors with single-ended HTL signal levels can be connected to digital inputs DI1 through DI3 directly.

#### General specification

Feature	All sizes
Max. cable length	30 m

Tab. 60: Cable length [m]

#### X101 on RI6 terminal module

Electrical data	Digital inputs/ outputs	HTL, single-ended (evaluation and simulation)	TTL, single-ended
$U_{1max}$	DI1 – DI5	30 V <sub>DC</sub>	6 V <sub>DC</sub>
$I_{1max}$		16 mA	13 mA
$f_{max}$	DI1 – DI3	10 kHz	10 kHz
$f_{max}$	DI4 – DI5	100 kHz (if high level > 15 V <sub>DC</sub> and external push-pull wiring)	250 kHz
$I_{2max}$	DO1 – DO2 as encoder output	100 mA	—
Typical voltage drop		< 2 V <sub>DC</sub>	—
$f_{max}$		250 kHz	—
$U_1$	24 V supply	18 – 28.8 V <sub>DC</sub>	—

Tab. 61: Specification for X101 on RI6 terminal module for incremental, pulse/direction or hall sensor signals

#### Information

##### Calculation example – Maximum frequency $f_{max}$

for an encoder with 2,048 pulses per revolution: 3,000 revolutions per minute (equivalent to 50 revolutions per second) \*  
 2,048 pulses per revolution = 102,400 pulses per second = 102.4 kHz < 250 kHz

**X101 on XI6 terminal module**

Electrical data	Digital inputs/ outputs	HTL, single-ended (evaluation and simulation)
$U_{1max}$	DI1 – DI5	30 V <sub>DC</sub>
$I_{1max}$		16 mA
$f_{max}$	DI1 – DI3	10 kHz
$f_{max}$	DI4 – DI5	100 kHz (if high level > 15 V <sub>DC</sub> and external push-pull wiring)
$I_{2max}$	DO1 – DO2 as encoder output	50 mA
Typical voltage drop		< 2 V <sub>DC</sub>
$f_{max}$		250 kHz
$U_1$	24 V supply	18 – 28.8 V <sub>DC</sub>

Tab. 62: Specification for X101 on XI6 terminal module for incremental, pulse/direction or hall sensor signals

<b>Information</b>
--------------------

**Calculation example – Maximum frequency  $f_{max}$**   
 for an encoder with 2,048 pulses per revolution: 3,000 revolutions per minute (equivalent to 50 revolutions per second) \*  
 2,048 pulses per revolution = 102,400 pulses per second = 102.4 kHz < 250 kHz

**X101 on IO6 terminal module**

Electrical data	Digital inputs/ outputs	HTL, single-ended (evaluation and simulation)
$U_{1max}$	DI1 – DI5	30 V <sub>DC</sub>
$I_{1max}$		16 mA
$f_{max}$	DI1 – DI3	10 kHz
$f_{max}$	DI4 – DI5	100 kHz (if high level > 15 V <sub>DC</sub> and external push-pull wiring)
$I_{2max}$	DO1 – DO2 as encoder output	100 mA
Typical voltage drop		< 2 V <sub>DC</sub>
$f_{max}$		250 kHz
$U_1$	24 V supply	18 – 28.8 V <sub>DC</sub>

Tab. 63: Specification for X101 on IO6 terminal module for incremental, pulse/direction or hall sensor signals

<b>Information</b>
--------------------

**Calculation example – Maximum frequency  $f_{max}$**   
 for an encoder with 2,048 pulses per revolution: 3,000 revolutions per minute (equivalent to 50 revolutions per second) \*  
 2,048 pulses per revolution = 102,400 pulses per second = 102.4 kHz < 250 kHz

### 7.5.4.2 X120

The X120 encoder connection is part of the optional XI6 and RI6 terminal modules.

#### SSI encoder (free setting, evaluation and simulation)

Obey the instructions on the free setting of SSI encoders for the XI6 terminal module from hardware version 14 or RI6 terminal module from hardware version 8 (see [SSI encoder at X120 with free setting \(H120 = 76 or 83\)](#) [► 473]).

Specification	SSI
$U_2$	15 V <sub>DC</sub> +/- 10% (see encoder supply)
$I_{2max}$	250 mA (sum of X4, X120, X140: 500 mA)
Encoder type	Single-turn and multi-turn
Data length	Various resolutions possible
Clock frequency	150 – 1000 kHz
Sampling rate	250 µs
Monoflop time	10 – 100 µs
Code	Binary or gray
Transfer	Double or single
Max. cable length	50 m, shielded

Tab. 64: SSI specification (free setting, evaluation and simulation)

#### SSI encoder (evaluation and simulation)

Obey the instructions on how to set SSI encoders (see [SSI encoder at X120 \(H120 = 67\)](#) [► 474]).

Specification	SSI
$U_2$	15 V <sub>DC</sub> +/- 10% (see encoder supply)
$I_{2max}$	250 mA (sum of X4, X120, X140: 500 mA)
Encoder type	Single-turn and multi-turn
Data length	13, 24 or 25 bits
Clock frequency	600 kHz (motor encoder); 250 kHz (position encoder)
Sampling rate	250 µs
Monoflop time	30 µs
Code	Binary or gray
Transfer	Double or single
Max. cable length	50 m, shielded

Tab. 65: SSI specification (evaluation and simulation)

**Incremental encoder (evaluation and simulation), pulse/direction interface (evaluation and simulation) or Hall sensor**

Specification	Incremental, pulse/direction or hall sensors
$U_2$	15 V <sub>DC</sub> +/- 10% (see encoder supply)
$I_{2max}$	250 mA (sum of X4, X120, X140: 500 mA)
$f_{max}$	Evaluation: 1 MHz; simulation: 500 kHz
Signal level	TTL, differential
Max. cable length	50 m, shielded

Tab. 66: Specification for differential TTL incremental, pulse/direction or hall sensor signals

<b>Information</b>
--------------------

**Calculation example – Maximum frequency  $f_{max}$**

for an encoder with 2,048 pulses per revolution: 3,000 revolutions per minute (equivalent to 50 revolutions per second) \*  
 2,048 pulses per revolution = 102,400 pulses per second = 102.4 kHz

**Encoder supply**

Depending on the power consumption of the encoder, an external supply may be required, which can cause differences in the GND connection.

$U_2$	Bridge
Internal: Pin 8 ( $U_2$ )	Pin 1 (GND Enc) to pin 9 (0 V GND)
External	Pin 1 (GND Enc) to 0 V GND of the external supply

Tab. 67: X120 encoder supply

**7.5.4.3 X140**

The X140 encoder connection is a part of the optional RI6 terminal module.

**EnDat 2.1 digital encoders**

Specification	EnDat 2.1 digital
$U_2$	5 – 12 V <sub>DC</sub> (see encoder supply)
$I_{2max}$	250 mA (sum of X4, X120, X140: 500 mA)
$I_{2min}$	13 mA
Encoder type	Single-turn and multi-turn; not suitable for linear encoders
Clock frequency	2 MHz
Max. cable length	100 m, shielded

Tab. 68: EnDat 2.1 digital specification

### EnDat 2.2 digital encoders

Specification	EnDat 2.2 digital
$U_2$	5 – 12 V <sub>DC</sub> (see encoder supply)
$I_{2max}$	250 mA (sum of X4, X120, X140: 500 mA)
$I_{2min}$	13 mA
Encoder type	Single-turn and multi-turn
Clock frequency	4 MHz
Max. cable length	100 m, shielded

Tab. 69: EnDat 2.2 digital specification

### Resolver

Specification	Resolver signals
Measuring range	± 2.5 V
Resolution	16 bits
$U_2$	± 10 V
$I_{2max}$	80 mA
$f_2$	7 – 9 kHz
$P_{max}$	0.8 W
Transfer ratio	0.5 ± 5%
Number of poles	2, 4, 6 and 8
Signal shape	Sine
Max. cable length	100 m, shielded

Tab. 70: Specification for resolver signals

### EnDat 2.1 sin/cos encoder and sin/cos encoder

Specification	EnDat 2.1 sin/cos, sin/cos
Measuring range	± 2.5 V <sub>DC</sub>
Resolution	16 bits
$U_2$	5 – 12 V <sub>DC</sub> (see encoder supply)
$I_{2max}$	250 mA (sum of X4, X120, X140: 500 mA)
$I_{2min}$	13 mA
Encoder type	Single-turn and multi-turn
$f_{max}$ analog	225 kHz
$f_{max}$ digital	2 MHz
Max. cable length	100 m, shielded

Tab. 71: EnDat 2.1 sin/cos, sin/cos specification

<b>Information</b>
--------------------

**Calculation example – Maximum frequency  $f_{max}$** 

for an encoder with 2,048 pulses per revolution: 3,000 revolutions per minute (equivalent to 50 revolutions per second) \*  
 2,048 pulses per revolution = 102,400 pulses per second = 102.4 kHz

**Encoder supply**

$U_2$	Through	Note
5 V <sub>DC</sub> +/- 10% at encoder	Sense line of the encoder connected at pin 12 (U <sub>2</sub> Sense)	STOBER synchronous servo motors; EnDat 2.1/2.2 (standard)
5 V <sub>DC</sub> +/- 10%	Pin 12 (U <sub>2</sub> Sense) bridged with pin 4 (U <sub>2</sub> )	STOBER asynchronous motors; TTL incremental encoders (for customer-specific solutions), without cable compensation
11 V <sub>DC</sub> +/- 10%		Pin 12 (U <sub>2</sub> Sense) not assigned
12 V <sub>DC</sub> +/- 10%	Pin 12 (U <sub>2</sub> Sense) bridged with pin 2 (0 V GND)	

Tab. 72: Encoder supply X140



## 7.5.5 Encoder adapter box

The connections X300 to X306 are part of the optional LA6 adapter box. LA6 is an interface adapter for differential TTL incremental signals and single-ended TTL Hall sensor signals. LA6 transmits TTL signals from synchronous linear motors to the SD6 drive controller.

### 7.5.5.1 X300

X300 transmits differential TTL incremental signals to connection X4 of the drive controller.

#### Differential TTL incremental encoders

Specification	Incremental signals
$U_2^9$	5 V <sub>DC</sub>
$I_{2max}$	250 mA
$I_{2min}$	13 mA
$f_{max}$	1 MHz
Signal level	TTL, differential
Max. cable length	100 m, shielded

Tab. 73: Specification for TTL differential incremental signals

### 7.5.5.2 X301

X301 converts single-ended TTL Hall sensor signals for the transmission to connection X120 on the XI6 or RI6 terminal module.

#### Differential TTL Hall sensor

Specification	Hall sensor signals
$U_2^{10}$	15 V <sub>DC</sub>
$I_{2max}$	250 mA
$f_{max}$	1 MHz
Signal level	TTL, differential
Max. cable length	50 m, shielded

Tab. 74: Differential TTL Hall sensor signals specification

<sup>9</sup> The drive controller passes the output voltage to the encoder.

<sup>10</sup> The drive controller passes the output voltage to the encoder.

### 7.5.5.3 X302

X302 converts single-ended TTL Hall sensor signals for the transmission to connection X101 on the XI6, RI6 or IO6 terminal module.

#### Single-ended HTL Hall sensor

Specification	Incremental signals
Typical voltage drop	$< 2 V_{DC}$ ; related to the encoder supply $U_2$ of terminal X303
$I_{2max}$	50 mA
Signal level	HTL, single-ended
Max. cable length	30 m

Tab. 75: Single-ended HTL Hall sensor signals specification

### 7.5.5.4 X303

The connection of  $24 V_{DC}$  to X303 is required for supplying the adapter box.

Electrical data	Value
$U_1$	$24 V_{DC} +20\%/-15\%$
$I_{1max}$	100 mA

Tab. 76: Electrical data

Feature	All sizes
Max. cable length	30 m

Tab. 77: Cable length [m]

### 7.5.5.5 X304, X305, X306

Connect the differential TTL incremental encoder to the single-ended TTL Hall sensor at X304 using a D-sub connector.

At X305 and X306, you can alternatively connect the differential TTL incremental encoder with the single-ended TTL Hall sensor using loose cable ends.

#### Differential TTL incremental encoders with single-ended TTL Hall sensor

Specification	Hall sensor signals
$U_2$	$5 V_{DC}$
$I_{2max}$	250 mA
$I_{2min}$	13 mA
$f_{max}$	1 MHz
Signal level	Differential TTL (incremental encoder), single-ended TTL (hall sensor)
Max. cable length	100 m, shielded

Tab. 78: Differential TTL incremental signals with single-ended TTL Hall sensor signals specification

<b>Information</b>
--------------------

**Calculation example – Maximum frequency  $f_{max}$**   
 for an encoder with 2,048 pulses per revolution: 3,000 revolutions per minute (equivalent to 50 revolutions per second) \*  
 2,048 pulses per revolution = 102,400 pulses per second = 102.4 kHz  $\ll$  1 MHz

## 7.6 Terminal module

The technical data of the optional terminal modules can be found in the following chapters.

### 7.6.1 XI6

#### General specification

Specification	Value
Internal device update rate	Cycle time for the application parameterized in A150; $t_{\min} = 1 \text{ ms}$ ; also applicable to digital inputs DI4 and DI5: with timestamp correction in an accuracy range of $1 \mu\text{s}$
Max. cable length	30 m

Tab. 79: General specification

#### X100 specification for analog signals

Electrical data	Analog input/output	Value
Measuring range	AI1 – AI2	$\pm 10 V_{\text{DC}}$
Resolution		16 bits
Internal resistance		$> 40 \text{ k}\Omega$
Level	AE1 as current input (AI1+ and AI1 shunt bridged)	$\pm 20 \text{ mA}$
Resolution		16 bits
Internal resistance		$492 \Omega$
Wire break monitoring		Can be parameterized in F15
Level	AO1 – AO2	$\pm 10 V_{\text{DC}}$
$I_{2\text{max}}$		10 mA

Tab. 80: X100 electrical data for analog signals

#### X101 specification for digital signals

Electrical data	Digital inputs/outputs	Value
Low level	DI1 – DI5	$0 - 8 V_{\text{DC}}$
High level		$12 - 30 V_{\text{DC}}$
$U_{1\text{max}}$		$30 V_{\text{DC}}$
$I_{1\text{max}}$		16 mA
$I_{2\text{max}}$	DO1 – DO2	50 mA
Typical voltage drop		$< 2 V_{\text{DC}}$
$U_1$	24 $V_{\text{DC}}$ supply	$18 - 28.8 V_{\text{DC}}$

Tab. 81: X101 electrical data for digital signals

#### X101 for encoders

If you would like to use X101 as an encoder connection, obey the technical data of the evaluable encoders at X101 (see [X101 for encoders](#) [▶ 67]).

**X102 specification**

Electrical data	Analog input	Value
Measuring range	AI3	$\pm 10 V_{DC}$
Resolution		16 bits
Internal resistance		$> 40 k\Omega$

Tab. 82: X102 electrical data

**X103A specification**

Electrical data	Digital output	Value
$I_{2max}$	DO3 – DO6	50 mA
Typical voltage drop		$< 2 V_{DC}$
Inductive load	DO3 – DO4	Max. 1.2 VA

Tab. 83: X103A electrical data

**X103B specification**

Electrical data	Digital inputs/ outputs	Value
Low level	DI6	$0 - 8 V_{DC}$
High level		$12 - 30 V_{DC}$
$U_{1max}$		$30 V_{DC}$
$I_{1max}$		16 mA
$I_{2max}$	DO7 – DO10	50 mA
Typical voltage drop		$< 2 V_{DC}$

Tab. 84: X103B electrical data

**X103C specification**

Electrical data	Digital input	Value
Low level	DI7 – DI13	$0 - 8 V_{DC}$
High level		$12 - 30 V_{DC}$
$U_{1max}$		$30 V_{DC}$
$I_{1max}$		16 mA

Tab. 85: X103C electrical data

**X120 for encoders**

X120 is available as an encoder connection. Note the technical data of the evaluable encoders at X120 (see [X120 \[► 69\]](#)).

## 7.6.2 RI6

### General specification

Specification	Value
Internal device update rate	Cycle time for the application parameterized in A150; $t_{\min} = 1 \text{ ms}$ ; also applicable to digital inputs DI4 and DI5: with timestamp correction in an accuracy range of $1 \mu\text{s}$
Max. cable length	30 m

Tab. 86: General specification

### X100 specification for analog signals

Electrical data	Analog input/ output	Value
Measuring range	AI1 – AI2	$\pm 10 V_{\text{DC}}$
Resolution		16 bits
Internal resistance		$> 40 \text{ k}\Omega$
Level	AE1 as current input (AI1+ and AI1 shunt bridged)	$\pm 20 \text{ mA}$
Resolution		16 bits
Internal resistance		$492 \Omega$
Wire break monitoring		Can be parameterized in F15
Level	AO1 – AO2 (short- circuit proof)	$\pm 10 V_{\text{DC}}, \pm 20 \text{ mA}$
$I_{2\text{max}}$		$\pm 20 \text{ mA}$

Tab. 87: X100 electrical data for analog signals

### X101 specification for digital signals

Electrical data	Digital inputs/ outputs	Value
Low level	DI1 – DI5	$0 - 8 V_{\text{DC}}$
High level		$12 - 30 V_{\text{DC}}$
$U_{1\text{max}}$		$30 V_{\text{DC}}$
$I_{1\text{max}}$		$16 \text{ mA}$
$f_{1\text{max}}$	DI1 – DI3	$10 \text{ kHz}$
$f_{1\text{max}}$	DI4 – DI5	$250 \text{ kHz}$
$I_{2\text{max}}$	DO1 – DO2	$100 \text{ mA}$
Typical voltage drop		$< 2 V_{\text{DC}}$
$U_1$	24 $V_{\text{DC}}$ supply	$18 - 28.8 V_{\text{DC}}$

Tab. 88: X101 electrical data for digital signals

### X101 for encoders

If you would like to use X101 as an encoder connection, obey the technical data of the evaluable encoders at X101 (see [X101 for encoders](#) [► 67]).

### X120 for encoders

X120 is available as an encoder connection. Note the technical data of the evaluable encoders at X120 (see [X120 \[► 69\]](#)).

### X140 for encoders

X140 is available as an encoder connection. Note the technical data of the evaluable encoders at X140 (see [X140 \[► 70\]](#)).

## 7.6.3 I06

### General specification

Specification	Value
Internal device update rate	Cycle time for the application parameterized in A150; $t_{\min} = 1 \text{ ms}$ ; also applicable to digital inputs DI4 and DI5: with timestamp correction in an accuracy range of $1 \mu\text{s}$
Max. cable length	30 m

Tab. 89: General specification

### X100 specification for analog signals

Electrical data	Analog input/output	Value
Measuring range	AI1 – AI2	$\pm 10 V_{\text{DC}}$
Resolution		12 bits
Internal resistance		$> 40 \text{ k}\Omega$
Level	AE1 as current input (AI1+ and AI1 shunt bridged)	$\pm 20 \text{ mA}$
Resolution		12 bits
Internal resistance		$492 \Omega$
Wire break monitoring		Can be parameterized in F15
Level	AO1 – AO2 (short-circuit proof)	$\pm 10 V_{\text{DC}}, \pm 20 \text{ mA}$
$I_{2\text{max}}$		$\pm 20 \text{ mA}$

Tab. 90: X100 electrical data for analog signals

### X101 specification for digital signals

Electrical data	Digital inputs/ outputs	Value
Low level	DI1 – DI5	0 – 8 V <sub>DC</sub>
High level		12 – 30 V <sub>DC</sub>
U <sub>1max</sub>		30 V <sub>DC</sub>
I <sub>1max</sub>		16 mA
f <sub>1max</sub>	DI1 – DI3	10 kHz
f <sub>1max</sub>	DI4 – DI5	250 kHz
I <sub>2max</sub>	DO1 – DO2	100 mA
Typical voltage drop		< 2 V <sub>DC</sub>
U <sub>1</sub>	24 V <sub>DC</sub> supply	18 – 28.8 V <sub>DC</sub>

Tab. 91: X101 electrical data for digital signals

### X101 for encoders

If you would like to use X101 as an encoder connection, obey the technical data of the evaluable encoders at X101 (see [X101 for encoders \[► 67\]](#)).

## 7.6.4 Weight

Accessories	Weight without packaging [g]
Terminal module	135

Tab. 92: Weight of the accessory part [g]

## 7.7 Controllable brakes

You can control the following brakes:

- 24 V<sub>DC</sub> brakes connected directly to X5
- Brakes connected indirectly over contactor to X5

Only in combination with SE6 safety module:

- 24 V<sub>DC</sub> brakes connected directly to X8
- Brakes connected indirectly over contactor to X8

### Information

Control modes 48: SSM-vector control incremental encoder and 70: SLM - vector control with commutation finding using Wake and Shake may only be used in combination with a brake for axes without gravity load.

For more information, see [B20 = 48, 64 or 70 \[► 289\]](#).

### 7.7.1 X5

Electrical data	Brake output
$I_{2max}$	3 A
$I_{2min}$ (direct brake control)	330 mA
$I_{2min}$ (indirect brake control)	20 mA
$f_{2max}$	1 Hz
$E_{2max}$	2.84 J

Tab. 93: Electrical data of the brake output

In combination with the ST6 safety module, the brake connected to X5 is supplied via terminal X6, in combination with the SE6 safety module via terminal X7.

### 7.7.2 X8 (option SE6)

Electrical data	Brake output
$I_{2max}$	3.6 A / 2.5 A at surrounding temperature > 45 °C
$I_{2min}$	0.5 mA
$f_{2max}$	1 Hz
$E_{2max}$	4.5 J

Tab. 94: Electrical data of the brake output

The brake connected to X8 is supplied over terminal X7.

## 7.8 Evaluable motor temperature sensors

You can connect a PTC triplet, KTY84-130 or Pt1000 to the SD6 drive controller.

**Information**

STOBER recommends the use of PTC thermistors as thermal winding protection.

**Information**

Evaluation of the temperature sensors is always active. If operation without a temperature sensor is permitted, the connections must be bridged to X2. Otherwise a fault is triggered when the device is switched on.

Type	Triggering limit
PTC thermistor	4000 Ω
Pt1000 temperature sensor	Can be parameterized in °C in parameter B39
Pt1000 temperature sensor	Can be parameterized in °C in parameter B39
KTY temperature sensor	Can be parameterized in °C in parameter B39

Tab. 95: Triggering limit of temperature sensor



## 7.9 Braking resistor

In addition to drive controllers, STOBER offers the following braking resistors described below in various sizes and performance classes. For the selection, note the minimum permitted braking resistors specified in the technical data of the individual drive controller types.

### 7.9.1 Tubular fixed resistor FZMU, FZZMU

Type	FZMU 400×65			FZZMU 400×65		
ID No.	49010	55445	55446	53895	55447	55448
SD6A02	X	—	—	—	—	—
SD6A04	X	—	—	—	—	—
SD6A06	X	—	—	—	—	—
SD6A14	(X)	—	—	X	—	—
SD6A16	(X)	—	—	X	—	—
SD6A24	(—)	X	—	(X)	X	—
SD6A26	(—)	X	—	(X)	X	—
SD6A34	(—)	(X)	X	(—)	(X)	X
SD6A36	(—)	(X)	X	(—)	(X)	X
SD6A38	(—)	(X)	X	(—)	(X)	X

Tab. 96: Assignment of FZMU, FZZMU braking resistor – SD6 drive controller

X	Recommended
(X)	Possible
(—)	Useful under certain conditions
—	Not possible

**Properties**

Specification	FZMU 400×65			FZZMU 400×65		
ID No.	49010	55445	55446	53895	55447	55448
Type	Tubular fixed resistor			Tubular fixed resistor		
Resistance [Ω]	100 ±10%	22 ±10%	15 ±10%	47 ±10%	22 ±10%	15 ±10%
Thermal drift	±10%			±10%		
Power [W]	600			1200		
Therm. time const. $\tau_{th}$ [s]	40			40		
Pulse power for < 1 s [kW]	18			36		
$U_{max}$ [V]	848			848		
Weight without packaging [g]	2200			4170		
Protection class	IP20			IP20		
Marks and test symbols	cURus, CE, UKCA			cURus, CE, UKCA		

Tab. 97: FZMU, FZZMU specification

**Dimensions**

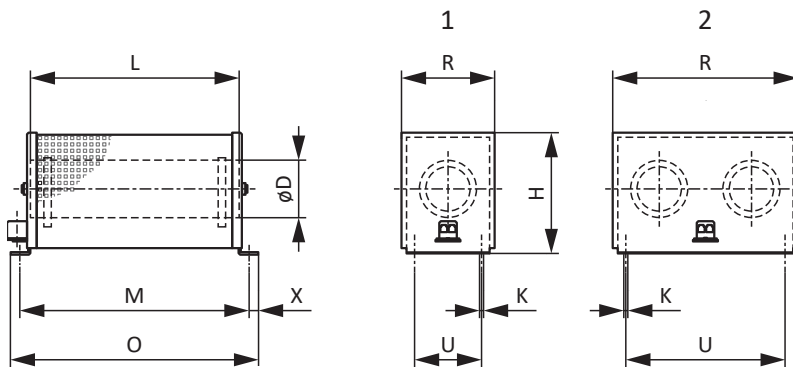

Fig. 8: FZMU (1), FZZMU (2) dimensional drawing

Dimension	FZMU 400×65			FZZMU 400×65		
ID No.	49010	55445	55446	53895	55447	55448
L x D	400 × 65			400 × 65		
H	120			120		
K	6.5 × 12			6.5 × 12		
M	430			426		
O	485			485		
R	92			185		
U	64			150		
X	10			10		

Tab. 98: FZMU, FZZMU dimensions [mm]

## 7.9.2 GVADU, GBADU flat resistor

Type	GVADU 210×20	GBADU 265×30	GBADU 405×30	GBADU 335×30	GBADU 265×30
ID No.	55441	55442	55499	55443	55444
SD6A02	X	X	X	—	—
SD6A04	X	X	X	—	—
SD6A06	X	X	X	—	—
SD6A14	(X)	(X)	(X)	X	—
SD6A16	(X)	(X)	(X)	X	—
SD6A24	(—)	(—)	(—)	(X)	X
SD6A26	(—)	(—)	(—)	(X)	X
SD6A34	(—)	(—)	(—)	(—)	(X)
SD6A36	(—)	(—)	(—)	(—)	(X)
SD6A38	(—)	(—)	(—)	(—)	(X)

Tab. 99: Assignment of GVADU, GBADU braking resistor – SD6 drive controller

X	Recommended
(X)	Possible
(—)	Useful under certain conditions
—	Not possible

### Properties

Specification	GVADU 210×20	GBADU 265×30	GBADU 405×30	GBADU 335×30	GBADU 265×30
ID No.	55441	55442	55499	55443	55444
Type	Flat resistor				
Resistance [ $\Omega$ ]	100 $\pm$ 10%	100 $\pm$ 10%	100 $\pm$ 10%	47 $\pm$ 10%	22 $\pm$ 10%
Thermal drift	$\pm$ 10%	$\pm$ 10%	$\pm$ 10%	$\pm$ 10%	$\pm$ 10%
Power [W]	150	300	500	400	300
Therm. time const. $\tau_{th}$ [s]	60	60	60	60	60
Pulse power for < 1 s [kW]	3.3	6.6	11	8.8	6.6
$U_{max}$ [V]	848	848	848	848	848
Cable design	Radox	FEP	FEP	FEP	FEP
Cable length [mm]	500	1500	500	1500	1500
Conductor cross-section [AWG]	18/19 (0.82 mm <sup>2</sup> )	14/19 (1.9 mm <sup>2</sup> )	14/19 (1.9 mm <sup>2</sup> )	14/19 (1.9 mm <sup>2</sup> )	14/19 (1.9 mm <sup>2</sup> )
Weight without packaging [g]	300	930	1410	1200	930
Protection class	IP54	IP54	IP54	IP54	IP54
Test symbols	cURus, CE, UKCA				

Tab. 100: GVADU, GBADU specification

**Dimensions**

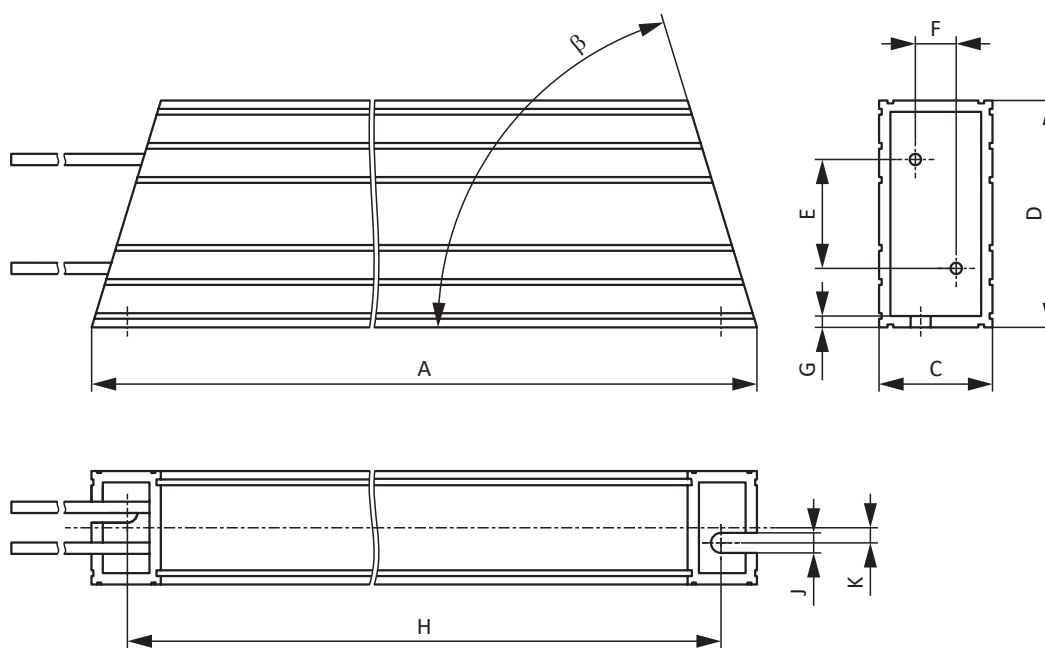

Fig. 9: GVADU, GBADU dimensional drawing

Dimension	GVADU 210×20	GBADU 265×30	GBADU 405×30	GBADU 335×30	GBADU 265×30
ID No.	55441	55442	55499	55443	55444
A	210	265	405	335	265
H	192	246	386	316	246
C	20	30	30	30	30
D	40	60	60	60	60
E	18.2	28.8	28.8	28.8	28.8
F	6.2	10.8	10.8	10.8	10.8
G	2	3	3	3	3
K	2.5	4	4	4	4
J	4.3	5.3	5.3	5.3	5.3
β	65°	73°	73°	73°	73°

Tab. 101: GVADU, GBADU dimensions [mm]

### 7.9.3 FGFKU steel-grid fixed resistor

Type	FGFKU 3100502	FGFKU 3100502	FGFKU 3111202	FGFKU 3121602
ID No.	55449	55450	55451	53897
SD6A24	X	—	—	—
SD6A26	X	—	—	—
SD6A34	(X)	X	X	X
SD6A36	(X)	X	X	X
SD6A38	(X)	X	X	X

Tab. 102: Assignment of FGFKU braking resistor – SD6 drive controller

X	Recommended
(X)	Possible
—	Not possible

#### Properties

Specification	FGFKU 3100502	FGFKU 3100502	FGFKU 3111202	FGFKU 3121602
ID No.	55449	55450	55451	53897
Type	Steel-grid fixed resistor			
Resistance [ $\Omega$ ]	22 $\pm$ 10%	15 $\pm$ 10%	15 $\pm$ 10%	15 $\pm$ 10%
Thermal drift	$\pm$ 10%	$\pm$ 10%	$\pm$ 10%	$\pm$ 10%
Power [W]	2500	2500	6000	8000
Therm. time const. $\tau_{th}$ [s]	30	30	20	20
Pulse power for < 1 s [kW]	50	50	120	160
$U_{max}$ [V]	848	848	848	848
Weight without packaging [g]	7500	7500	12000	18000
Protection class	IP20	IP20	IP20	IP20
Marks and test symbols	cURus, CE, UKCA			

Tab. 103: FGFKU specification

**Dimensions**

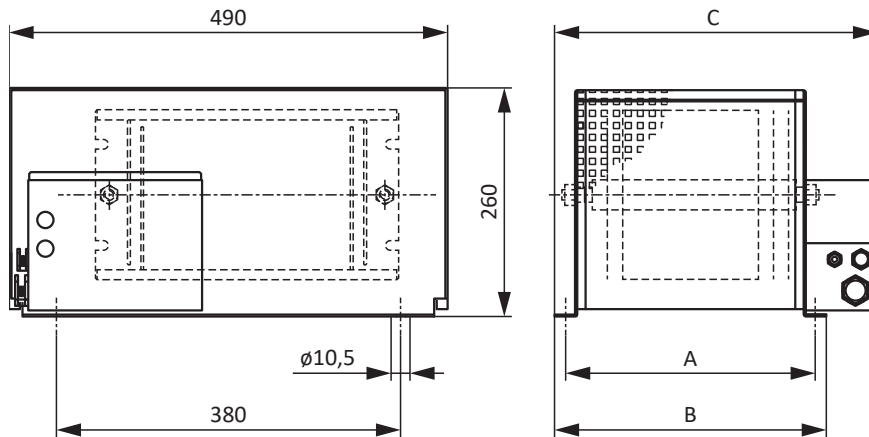

Fig. 10: FGFKU dimensional drawing

Dimension	FGFKU 3100502	FGFKU 3100502	FGFKU 3111202	FGFKU 3121602
ID No.	55449	55450	55451	53897
A	270	270	370	570
B	295	295	395	595
C	355	355	455	655

Tab. 104: FGFKU dimensions [mm]

**7.9.4 Rear section braking resistor RB 5000**

Type	RB 5022	RB 5047	RB 5100
ID No.	45618	44966	44965
SD6A02	—	—	X
SD6A04	—	—	X
SD6A06	—	—	X
SD6A14	—	X	(X)
SD6A16	—	X	(X)
SD6A24	X	—	—
SD6A26	X	—	—
SD6A34	—	—	—
SD6A36	—	—	—
SD6A38	—	—	—

Tab. 105: Assignment of RB 5000 braking resistor – SD6 drive controller

- X Recommended
- (X) Possible
- Not possible

## Properties

Specification	RB 5022	RB 5047	RB 5100
ID No.	45618	44966	44965
Resistance [ $\Omega$ ]	22 $\pm$ 10%	47 $\pm$ 10%	100 $\pm$ 10%
Thermal drift	$\pm$ 10%	$\pm$ 10%	$\pm$ 10%
Power [W]	100	60	60
Therm. time const. $\tau_{th}$ [s]	8	8	8
Pulse power for < 1 s [kW]	1.5	1.0	1.0
$U_{max}$ [V]	800	800	800
Weight without packaging [g]	640	460	440
Cable design	Radox	Radox	Radox
Cable length [mm]	250	250	250
Conductor cross-section [AWG]	18/19 (0.82 mm <sup>2</sup> )	18/19 (0.82 mm <sup>2</sup> )	18/19 (0.82 mm <sup>2</sup> )
Maximum torque of M5 threaded bolts [Nm]	5	5	5
Protection class	IP40	IP40	IP40
Marks and test symbols	cURus, CE, UKCA	cURus, CE, UKCA	cURus, CE, UKCA

Tab. 106: RB 5000 specification

## Dimensions

Dimension	RB 5022	RB 5047	RB 5100
ID No.	45618	44966	44965
Height	300	300	300
Width	94	62	62
Depth	18	18	18
Drilling diagram corresponds to size	Size 2	Size 1	Size 0 and Size 1

Tab. 107: RB 5000 dimensions [mm]

### Information

Note the dimensional data in the drilling diagram (see [Drive controllers](#) [► 110]) for the installation of the drive controller with rear section braking resistor.

## 7.10 Choke

Technical specifications for suitable chokes can be found in the following chapters.

### 7.10.1 TEP power choke

For each size 3 SD6 drive controller, you need one power choke. It dampens voltage and current peaks and reduces the load of the drive controller power feed-in.

#### Properties

Specification	TEP4010-2US00
ID No.	56528
Phases	3
Thermally allowed continuous current	100 A
Nominal current $I_{N,MF}$	90 A
Absolute loss $P_V$	103 W
Inductance	0.14 mH
Voltage range	3 × 400 V <sub>AC</sub> +32%/−50% 3 × 480 V <sub>AC</sub> +10%/−58%
Voltage drop $U_k$	2%
Frequency range	50/60 Hz
Protection class	IP00
Max. surrounding temperature $\vartheta_{amb,max}$	40 °C
Insulation class	B
Connection	Screw terminal
Connection type	Flexible with and without end sleeve
Max. conductor cross-section	6 – 35 mm <sup>2</sup>
Tightening torque	2.5 Nm
Insulation stripping length	17 mm
Installation	Screws
Directive	EN 61558-2-20
UL Recognized Component (CAN; USA)	Yes
Marks and test symbols	cURus, CE

Tab. 108: TEP specification



Dimensions

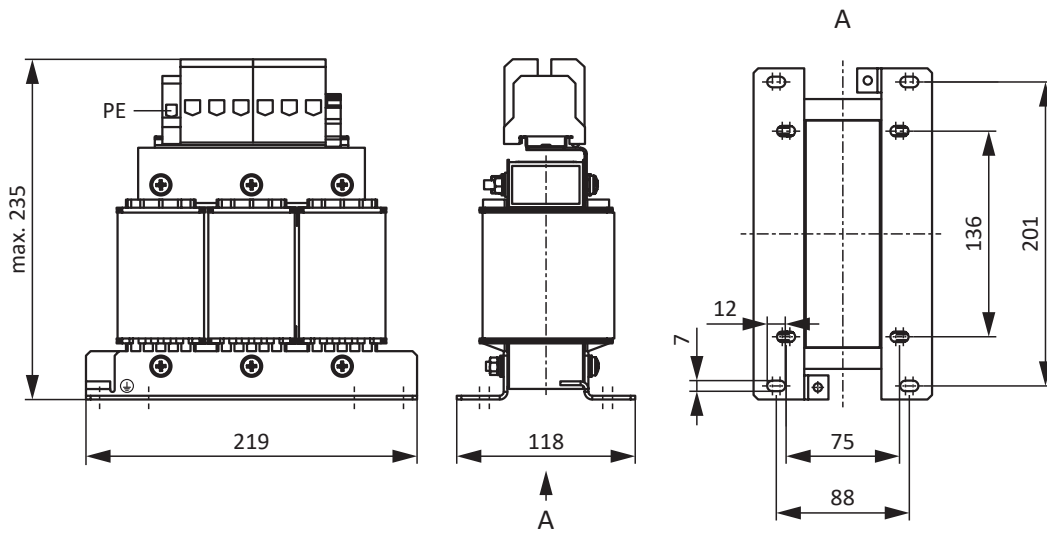

Fig. 11: Power choke dimensional drawing

Dimensions	TEP4010-2US00
Height [mm]	235
Width [mm]	219
Depth [mm]	118
Vertical distance 1 – fastening holes [mm]	201
Vertical distance 2 – Fastening holes [mm]	136
Horizontal distance 1 – fastening holes [mm]	88
Horizontal distance 2 – Fastening holes [mm]	75
Drill holes – Depth [mm]	7
Drill holes – Width [mm]	12
Screw connection – M	M6
Weight without packaging [g]	9900

Tab. 109: TEP dimensions and weight

## 7.10.2 TEP output choke

Output chokes are required for connecting size 0 to 2 drive controllers from a cable length > 50 m in order to reduce interference pulses and protect the drive system.

### Information

The following technical data only applies to a rotating magnetic field frequency of 200 Hz. For example, this rotating magnetic field frequency is achieved with a motor with 4 pole pairs and a nominal speed of 3000 rpm. Always observe the specified derating for higher rotating magnetic field frequencies. Also observe the relationship with the clock frequency.

### Properties

Specification	TEP3720-OES41	TEP3820-OCS41	TEP4020-ORS41
ID No.	53188	53189	53190
Voltage range	3 × 0 to 480 V <sub>AC</sub>		
Frequency range	0 – 200 Hz		
Nominal current I <sub>N,MF</sub> at 4 kHz	4 A	17.5 A	38 A
Nominal current I <sub>N,MF</sub> at 8 kHz	3.3 A	15.2 A	30.4 A
Max. permitted motor cable length with output choke	100 m		
Max. surrounding temperature $\vartheta_{amb,max}$	40 °C		
Protection class	IP00		
Winding losses	11 W	29 W	61 W
Iron losses	25 W	16 W	33 W
Connection	Screw terminal		
Max. conductor cross-section	10 mm <sup>2</sup>		
UL Recognized Component (CAN; USA)	Yes		
Marks and test symbols	cURus, CE		

Tab. 110: TEP specification

## Dimensions

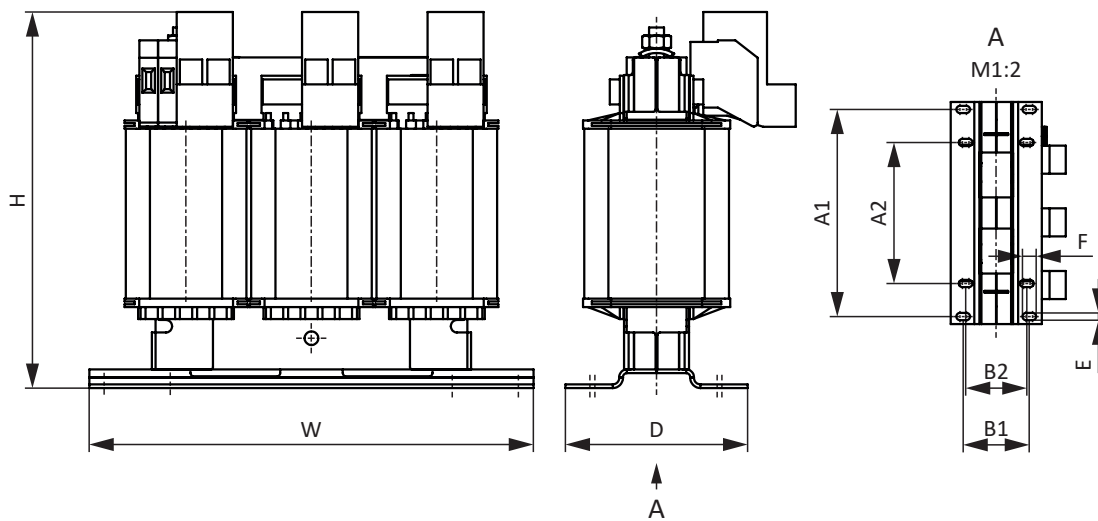

Fig. 12: TEP dimensional drawing

Dimension	TEP3720-OES41	TEP3820-OCS41	TEP4020-ORS41
Height H [mm]	Max. 153	Max. 153	Max. 180
Width W [mm]	178	178	219
Depth D [mm]	73	88	119
Vertical distance – Fastening holes A1 [mm]	166	166	201
Vertical distance – Fastening holes A2 [mm]	113	113	136
Horizontal distance – Fastening holes B1 [mm]	53	68	89
Horizontal distance – Fastening holes B2 [mm]	49	64	76
Drill holes – Depth E [mm]	5.8	5.8	7
Drill holes – Width F [mm]	11	11	13
Screw connection – M	M5	M5	M6
Weight without packaging [g]	2900	5900	8800

Tab. 111: TEP dimensions and weight

## 7.11 Encoder adapter box

This chapter contains technical specifications for the LA6 encoder adapter box.

### 7.11.1 Dimensions

Dimension	LA6
W1	70
W2	20
D1	54
D2	51
H1	129
H2	149
H3	48.8
A	140
B	4.5

Tab. 112: LA6 dimensions [mm]

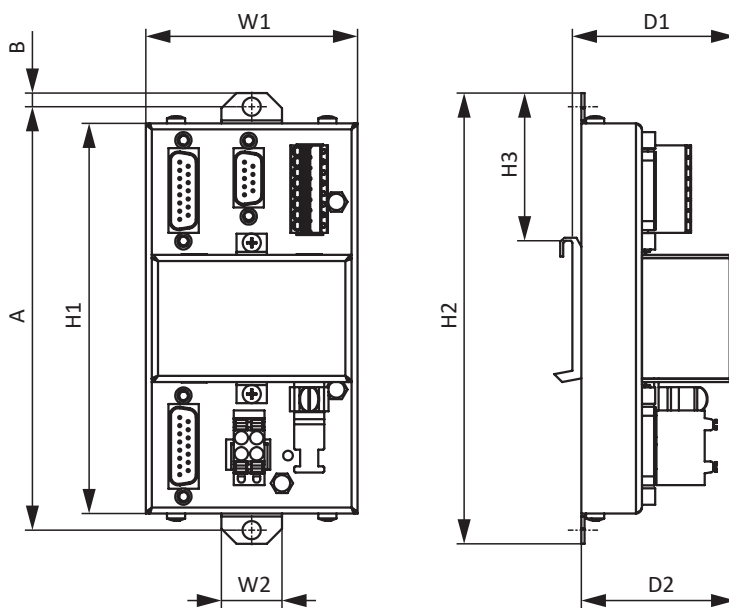

Fig. 13: LA6 dimensional drawing [mm]

### 7.11.2 Weight

Type	Weight without packaging [g]
LA6	400

Tab. 113: LA6 weight [g]

## 8 Project configuration

Relevant information on the project configuration and design of your drive system can be found in the following chapters.

### 8.1 Drive controllers

#### Minimum time between two energizing processes

The drive controllers have temperature-dependent resistors in the charging circuit that prevent the devices from being damaged when being connected to the grid after a fault, such as a short-circuited DC link, incorrect wiring, etc. These resistors are heated when charging the DC link. In order to prevent overloading, a specified, minimum time period must be maintained between energizing two devices.

---

<b>Information</b>
--------------------

For the time span between energizing two devices, note that:

- Direct, repeat activation of the supply voltage is possible for cyclical power-on/power-off operation.
- A time span of > 15 minutes must be observed between two energizing processes during continuous, cyclical power-on/power-off operation with increased charging capacity.

---

<b>Information</b>
--------------------

The STO safety function is available for safe stopping as an alternative to continuous, cyclical power-on/power-off operation.

---

### 8.2 DC link connection

Braked motors work like generators: Operating with an active drive controller, they convert kinetic energy from movement into electrical energy. This electrical energy is stored in the DC link capacitors of the drive controller. It can be supplied to powered motors with connected DC circuits and be used efficiently as a result.

However, capacitors in the DC link can only accept a limited amount of energy. The DC link voltage increases when a motor decelerates. If the DC link voltage rises above a defined limit, a chopper circuit is activated that tries to convert the excess energy into heat by means of a connected braking resistor. If the permitted maximum voltage is nonetheless reached, any possible damage must be prevented. The drive controller switches to the Fault state and shuts down.

In a DC link connection, the DC link capacitors of the drive controllers involved are connected in parallel. As a result, the maximum acceptable amount of energy increases in the DC link in comparison to a single unit.

The DC link connection can help save energy and reduce costs, especially in coil winding technology or during regular acceleration and braking cycles.

## 8.2.1 Information on design and operation

In order to connect the capacitors of multiple drive controllers, you need a separate DL6A Quick DC-Link module for each drive controller in the group.

### Information

Note that Quick DC-Link can be subject to system or country-specific standards.

### Central braking resistor

During a controlled emergency stop, all drive controllers may brake at the same time. During the design phase, check whether a central braking resistor is necessary to be able to stop certain system parts safely within a prescribed time.

### Electrical data of the drive controllers

The electrical data of the individual types of drive controllers must be observed in the design and operation of Quick DC-Link, including the following in particular:

- Self-capacitance  $C_{pU}$
- Charging capacity  $C_{N,PU}$
- Nominal input current  $I_{1N,PU}$
- Derating of the nominal input current

The values can be found in the technical data of the drive controller (see [Electrical data \[▶ 44\]](#)). For calculation examples, refer to the project configuration of the DC link connection (see [Design \[▶ 95\]](#)).

### Maximum voltage and maximum current

The maximum DC link voltage is 750 V<sub>DC</sub> and the maximum permitted overall current is 200 A.

### Group with drive controllers of size 3

Furthermore, the following framework conditions apply in a group with size 3 drive controllers:

- If a group consists of drive controllers in sizes 0, 1, 2 and 3, only those of size 3 may be connected to the grid; the remaining drive controllers may be supplied only with DC voltage
- You may connect a maximum of two drive controllers of size 3
- A TEP4010-2US00 power choke must be upstream of each size 3 drive controller connected to the grid

### Protective measures

Obey the information on the following topics:

- [Power grid supply with DC link connection \[▶ 136\]](#)
- [Line fuses for DC link connection \[▶ 138\]](#)
- [Grid connection for DC link connection \[▶ 141\]](#)

## 8.2.2 Design

### Charging capacity

The charging circuit integrated into a drive controller can charge the DC links of other drive controllers in addition to its own DC link.

#### Information

When designing the Quick DC-Link, note that the sum of the charging capacities of the drive controllers connected to the grid is greater than or equal to the sum of the self-capacitances of all drive controllers in the DC link group.

Example – Checking the charging capacity of drive controllers connected to the grid

Two SD6A26 drive controllers connected to the grid are to charge six SD6A04 drive controllers.

Calculate the charging capacity of both drive controllers connected to the grid as follows:

$$2 \times 1405 \mu\text{F} = 2810 \mu\text{F}$$

The DC link capacitance in the group to be charged corresponds to the sum of the self-capacitances of all drive controllers in the group:

$$2 \times 1000 \mu\text{F (SD6A26)} + 6 \times 135 \mu\text{F (SD6A04)} = 2810 \mu\text{F}$$

This means that it is the same as the cumulative charging capacity of both drive controllers connected to the grid. In this case, Quick DC-Link is permitted.

### Current load capacity of the input rectifiers

#### Information

When designing the Quick DC-Link, note that the required supply current does not exceed the maximum supply current in total.

$$I_{\text{minLINE}} < I_{\text{maxLINE}}$$

For calculating the effective as well as maximum supply current, SERVOSOFT is helpful mechanical and electrical design software for drive systems.

#### Calculating supply current for motors

The necessary supply current for motors can be determined using the required drive output:

$$P_{\text{LINE}} \cong P_{\text{totalMOT}}$$

#### Calculating motor rating and voltage

The following formulas and assumptions are used to calculate the motor rating and voltage:

$$P_{\text{MOT}} = \sqrt{3} \times U_{\text{MOT}} \times I_{\text{MOT}} \times \cos \varphi_{\text{MOT}}$$

$$P_{\text{Line}} = \sqrt{3} \times U_{\text{Line}} \times I_{\text{Line,nec}} \times \lambda_{\text{Line}}$$

$$U_{\text{maxMOT}} = 0,8 \times U_{\text{LINE}}$$

$$I_{\text{minLINE}} = \frac{U_{\text{MOT}}}{U_{\text{LINE}}} \times I_{\text{MOT}} \times \frac{\cos \varphi_{\text{MOT}}}{\lambda_{\text{LINE}}}$$

In addition, the field weakening range begins.

The active factor for a synchronous servo motor ( $\cos \phi_{\text{MOT}}$ ) is about 0.9 in 4 kHz operation and about 0.98 in 8 kHz operation. The active factor of an asynchronous motor can be determined according to the accompanying electrical data.

The following is true for the power factor of the supply grid:

$$\lambda_{\text{LINE}} = 0,6 \rightarrow I_{\text{LINE}} < 40\text{A}$$

$$\lambda_{\text{LINE}} = 0,7 \rightarrow I_{\text{LINE}} > 40\text{A}$$

The required motor rating must be calculated in order to determine the necessary supply current and the number and sizes of the drive controllers to be connected to the grid as part of Quick DC-Link.

The overall maximum permitted input current  $I_{\text{maxLINE}}$  is the sum of the maximum input currents of all connected drive controllers in continuous operation. Dynamic movements of the connected motors are possible in the permitted range.

The following is true for the sum of the input currents of the connected drive controllers:

- If the respective power of all drive controllers connected to the grid is identical, the sum of the maximum input currents in the network is calculated using the formula

$$I_{\text{maxLINE}} = 0,8 \times n_{\text{fed}} \times I_{\text{N,PU}}$$

- If the respective power of all drive controllers connected to the grid differs, the sum of the input current is calculated by multiplying the input current of the smallest drive controller connected to the grid by the number of connected drive controllers

$$I_{\text{maxLINE}} = 0,9 \times n_{\text{fed}} \times I_{\text{N,PUmin}}$$

To prevent current asymmetry, all drive controllers connected to the grid with different ratings must contain the same fuse protection, which in turn must correspond to the drive controller with the least power.

### Current load capacity of the copper rails

DC rails connect the DC link capacitors of the drive controllers with one another. They are copper rails that are installed using the quick fastening clamps. DC rails must have a cross-section of 5 x 12 mm. The maximum permitted current load capacity of the copper rails is 200 A.

### Wiring example

The example in the appendix (see [DC link connection \[▶ 438\]](#)) illustrates the basic connection of multiple SD6 drive controllers based on a DC link connection with a DL6A Quick DC-Link.



## 8.3 Motor

During the project configuration for motors, note the framework conditions described below.

### Rotational motors (synchronous servo motors, asynchronous motors, torque motors)

The maximum possible motor speed is limited to 36000 rpm.

The following relationship applies:

$$\text{Rotating magnetic field frequency} = \text{Motor speed} \times \text{Number of pole pairs} \div 60$$

Since the output frequency  $f_{2PU}$  can be a maximum of 700 Hz, the motor speed can only be reached if the calculated rotating magnetic field frequency is less than  $f_{2PU}$ .

The specified torque/speed curve or the nominal points can only be reached in vector control if field weakening operation is not in effect. Theoretical field weakening operation begins when a voltage is required for the speed (speed  $\times$  KE constant) that is greater than the available DC link voltage. In practice, however, field weakening must begin before reaching this voltage limit (control reserve).

You define the voltage limit in B92. The default value is 80%.

### Translational motors (linear motors)

The maximum possible motor velocity is limited to 20,000 m/min.

The following relationship applies:

$$\text{Field frequency} = \text{Velocity in m/min} \times 1000 \div (60 \div \text{pole distance in mm})$$

Since the output frequency  $f_{2PU}$  can be a maximum of 700 Hz, the motor velocity can only be reached if the calculated field frequency is less than  $f_{2PU}$ .

The specified force/velocity curve or the nominal points can only be reached in vector control if field weakening operation is not in effect. Theoretical field weakening operation begins when for the velocity a voltage is required (velocity  $\times$  KE constant) that is greater than the available DC link voltage. In practice, however, field weakening must begin before reaching this voltage limit (control reserve).

You define the voltage limit in B92. The default value is 80%.

## 8.4 Mixed operation

You can combine the SD6 drive controller with other 6th generation STOBER drive controllers.

For a DC link connection in mixed operation, however, only devices of the same series (e.g. SD6) and of same type (e.g. SD6A16) may be supplied with power.

For example, two SC6A261 drive controllers are to be coupled with one SD6A06 drive controller in the DC link. In this case, both SC6A261 drive controllers are connected to the supply grid. The SD6A06 drive controller may only be connected to the DC link of the SC6A261 drive controllers in this case, not to the supply grid.

The graphic below shows an example of the grounding concept in mixed operation with SI6 and SC6 with power from an SD6 drive controller. The grounding conductor connection between the drive controller and the associated Quick DC-Link rear section module (type DL6B or DL6A) is made using the metallic connection of the housings. The grounding conductor connection between DL6B type rear section modules is made using a copper rail (PE rail). Obey the requirements for connecting a 2nd protective grounding conductor to the drive controllers (see [Connection of the grounding conductor](#) [▶ 143]).

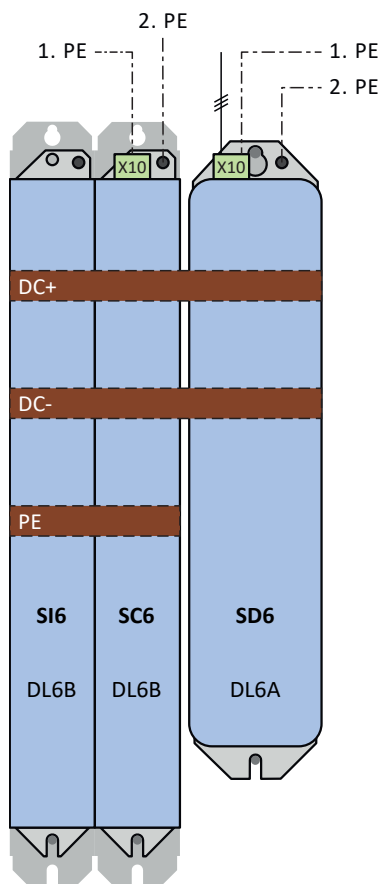

Fig. 14: Grounding concept in mixed operation with SI6 and SC6 with powered SD6 drive controller

If the grounding conductor connection over the 3rd copper rail (PE rail) is omitted between the DL6B rear section modules, the SI6 drive controllers must be grounded to the ground bolt.

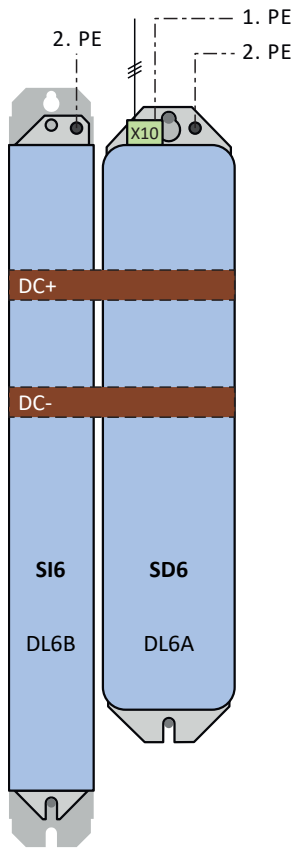

Fig. 15: Grounding concept in mixed operation with SI6 with powered SD6 drive controller

## 8.5 Choke

### 8.5.1 TEP power choke

#### Derating – Effect of surrounding temperature

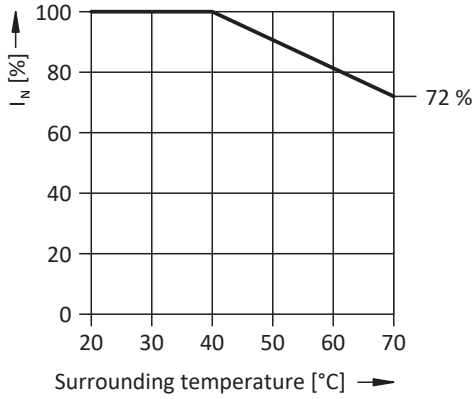

Fig. 16: Derating the nominal current based on surrounding temperature

#### Derating – Effect of the installation elevation

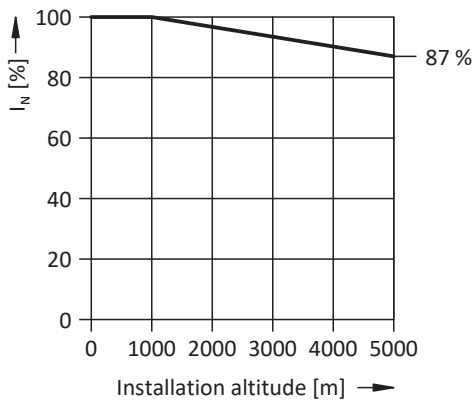

Fig. 17: Derating the nominal current depending on installation elevation

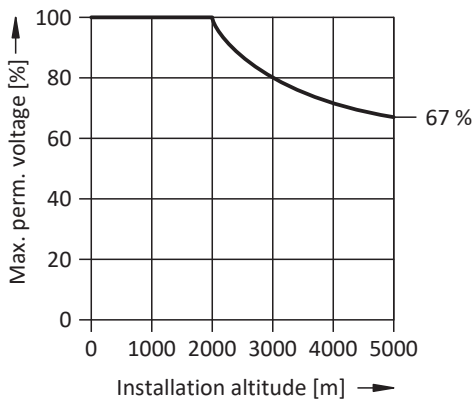

Fig. 18: Derating the voltage depending on installation elevation

### 8.5.2 TEP output choke

Select the output chokes in accordance with the nominal currents of the output chokes, motor and drive controller. In particular, observe the derating of the output choke for rotating magnetic field frequencies higher than 200 Hz. You can calculate the rotating magnetic field frequency for your drive with the following formula:

$$f_N = n_N \times \frac{p}{60}$$

#### Derating – Effect of the clock frequency

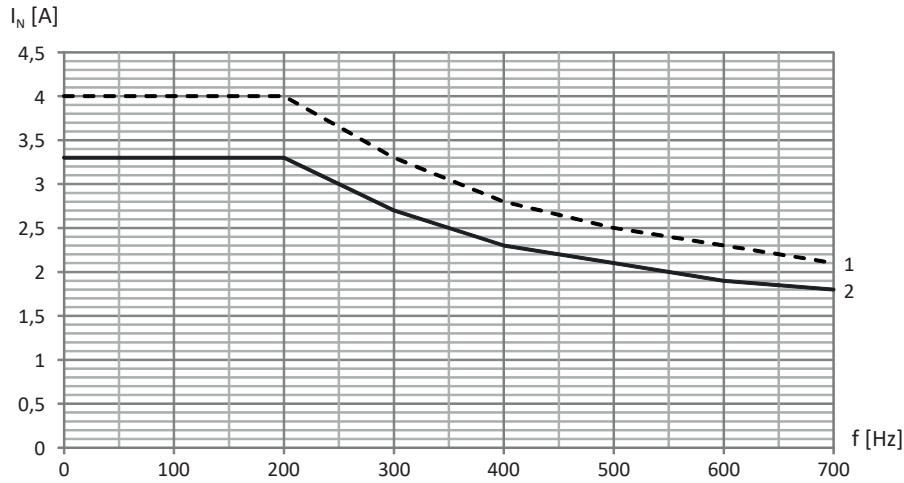

Fig. 19: Derating the nominal current depending on the clock frequency, TEP3720-OES41

- 1 4 kHz clock frequency
- 2 8 kHz clock frequency

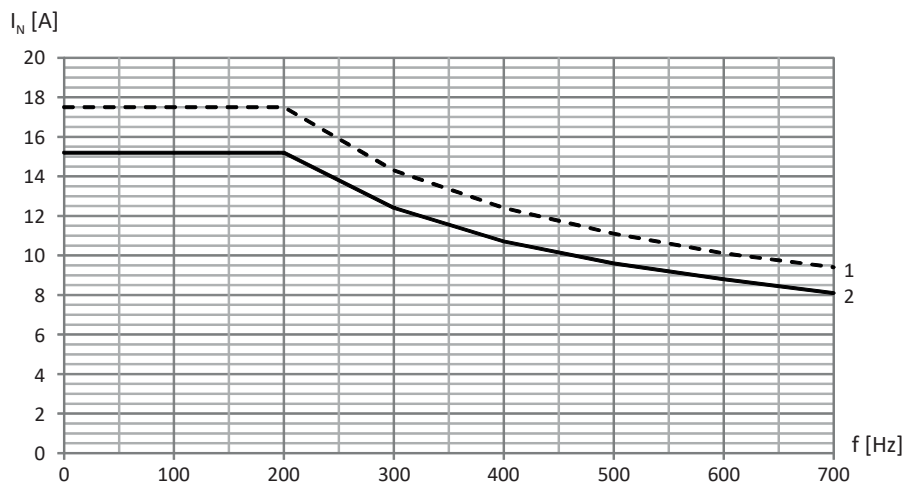

Fig. 20: Derating the nominal current depending on the clock frequency, TEP3820-OCS41

- 1 4 kHz clock frequency
- 2 8 kHz clock frequency

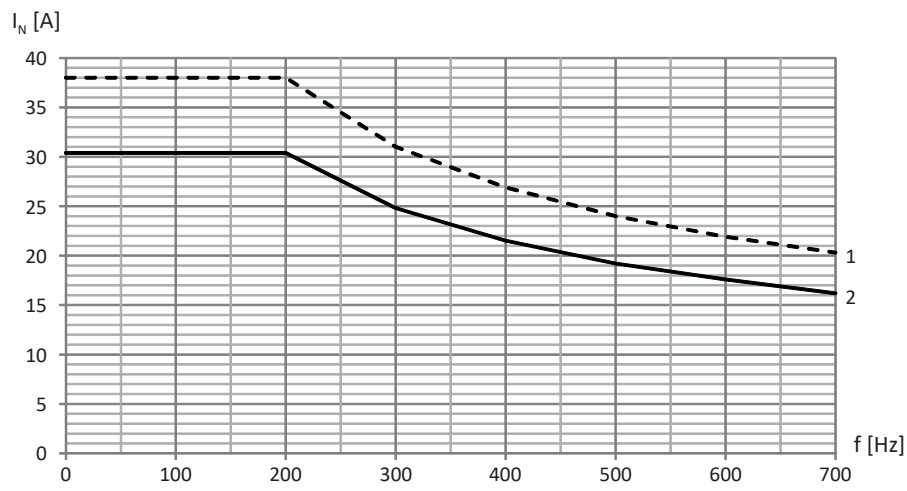

Fig. 21: Derating the nominal current depending on the clock frequency, TEP4020-0RS41

- 1 4 kHz clock frequency
- 2 8 kHz clock frequency

### Derating – Effect of surrounding temperature

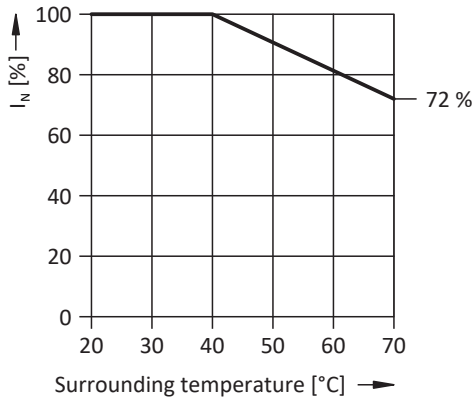

Fig. 22: Derating the nominal current based on surrounding temperature

### Derating – Effect of the installation elevation

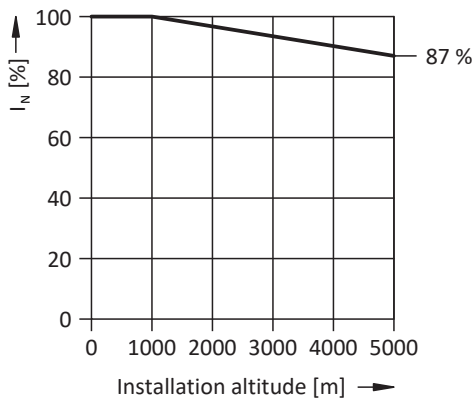

Fig. 23: Derating the nominal current depending on installation elevation

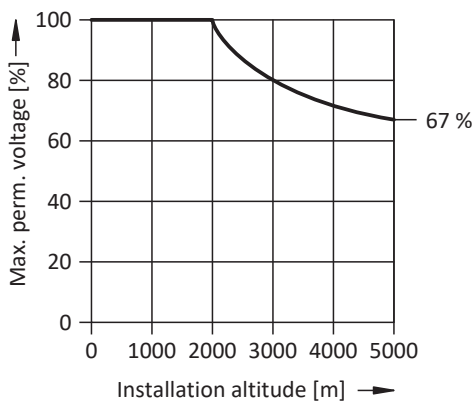

Fig. 24: Derating the voltage depending on installation elevation

## 9 Storage

Store the products in a dry and dust-free room if you do not install them immediately.

Observe the [Transport and storage conditions](#) [▶ 43] specified in the technical data.

### 9.1 Drive controllers

The DC link capacitors can lose their electrical strength due to long storage times and must be reformed before commissioning.

This property does not apply to size 3 DC link capacitors. Therefore, size 3 drive controllers do not require reforming even after prolonged storage periods.

#### ATTENTION!

#### Material damage due to reduced electrical strength!

Reduced electrical strength can cause considerable material damage when switching on the drive controller.

- Reform drive controllers in storage annually or before commissioning.

#### 9.1.1 Annual reforming

To prevent damage to stored drive controllers, STOBER recommends connecting stored devices to the supply voltage once per year for one hour.

The following graphics show the basic line connection for 1-phase and 3-phase devices.

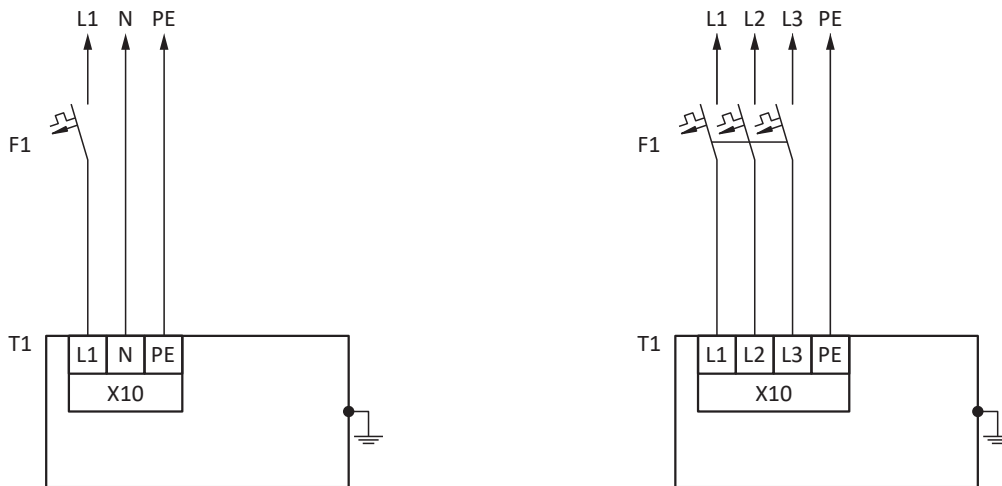

L1 – L3	Lines 1 to 3
N	Neutral conductor
PE	Grounding conductor
F1	Fuse
T1	Drive controller



### 9.1.2 Reforming before commissioning

If annual reforming is not possible, implement reforming on stored devices before commissioning. Note that the voltage levels depend on the storage time.

The following graphic shows the predominant supply connection.

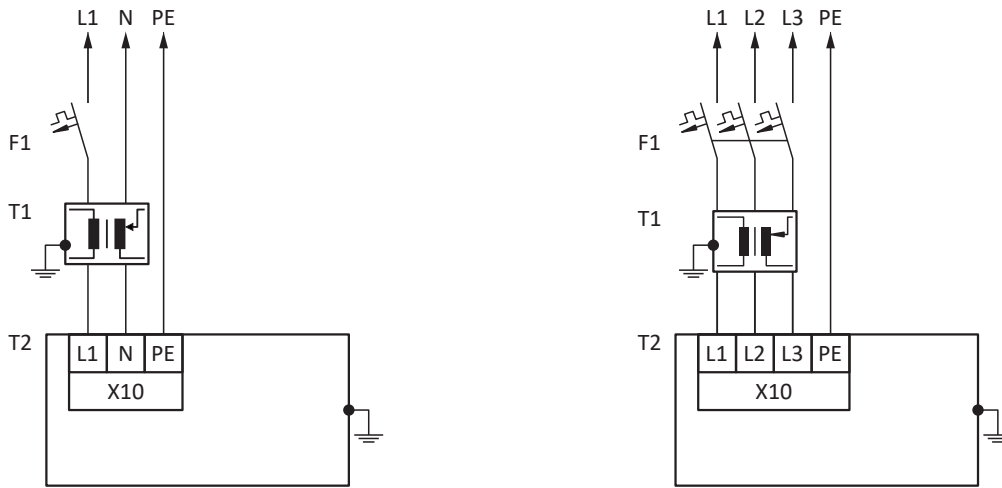

- L1 – L3     Lines 1 to 3
- N            Neutral conductor
- PE          Grounding conductor
- F1          Fuse
- T1          Variable transformer
- T2          Drive controller

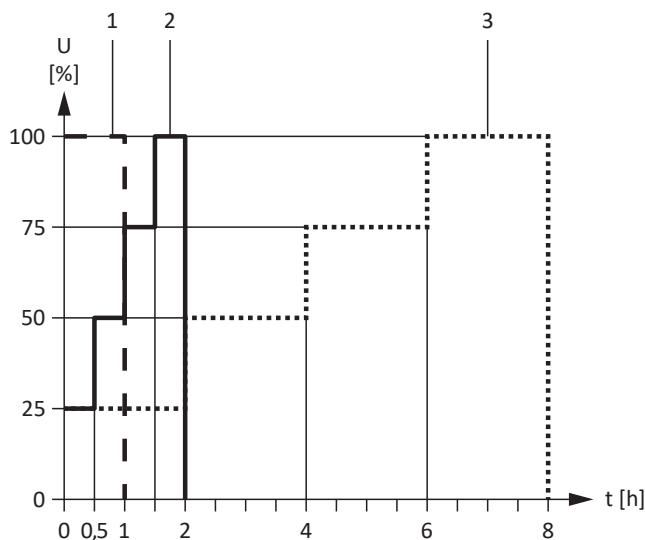

Fig. 25: Voltage levels dependent on storage time

- |   |                              |   |
|---|------------------------------|---|
| 1 | Storage time of 1 – 2 years: | Apply voltage for 1 hour before switching on.                   |
| 2 | Storage time of 2 – 3 years: | Implement reforming according to the graph before switching on. |
| 3 | Storage time ≥ 3 years:      | Implement reforming according to the graph before switching on. |
|   | Storage time < 1 year:       | No actions required.  |

01/2023 | ID 442426.12

## 10 Installation

The following chapters describe the installation of a drive controller and the available accessories.

For information on replacing a drive controller, see [Replacement](#) [▶ 413].

### 10.1 Safety instructions for installation

Installation work is permitted only when no voltage is present. Observe the 5 safety rules (see [Working on the machine](#) [▶ 20]).

To protect the devices from overheating, obey the operating conditions described in the technical data and comply with the required minimum clearances for installation.

Protect the devices against falling parts (bits or strands of wire, pieces of metal, etc.) during installation or other work in the control cabinet. Parts with conductive properties may result in a short circuit inside the devices and device failure as a result.

### 10.2 Basic assembly instructions

Note the points described below for installation.

#### 10.2.1 Drive controllers

Note the following points for installation:

- Prevent condensation, e.g. with anti-condensation heating elements.
- For reasons related to EMC, use installation plates with a conductive surface (unpainted, etc.).
- Avoid installation above or in the immediate vicinity of heat-generating devices, e.g. output chokes or braking resistors.
- To ensure there is sufficient air circulation in the control cabinet, observe the minimum clearances.
- Install the devices vertically.

#### Reference code

Attach a sticker to the front on the device with the unique reference code of the drive controller to prevent mix-ups during installation or replacement.

#### 10.2.2 Braking resistor

Note the permitted mounting positions for the braking resistor.

##### FZMU, FZZMU tubular fixed resistor

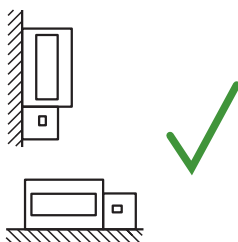

Permitted installation:

- On vertical surfaces with terminals downwards
- On horizontal surfaces
- In control cabinets



Impermissible installation:

- On vertical surfaces with terminals upwards, left or right
- Outside of control cabinets

**GVADU, GBADU flat resistor**

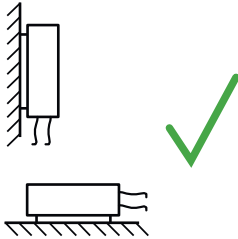

Permitted installation:

- On vertical surfaces with cables downwards
- On horizontal surfaces
- Installation outside of the control cabinet possible for mechanical protection of the conductors



Impermissible installation:

- On vertical surfaces with cables upwards

**FGFKU steel-grid fixed resistor**

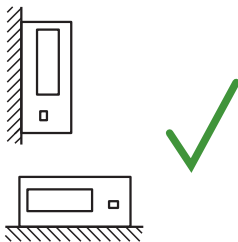

Permitted installation:

- On vertical surfaces with terminals downwards
- Top and bottom perforated sheets
- On horizontal surfaces
- Installation on, next to or in the control cabinet possible



Impermissible installation:

- On vertical surfaces with terminals upwards, left or right

**10.2.3 Choke**

In relation to the flow of cooling air, the following mounting positions are permitted for the TEP output choke:

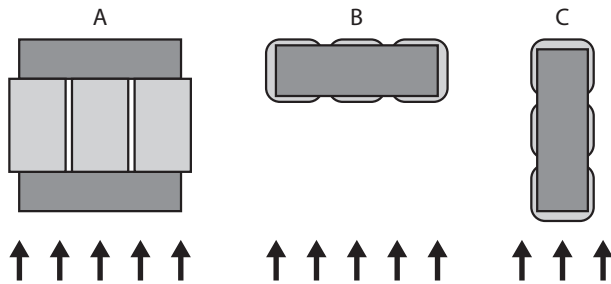

### 10.3 Minimum clearances

Note the minimum clearances for installation below.

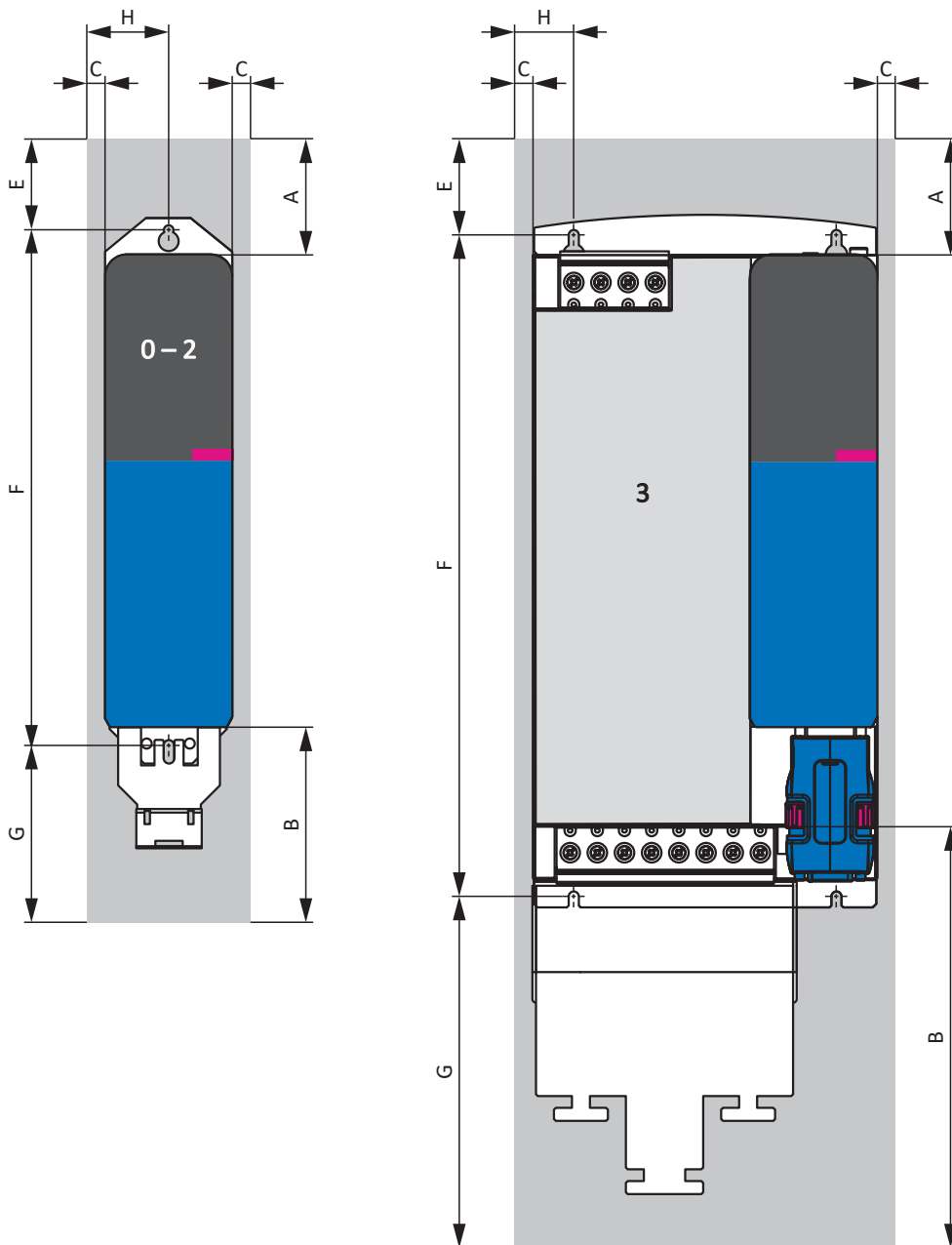

Fig. 26: Minimum clearances

The specified dimensions relate to the outer edges of the drive controller.

Minimum clearance	A (above)	B (below)	C (one the side) <sup>11</sup>
Size 0 – Size 2	100	100	5
... with EMC shroud	100	120	5
Size 3	100	100	5
... with EMC shroud	100	220	5

Tab. 114: Minimum clearances [mm]

<sup>11</sup>Installation without Quick DC-Link module

Dimension	E	F	G	H
Size 0, size 1	86	283+2	approx. 89	40
... with EMC shroud	86	283+2	approx. 109	40
Size 2	86	283+2	approx. 89	57.5
... with EMC shroud	86	283+2	approx. 109	57.5
Size 3	89	365+2	approx. 59.5	25
... with EMC shroud	89	365+2	approx. 179.5	25

Tab. 115: Dimensions [mm]

### Chokes and filters

Avoid installation below drive controllers or supply modules. For installation in a control cabinet, a distance of approximately 100 mm to other neighboring components is recommended. This distance ensures proper heat dissipation for chokes and filters.

### Braking resistors

Avoid installation below drive controllers or supply modules. In order for heated air to flow out unimpeded, a minimum clearance of approximately 200 mm must be maintained in relation to neighboring components or walls and approximately 300 mm must be maintained to components above or ceilings.

## 10.4 Drilling diagrams and bore dimensions

Drilling diagrams and dimensions can be found in the following chapters.

### 10.4.1 Drive controllers

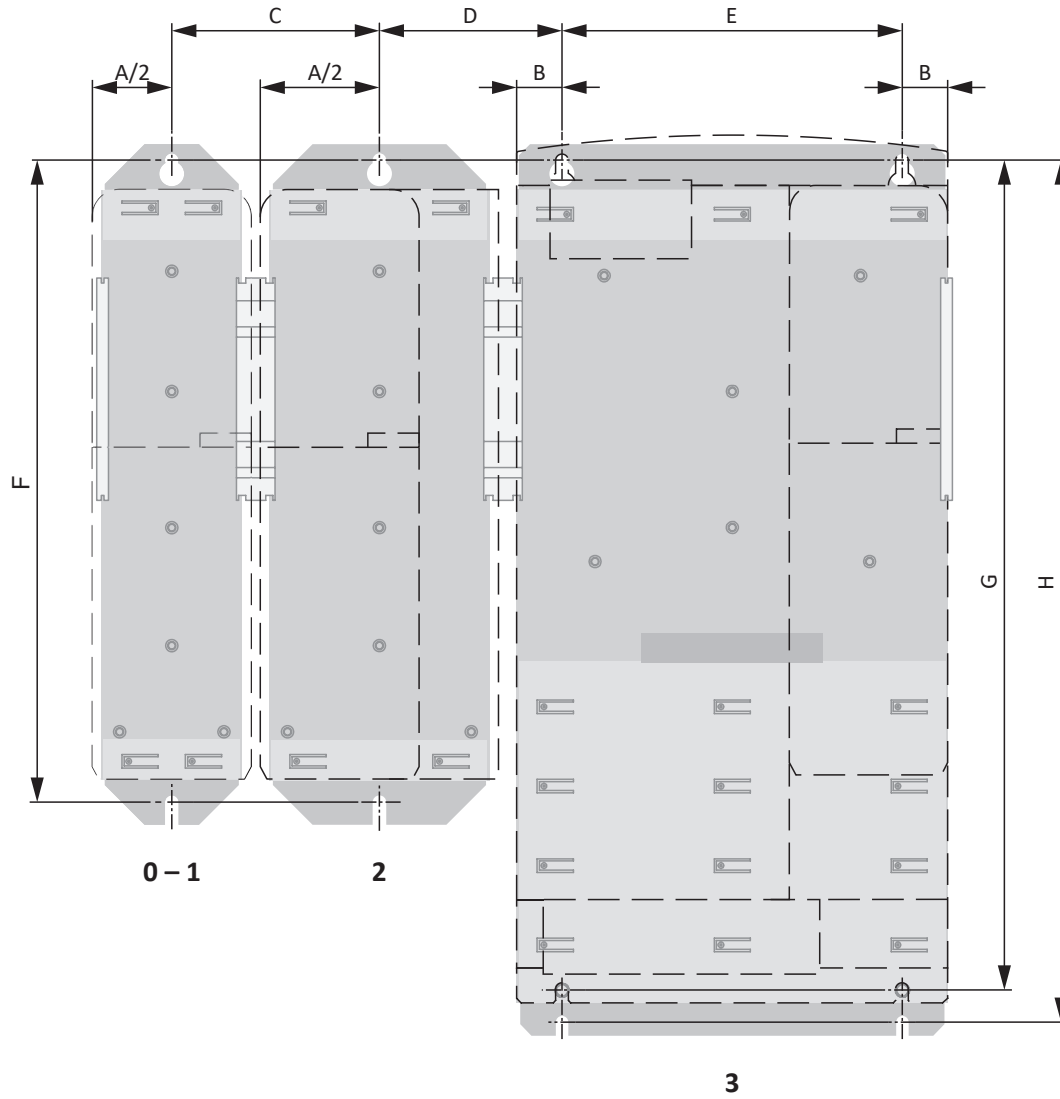

Fig. 27: SD6 and DL6A drilling diagram

The drilling dimensions depend on the selected design.

The following specifications apply to installation without a rear section module:

SD6 dimension		Size 0, size 1	Size 2	Size 3	
Horizontal fastening holes of SD6 Ø 4.2 (M5)	A	70	105	—	
	B	—	—	20	
	E	—	—	150+0.2/-0.2	
	C	Size 0, size 1	76±1	93.5±1	—
	C	Size 2	93.5±1	111±1	—
	D	Size 0, size 1	—	—	61±1
	D	Size 2	—	—	78.5±1
	D	Size 3	—	—	46±1
Vertical fastening holes of SD6 Ø 4.2 (M5)	F	283+2	283+2	—	
	G	—	—	365+2	

Tab. 116: Drilling dimensions for SD6 drive controller [mm]

The following specifications apply to installation with a DL6A Quick DC-Link or rear section braking resistor:

Dimension of DL6A / rear section braking resistor		Size 0, size 1	Size 2	Size 3	
Horizontal fastening holes for rear section modules Ø 4.2 (M5)	A	70	105	—	
	B	—	—	20	
	E	—	—	150+0.2/-0.2	
	C	Size 0, size 1	74+1	91.5+1	—
	C	Size 2	91.5+1	109+1	—
	D	Size 0, size 1	—	—	63+1
	D	Size 2	—	—	80.5+1
	D	Size 3	—	—	52+1
Vertical fastening holes for rear section modules Ø 4.2 (M5)	F	283+2	283+2	—	
	H	—	—	380+2	

Tab. 117: Drilling dimensions for DL6A Quick DC-Link or rear section braking resistor [mm]

### 10.4.2 Braking resistor

#### 10.4.2.1 FZMU, FZZMU tubular fixed resistor

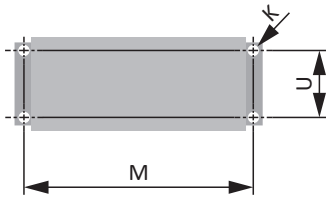

Fig. 28: FZMU, FZZMU drilling diagram

Dimension	FZMU 400×65	FZZMU 400×65
K	6.5 × 12	6.5 × 12
M	430	426
U	64	150

Tab. 118: FZMU, FZZMU dimensions [mm]

#### 10.4.2.2 GVADU, GBADU flat resistor

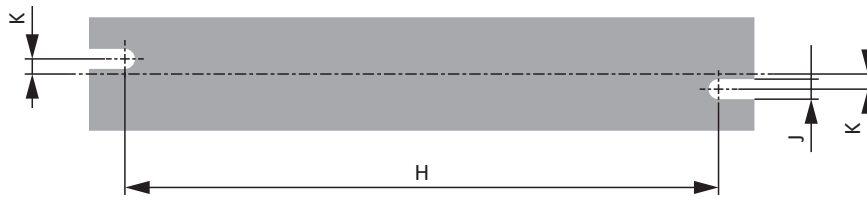

Fig. 29: GVADU, GBADU drilling diagram

Dimension	GVADU 210×20	GBADU 265×30	GBADU 405×30	GBADU 335×30	GBADU 265×30
H	192	246	386	316	246
K	2.5	4	4	4	4
J	4.3	5.3	5.3	5.3	5.3

Tab. 119: GVADU, GBADU dimensions [mm]



### 10.4.2.3 FGFKU steel-grid fixed resistor

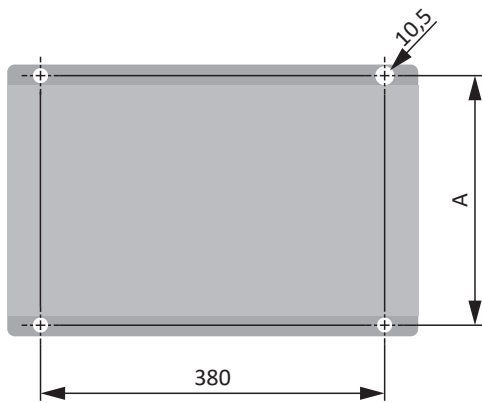

Fig. 30: FGFKU drilling diagram

Dimension	FGFKU 3100502	FGFKU 3111202	FGFKU 3121602
A	270	370	570

Tab. 120: FGFKU dimensions [mm]

### 10.4.2.4 RB 5000 rear section braking resistor

#### Information

Note the dimensional data in the drilling diagram (see [Drive controllers \[► 110\]](#)) for the installation of the drive controller with rear section braking resistor.

## 10.4.3 Choke

### 10.4.3.1 TEP power choke

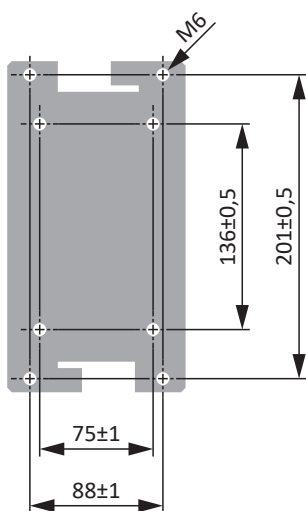

Fig. 31: Power choke drilling diagram

### 10.4.3.2 TEP output choke

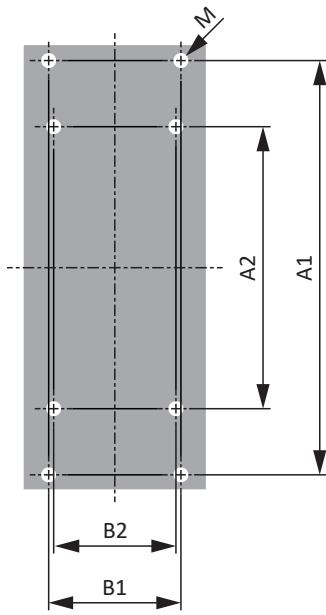

Fig. 32: TEP drilling diagram

Dimension	TEP3720-0ES41	TEP3820-0CS41	TEP4020-0RS41
Vertical distance – Fastening holes A1 [mm]	166	166	201
Vertical distance – Fastening holes A2 [mm]	113	113	136
Horizontal distance – Fastening holes B1 [mm]	53	68	89
Horizontal distance – Fastening holes B2 [mm]	49	64	76
Drill holes – Depth E [mm]	5.8	5.8	7
Drill holes – Width F [mm]	11	11	13
Screw connection – M	M5	M5	M6

Tab. 121: TEP dimensions

### 10.5 Length of copper rails

If you would like to connect SD6 drive controllers in the DC link group using a DL6A Quick DC-Link, you need two copper rails with a cross-section of 5 × 12 mm in the correct length.

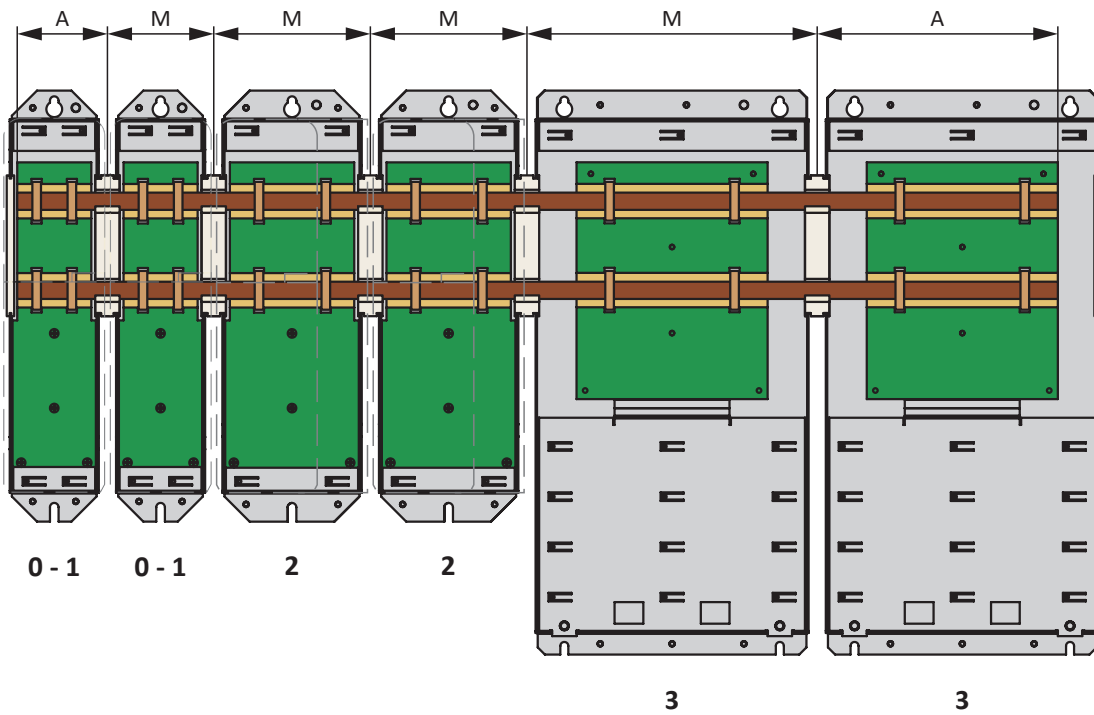

Note the following specifications for determining the length:

Position	Dimension	Size 0, size 1	Size 2	Size 3
Beginning or end of the group	A	62	97	167
Within the group	M	74	109	202

Tab. 122: Determination of the correct length of the copper rails [mm]

## 10.6 Installing the communication module

In order to connect EtherCAT, CANopen or PROFINET, you need an EC6, CA6 or PN6 communication module. The communication module is installed in the upper slot. Installation is identical for all communication modules.

### WARNING!

#### Electrical voltage! Risk of fatal injury due to electric shock!

- Always switch off all power supply voltage before working on the devices!
- Note the discharge time of the DC link capacitors in the general technical data. You can only determine the absence of voltage after this time period.

### ATTENTION!

#### Damage to property due to electrostatic discharge!

Take appropriate measures when handling exposed circuit boards, e.g. wearing ESD-safe clothing.

Do not touch contact surfaces.

#### Tools and material

You will need:

- A TORX screwdriver TX10
- The cover and screws included with the communication module

#### Installation

1. Unscrew the fastening screw of the dummy cover on top of the drive controller and remove the cover.

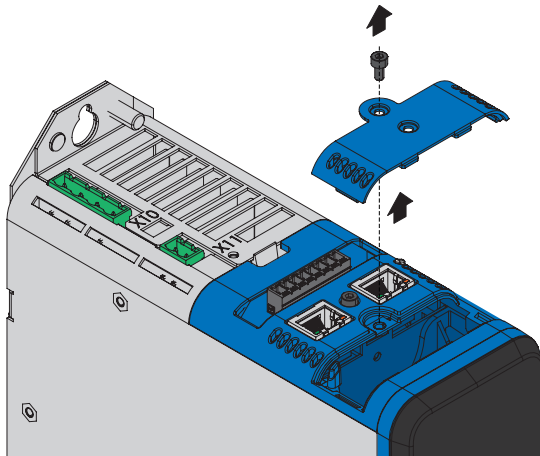

- Slide the communication module on the guide rails into the drive controller.

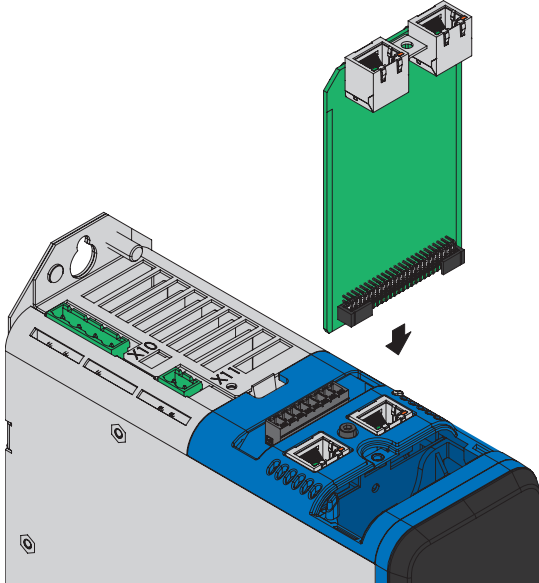

- Press on the module in order to push the pin contacts into the box header.
- Set the tabs of the cover included with the communication module in front into the notch at an angle.

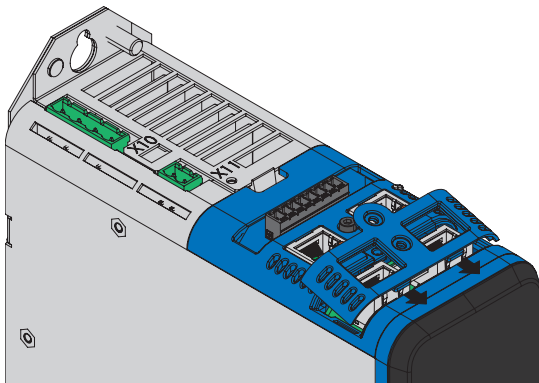

- Place the cover on the drive controller so that the tabs lie under the edge.

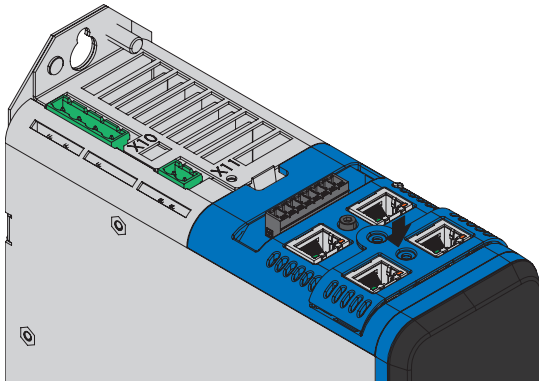

- Attach the cover using both screws.

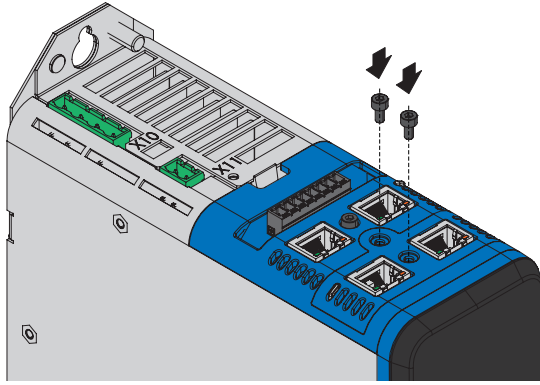

## 10.7 Installing the terminal module

Analog and digital signals can be connected only by means of XI6, RI6 or IO6 terminal modules. Installation is identical for all terminal modules.

### WARNING!

#### Electrical voltage! Risk of fatal injury due to electric shock!

- Always switch off all power supply voltage before working on the devices!
- Note the discharge time of the DC link capacitors in the general technical data. You can only determine the absence of voltage after this time period.

### ATTENTION!

#### Damage to property due to electrostatic discharge!

Take appropriate measures when handling exposed circuit boards, e.g. wearing ESD-safe clothing.

Do not touch contact surfaces.

#### Tools and material

You will need:

- A TX10 Torx screwdriver
- The accessories included with the terminal module

#### Installation

- Lightly press the snap closure on the front cover to unlock it.

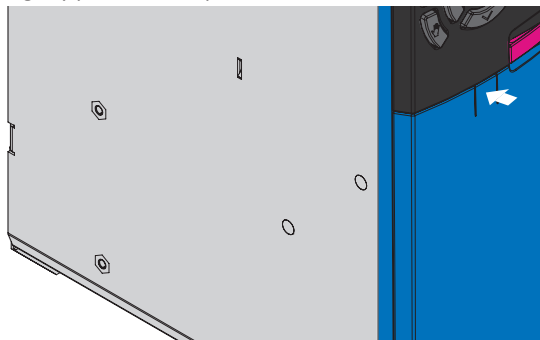

2. Push the front cover down as far as it will go.

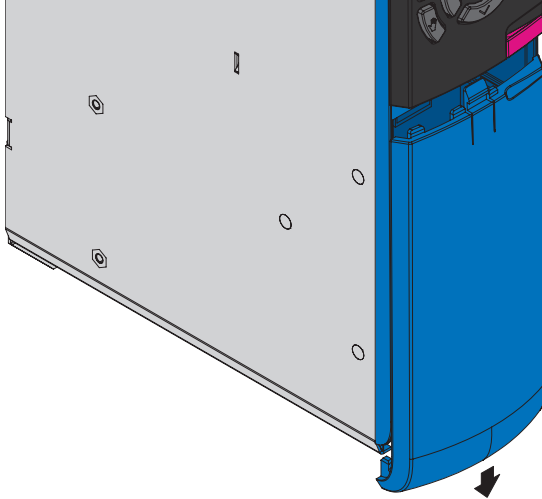

3. Pull the cover forwards to remove it.

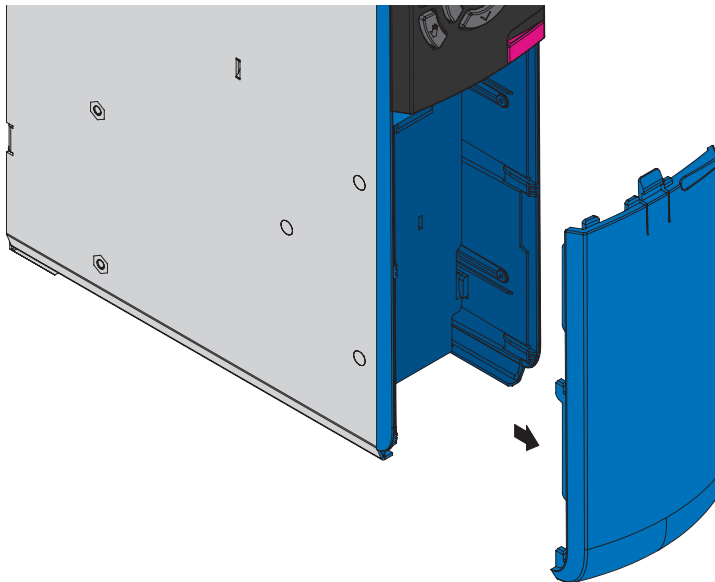

4. Insert the terminal module so that the notches of the module as well as the hold-down devices on the drive controller can be guided past each other. The rear side of the module touches the drive controller.

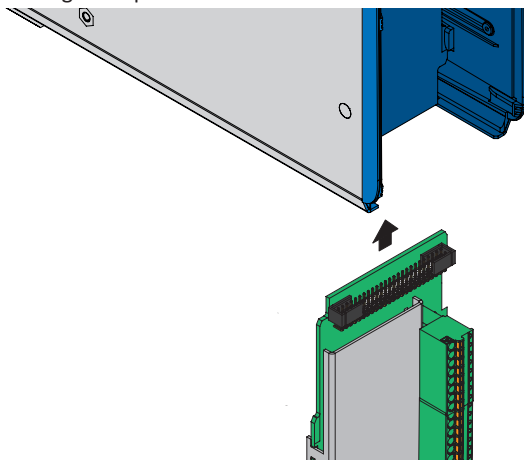

5. Push the terminal module upwards so that the pin contacts are pushed into the box header.

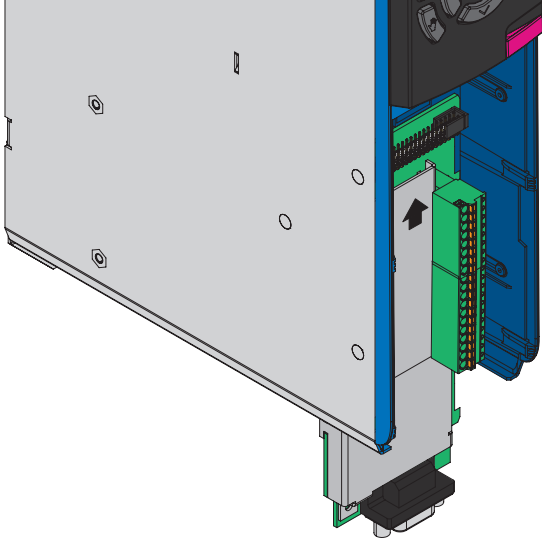

6. Fasten the terminal module to the drive controller using the fastening screw.

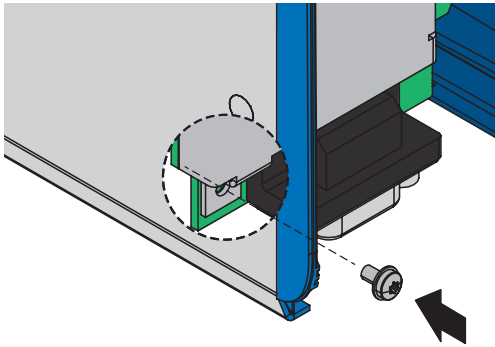



## 10.8 Installing the drive controller without a rear section module

This chapter describes the installation of the SD6 drive controller without a rear section module. If you would like to connect SD6 drive controllers in the DC link or insert rear section braking resistors, you must mount the required rear section modules and then build the appropriate drive controllers over them.

### **WARNING!**

#### **Electrical voltage! Risk of fatal injury due to electric shock!**

- Always switch off all power supply voltage before working on the devices!
- Note the discharge time of the DC link capacitors in the general technical data. You can only determine the absence of voltage after this time period.

### **Information**

Note that drive controllers in storage require reforming each year or before commissioning at the latest.

#### **Tools and material**

You will need:

- Fastening screws
- Tool for tightening the fastening screws

#### **Requirements and installation**

Perform the following steps for each drive controller within the group and in the specified order.

- ✓ In accordance with the drilling diagram, taking into consideration the various device dimensions, you have made threaded holes for the threaded bolts on the mounting plate at the mounting position.
  - ✓ The mounting plate has been cleaned (free of oil, grease and swarf).
1. If present, install the communication module (see [Installing the communication module \[▶ 116\]](#)).
  2. If present, install the terminal module (see [Installing the terminal module \[▶ 118\]](#)).
  3. Size 3: Mount the EM6A3 EMC shroud (see [Attaching the EMC shroud \[▶ 132\]](#)).
  4. Fasten the top of the drive controller on the mounting plate.
  5. Sizes 0 to 2: Mount the EM6A0 EMC shroud (see [Attaching the EMC shroud \[▶ 132\]](#)).
  6. Fasten the bottom of the drive controller on the mounting plate.
  7. Connect the grounding conductor to the ground bolt. Obey the instructions and requirements for [Protective grounding \[▶ 142\]](#).
- ⇒ The installation is completed. In the next step, connect the drive controller.

## 10.9 Installing the DC link connection

If you would like to connect the SD6 drive controllers in the DC link group, you must first mount the Quick DC-Link modules of type DL6A and then build the appropriate drive controllers over them.

### Information

Note that you cannot combine DL6A Quick DC-Link modules and RB 5000 rear section braking resistors within a group.

### WARNING!

#### Electrical voltage! Risk of fatal injury due to electric shock!

- Always switch off all power supply voltage before working on the devices!
- Note the discharge time of the DC link capacitors in the general technical data. You can only determine the absence of voltage after this time period.

#### Tools and material

You will need:

- 2 copper rails with a cross-section of 5 x 12 mm in the correct length (see [Length of copper rails](#) [▶ 115])
- The M5 threaded bolts included with the Quick DC-Link modules and the accompanying screw and washer assemblies (screws with flat and spring washers)
- An 8 mm hexagonal socket wrench
- The insulation connection pieces and quick fastening clips included with the Quick DC-Link modules
- The insulation end sections for the left and right termination of the group that are available separately

#### Requirements and installation

Perform the following steps in the specified order.

- ✓ In accordance with the drilling diagram, taking into consideration the various device dimensions, you have made threaded holes for the threaded bolts on the mounting plate at the mounting position.
- ✓ The mounting plate has been cleaned (free of oil, grease and swarf).
- ✓ The copper rails must be straight, smooth, free of burrs and cleaned (free of oil and grease).

1. Fasten the Quick DC-Link modules to the mounting plate using the threaded bolts.

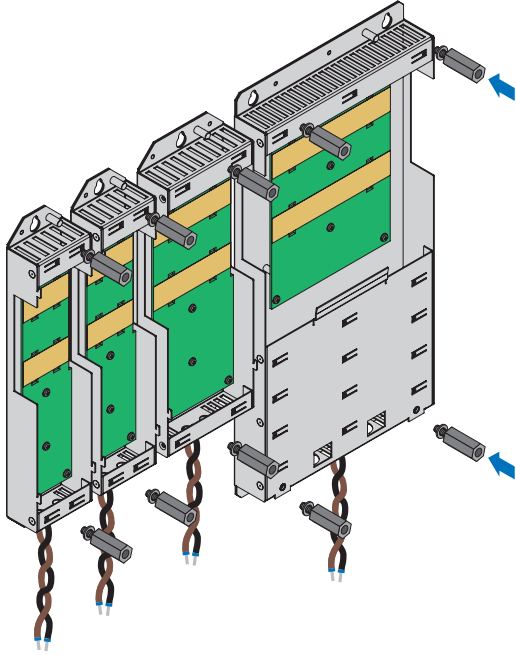

2. Insert the insulation connection pieces between the modules and insulation end section each at the left edge of the first module and at the right edge of the last module.

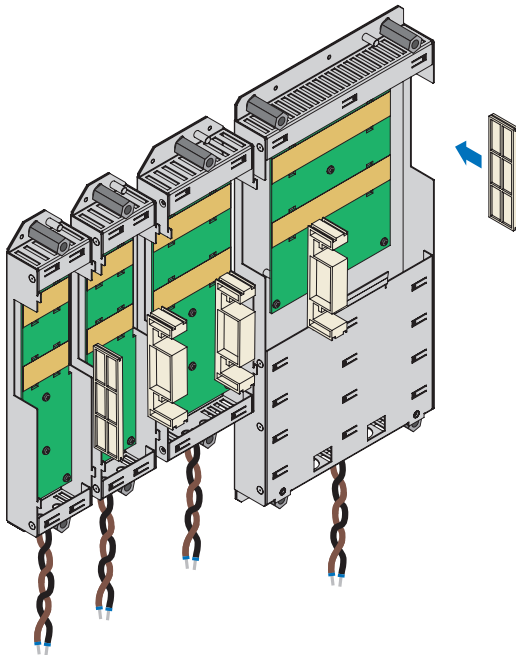

3. Clean the copper rails, especially at the contact points.

4. Insert both copper rails one after the other.

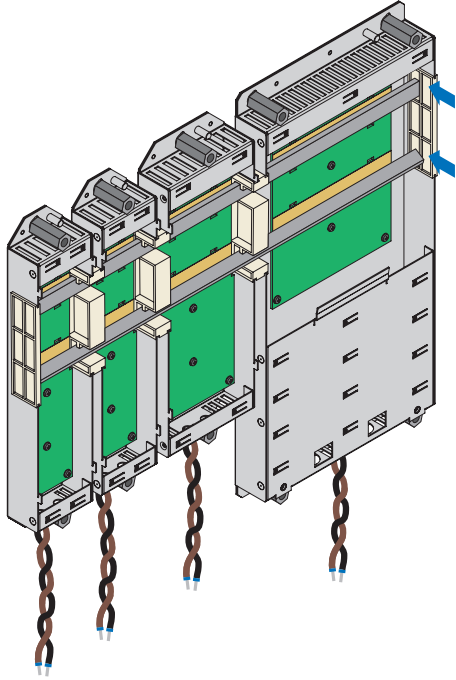

5. Fasten each of the copper rails with two quick fastening clamps per rail and Quick DC-Link module. Make certain the contact points of the copper rails do not become contaminated.

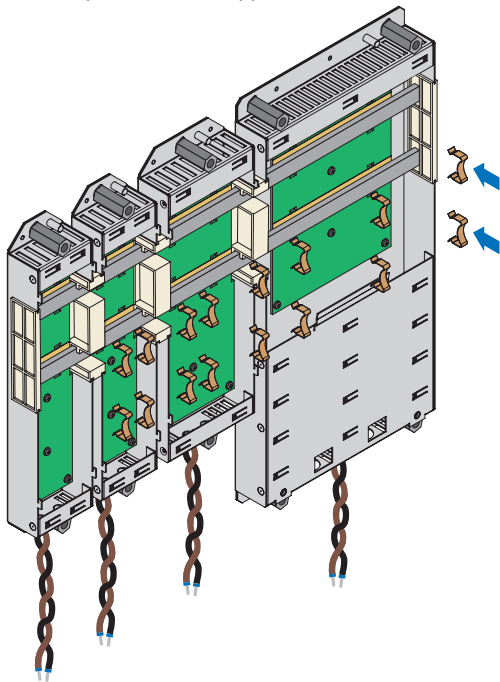

- ⇒ You have installed the Quick DC-Link. In the next step, build over the Quick DC-Link modules with the appropriate drive controllers.

## 10.10 Installing a rear section braking resistor

If you employ the RB 5000 rear section braking resistor provided for drive controllers of sizes 0 to 2, you must mount it first and then build over with the appropriate drive controller.

### Information

Note that you cannot combine DL6A Quick DC-Link modules and RB 5000 rear section braking resistors within a group.

### WARNING!

#### Electrical voltage! Risk of fatal injury due to electric shock!

- Always switch off all power supply voltage before working on the devices!
- Note the discharge time of the DC link capacitors in the general technical data. You can only determine the absence of voltage after this time period.

#### Tools and material

You will need:

- The M5 threaded bolts included with the rear section braking resistor and the accompanying screw and washer assemblies (screws with flat and spring washers)
- An 8 mm hexagonal socket wrench

#### Requirements and installation

- ✓ In accordance with the drilling diagram, taking into consideration the various device dimensions, you have made threaded holes for the threaded bolts on the mounting plate at the mounting position.
  - ✓ The mounting plate has been cleaned (free of oil, grease and swarf).
1. Fasten the rear section braking resistor to the mounting plate using the threaded bolts.

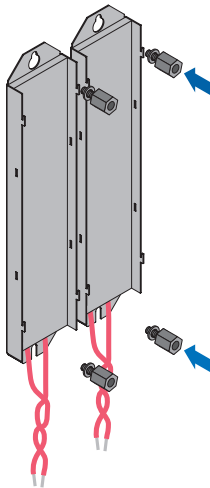

- ⇒ You have installed the rear section braking resistor. In the next step, build over it with the appropriate drive controller.

## 10.11 Mounting the drive controller on the rear section module

### **WARNING!**

#### **Electrical voltage! Risk of fatal injury due to electric shock!**

- Always switch off all power supply voltage before working on the devices!
- Note the discharge time of the DC link capacitors in the general technical data. You can only determine the absence of voltage after this time period.

### **Information**

Note that drive controllers in storage require reforming each year or before commissioning at the latest.

#### **Tools and material**

You will need:

- A PH2 Phillips-head screwdriver

#### **Requirements and installation**

Perform the following steps for each drive controller within the group and in the specified order. For size 3 drive controllers, note that terminal X20 cannot be disconnected.

- ✓ There is a circuit diagram of the system that describes the connection of the drive controllers.
  - ✓ For each drive controller, the appropriate DL6A Quick DC-Link rear section modules or rear section braking resistors have already been installed in the installation position.
1. If present, install the communication module; see chapter [Installing the communication module \[▶ 116\]](#).
  2. If present, install the terminal module; see the chapter [Installing the terminal module \[▶ 118\]](#).
  3. Size 3: Mount the EM6A3 EMC shroud; see the chapter [Attaching the EMC shroud \[▶ 132\]](#).
  4. Sizes 0 to 2: Disconnect the X30 terminal from the drive controller.

Further action varies depending on the type of rear section module.

### Mounting on a Quick DC-Link module

1. Sizes 0 to 2: Connect the brown cable to D+ of terminal X30 and the black cable to D- of terminal X30. Make sure that the conductors of the Quick DC-Link module are twisted pairs.

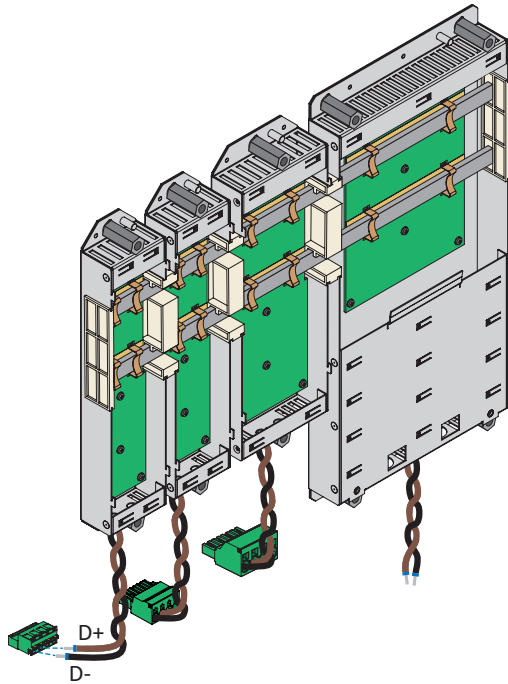

2. Position the drive controller on the guides of the rear section module.

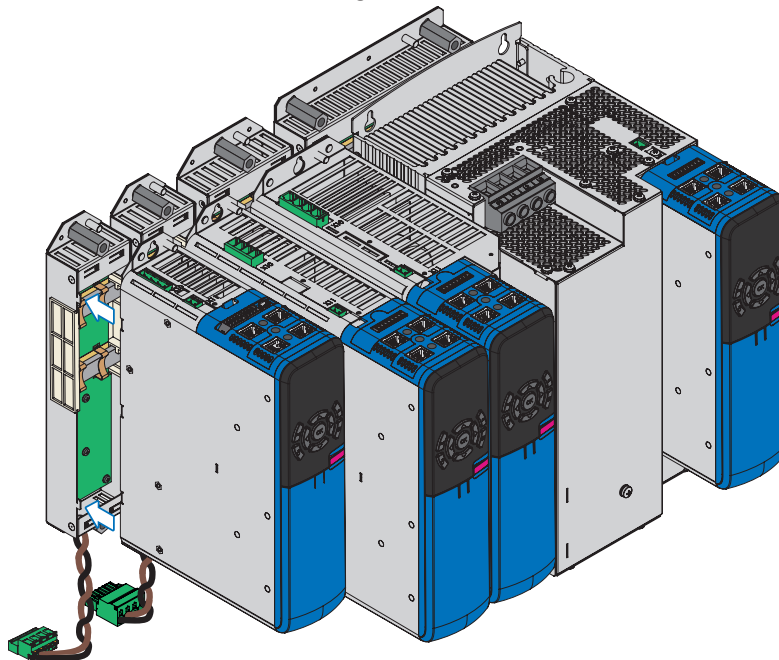

3. Press the drive controller downward onto the guides.

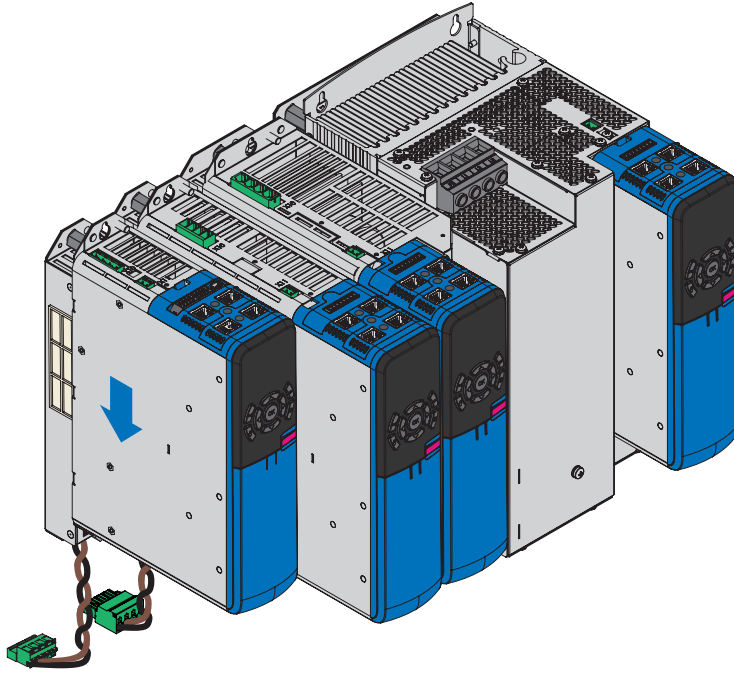

4. Sizes 0 to 2: Mount the EM6A0 EMC shroud; see the chapter [Attaching the EMC shroud](#) [▶ 132].
5. Attach the drive controller to the threaded bolts using the screw and washer assemblies.

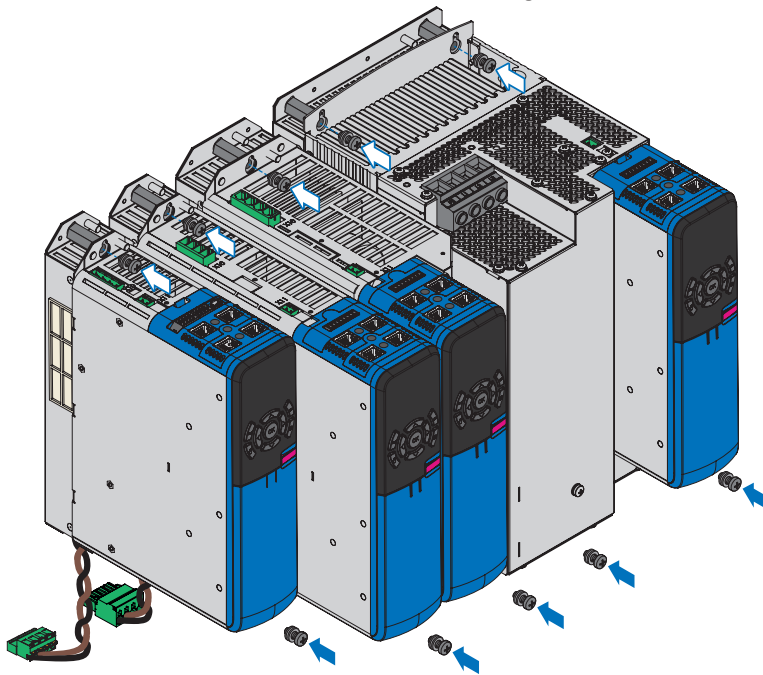

6. Connect the grounding conductor of the rear section module to the ground bolt of the rear section module and the grounding conductor of the drive controller to the ground bolt of the drive controller. Note the instructions and requirements in chapter [Protective grounding](#) [▶ 142].



7. Sizes 0 to 2: Attach terminal X30 on the underside of the drive controller.  
Size 3: Connect the brown cable to D+ of terminal X20 and the black cable to D- of terminal X20. Ensure that the connection lines of the Quick DC-Link module are twisted pairs.

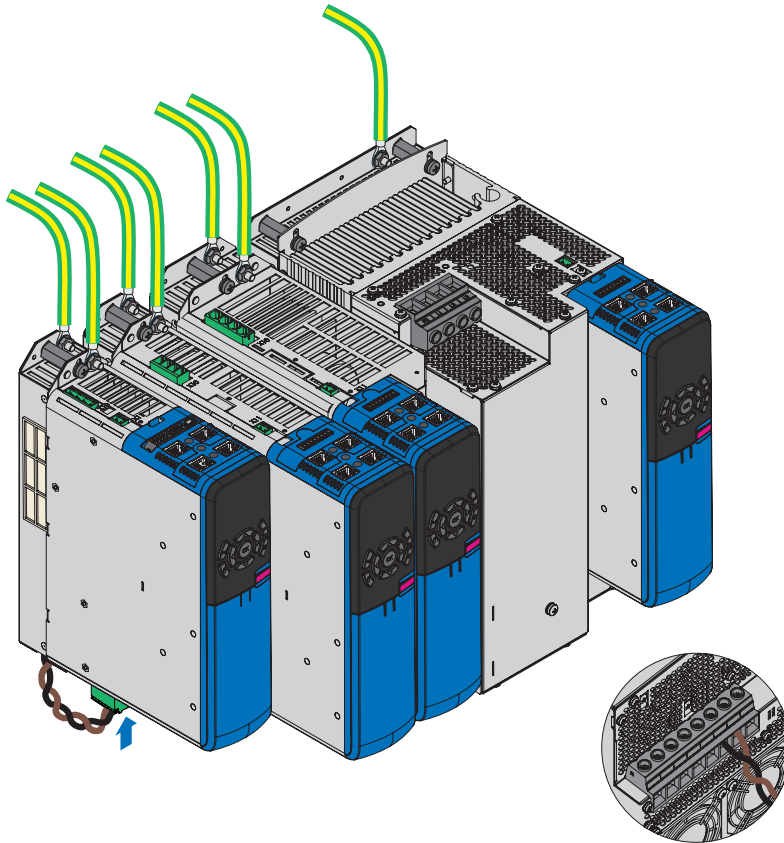

- ⇒ The installation is completed. In the next step, connect the drive controller.

### Mounting on a rear section braking resistor

1. Sizes 0 to 2: Connect the two cables to R+ and R- of terminal X30. Ensure that the connection lines of the braking resistor are twisted pairs.

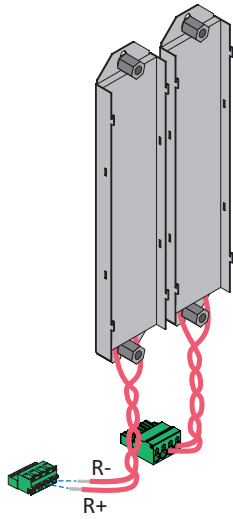

2. Position the drive controller on the guides of the rear section module.

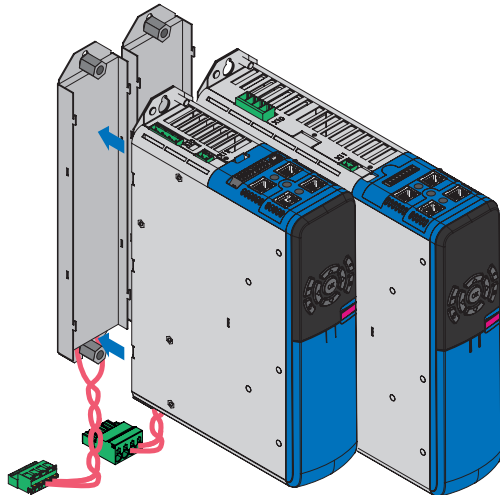

3. Press the drive controller downward onto the guides.

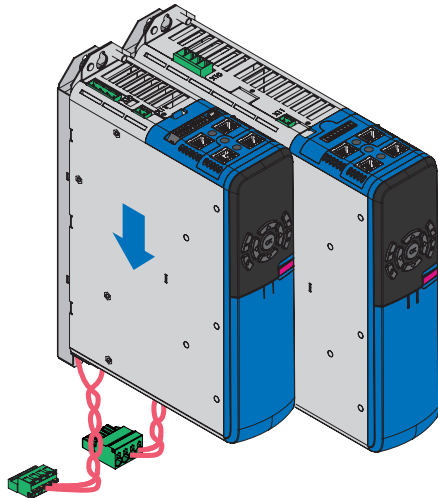

4. Sizes 0 to 2: Mount the EM6A0 EMC shroud; see the chapter [Attaching the EMC shroud](#) [▶ 132].

5. Attach the drive controller to the threaded bolts using the screw and washer assemblies.

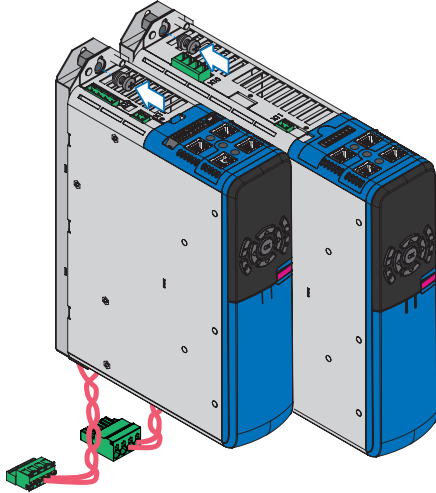

6. Connect the grounding conductor of the drive controller to the ground bolt of the drive controller. Note the instructions and requirements in chapter [Connection of the grounding conductor](#) [▶ 143].
7. Sizes 0 to 2: Attach terminal X30 on the underside of the drive controller.

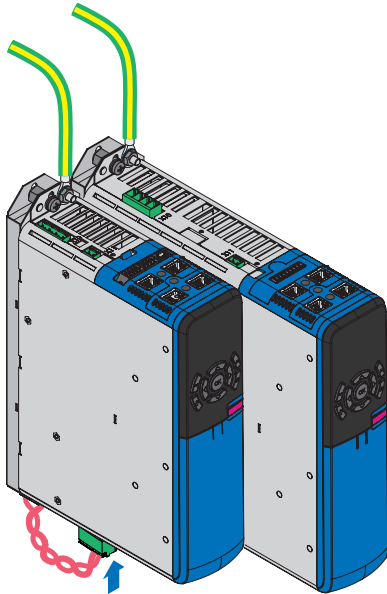

- ⇒ The installation is completed. In the next step, connect the drive controller.

## 10.12 Attaching the EMC shroud

The EMC shroud is used to be able to apply the cable shield of the power cable. You need the EM6A0 shroud for drive controllers of sizes 0 to 2 and the EM6A3 shroud for size 3. Due to the different designs, the attachment of this accessory part to the drive controllers is also different.

### WARNING!

#### Electrical voltage! Risk of fatal injury due to electric shock!

- Always switch off all power supply voltage before working on the devices!
- Note the discharge time of the DC link capacitors in the general technical data. You can only determine the absence of voltage after this time period.

#### Tools and material

You will need:

- A PH2 Phillips-head screwdriver
- EM6A3: The two screw and washer assemblies included with the shroud (screw with tooth lock washer, M4×8)

#### Attaching the EM6A0 to a drive controller up to size 2

- ✓ The drive controller is already installed in the control cabinet, in combination with a Quick DC-Link or a rear section braking resistor if applicable.

1. Unscrew the bottom fastening screw and flat washer of the drive controller.

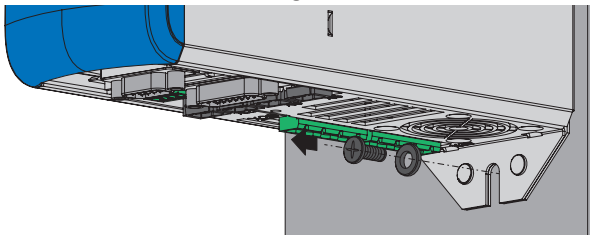

2. Insert the shroud at a slight angle into the openings on the underside of the drive controller.

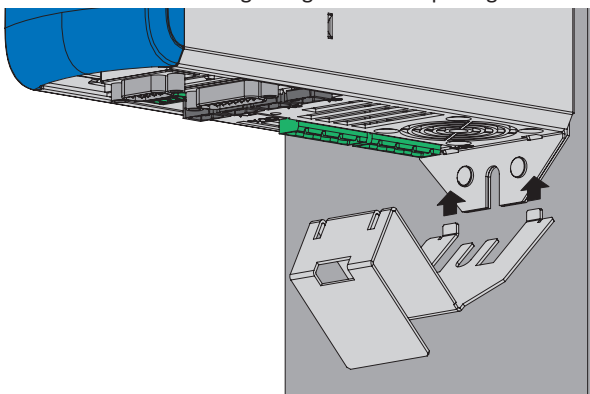

3. Press the rear side of the shroud either onto the mounting plate directly or onto the threaded bolts of the rear section module.

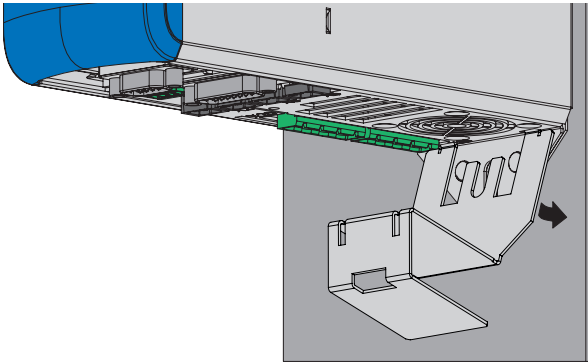

4. Fasten the shroud using the fastening screw and flat washers to the drive controller and mounting plate or threaded bolt.

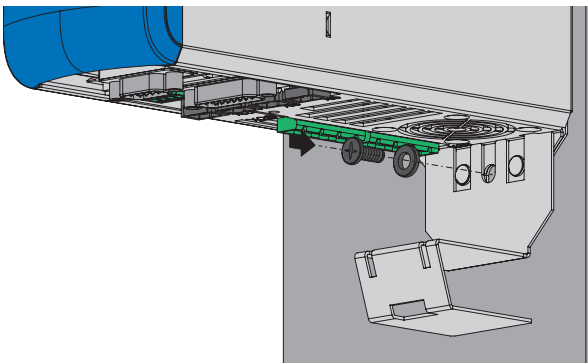

### Attaching the EM6A3 to a drive controller of size 3

1. Before installing the drive controller, fasten the shroud to the underside of the drive controller in the threaded holes provided for this purpose using the included screw and washer assemblies (max. tightening torque: 2.4 Nm).

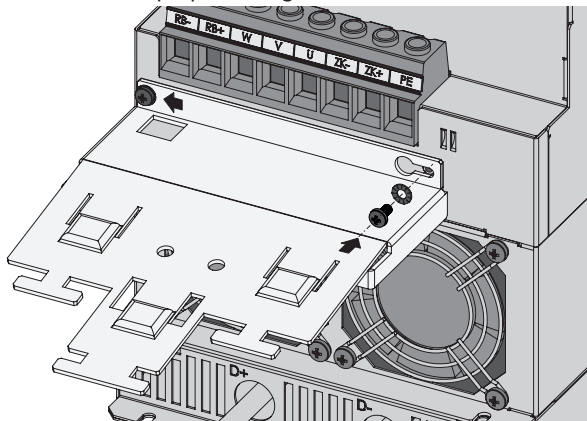

## 10.13 Installing the encoder adapter box

The LA6 adapter box should be mounted right next to the drive controller. The permitted installation options are described below.

### **WARNING!**

#### **Electrical voltage! Risk of fatal injury due to electric shock!**

- Always switch off all power supply voltage before working on the devices!
- Note the discharge time of the DC link capacitors in the general technical data. You can only determine the absence of voltage after this time period.

#### **DIN rail attachment**

✓ You have already mounted 35 mm wide, symmetrical DIN rails in accordance with EN 50022 (TS 35).

1. Place the spring of the mounting aid on the rear side of the adapter box on the DIN rail.
2. Press the adapter box upward and back until the clamping mechanism audibly locks in.

#### **Screw fastening**

#### **Tools and material**

You will need:

- A TX10 Torx screwdriver for unscrewing the assembly aid
  - Two M5 fastening screws
  - Tool for tightening the fastening screws
1. Before assembly, remove the mounting aid on the rear side of the adapter box by unscrewing both screws.
  2. Fasten the adapter box to the mounting plate using the M5 screws.

# 11 Connection

The following chapter describes the connection of the drive controller and the available accessories.

## 11.1 Safety instructions for connection

Connection work is permitted only when no voltage is present. Observe the 5 safety rules (see [Working on the machine](#) [▶ 20]).

If you couple the drive controller in the DC link, ensure that all Quick DC-Link modules are built over with a drive controller.

The device housing must be closed before you turn on the supply voltage.

When the power supply voltage is turned on, hazardous voltages may be present on the connection terminals and the cables connected to them.

The device and the cables connected to it are not necessarily de-energized when the supply voltage is switched off and all displays have gone out!

### Information

Note the discharge time of the DC link capacitors in the general technical data for the devices. You can only determine the absence of voltage after this time period.

Opening the housing, plugging in or unplugging connection terminals, connecting or removing a connecting wiring, and installing or removing accessories are prohibited while the voltage supply is switched on.

Protect the devices against falling parts (bits or strands of wire, pieces of metal, etc.) during installation or other work in the control cabinet. Parts with conductive properties may result in a short circuit inside the devices and device failure as a result.

Use only copper conductors. For the corresponding conductor cross-sections, consult the standards DIN VDE 0298-4 or EN 60204-1 (Annexes D, G) as well as the relevant terminal specifications in this documentation.

The protection class of the devices is protective grounding (protection class I in accordance with EN 61140). This means that operation is permitted only if the grounding conductor is connected according to requirements.

All protective ground connections are identified by "PE" or the international grounding symbol (IEC 60417, symbol 5019).

The products are not designed for use in a public low-voltage network that supplies residential areas. Radio-frequency interference can be expected if the products are used in this type of network.

## 11.2 Line routing

Observe the valid provisions for your machine or system, e.g. IEC 60364 or EN 50110, during the installation of electrical equipment.

## 11.3 Protective measures

Take the following protective measures into account.

### 11.3.1 Power grid supply with DC link connection

In a DC link connection, only operate drive controllers with the same supply voltage.

#### ATTENTION!

#### Damage to device when connecting 1-phase and 3-phase drive controllers!

Connecting 1-phase and 3-phase drive controllers will damage the 1-phase drive controllers.

- Only connect 1-phase or 3-phase drive controllers to drive controllers of the same type.

Also note the following:

- All 1-phase drive controllers must be connected to the same line conductor
- All 3-phase drive controllers must be operated on the same supply grid

#### Group with drive controllers of size 3

Furthermore, the following framework conditions apply in a group with size 3 drive controllers:

- If a group consists of drive controllers in sizes 0, 1, 2 and 3, only those of size 3 may be connected to the grid; the remaining drive controllers may be supplied only with DC voltage
- You may connect a maximum of two drive controllers of size 3
- A TEP4010-2US00 power choke must be upstream of each size 3 drive controller connected to the grid

#### ATTENTION!

#### Damage to device due to the emission of electromagnetic interference!

If the EMC threshold limits are exceeded during the operation of a DC link connection, devices in the immediate area can be interrupted or damaged.

- Take suitable measures to comply with the electromagnetic compatibility.
- Always route the shortest possible connections for DC links. If they are longer than 30 cm, they must be shielded.

#### ATTENTION!

#### Damage to device in case of drive controller failure!

The failure of a drive controller in the DC link can result in damage to additional drive controllers.

- A failure must trigger the isolation of the entire DC link group from the grid.

#### Wiring example

The example in the appendix (see [DC link connection \[▶ 438\]](#)) illustrates the basic connection of multiple SD6 drive controllers based on a DC link connection with a DL6A Quick DC-Link.



## 11.3.2 Line fuse

The drive controller is designed exclusively for operation in TN networks or on wye sources. At a nominal voltage of 200 to 480 V<sub>AC</sub>, they are permitted to supply a maximum differential short-circuit current in accordance with the following table:

Size	Max. differential short-circuit current
Size 0 – size 2	5000 A
Size 3	10000 A

Tab. 123: Maximum differential short-circuit current

The line fuse ensures the line and overload protection in the drive controller. To that end, observe the requirements described below, which vary based on the configuration.

### 11.3.2.1 Line fuses in stand-alone operation

You can use the following protective devices when operating a single drive controller:

- Full-range safety fuses for cable and line protection with operating class gG in accordance with IEC 60269-2-1 or time delay triggering characteristics in accordance with DIN VDE 0636
- Miniature circuit breakers with triggering characteristic C in accordance with EN 60898
- Circuit breakers

#### Information

For size 3 device types, only operation with power chokes and line fuses is permitted for operating class gG.

Information on the recommended maximum line fuse can be found in the following table:

Size	Type	$I_{1N,PU}$ (4 kHz) [A]	Recommended max. line fuse [A]
0	SD6A02	8.3	10
	SD6A04	2.8	10
	SD6A06	5.4	10
1	SD6A14	12	16
	SD6A16	19.2	20
2	SD6A24	26.4	35
	SD6A26	38.4	50
3	SD6A34	45.3	50
	SD6A36	76	80
	SD6A38	76	80

Tab. 124: Line fuses in stand-alone operation

#### Information

To ensure problem-free operation, always comply with the recommended trigger limits and trigger characteristics of the fuse elements.

### 11.3.2.2 Line fuses for DC link connection

Every drive controller connected to the grid in the DC link group must be protected at the line input against overload and short circuit. To do this, a fuse combination consisting of overload protection and semiconductor short-circuit protection is connected in series. A miniature circuit breaker protects against overload and a safety fuse with gR triggering characteristics protects against short circuit.

You can use the following fuse combinations:

Size	Type	$I_{1N,PU}$ (4 kHz) [A]	$I_{1maxPU}$ (4 kHz) [A]	Fuse selection	
				Miniature circuit breakers	Safety fuse
0	SD6A02	8.3	14.9	EATON Type: FAZ-B10/1, Manufacturer No. 278531 Triggering characteristics: B 10 A	SIBA Type: URZ, Item No. 50 140 06.20 Triggering characteristics: gR 20 A
	SD6A04	2.8	5	EATON Type: FAZ-B6/3, Manufacturer No. 278841 Triggering characteristics: B 6 A	SIBA Type: URZ, Item No. 50 140 06.20 Triggering characteristics: gR 20 A
	SD6A06	5.4	9.7		
1	SD6A14	12	21.6	EATON Type: FAZ-Z20/3, Manufacturer No. 278928 Triggering characteristics: Z 20 A	SIBA Type: URZ, Item No. 50 140 06.32 Triggering characteristics: gR 32 A
	SD6A16	19.2	34.6		
2	SD6A24	26.4	47.5	EATON Type: FAZ-Z40/3, Manufacturer No. 278931 Triggering characteristics: Z 40 A	SIBA Type: URZ, Item No. 50 140 06.80 Triggering characteristics: gR 80 A
	SD6A26	38.4	69.1		
3	SD6A34	45.3	81.5	EATON Type: FAZ-B63/3, Manufacturer No. 278853 Triggering characteristics: B 63 A <sup>12</sup>  Siemens Type: SIRUS, Item No. 3RV 1041-4KA10 Triggering characteristics: 57 A–75 A <sup>13</sup>	SIBA Type: URZ, Item No. 50 140 06.100 Triggering characteristics: gR 100 A
	SD6A36	76	136.8		
	SD6A38	76	136.8		

Tab. 125: Line fuses for DC link connection

<b>Information</b>
--------------------

To ensure problem-free operation, always comply with the recommended trigger limits and trigger characteristics of the fuse elements.

<sup>12</sup> The input current is reduced from 73 A to 63 A and the output power is lowered as a result; however, reliable rectifier protection is still guaranteed.

<sup>13</sup> Miniature circuit breaker size S3, CLASS 10, adjustable current range: 57 A – 75 A, electromagnetic triggering: 975 A. The rectifier diodes are not protected in the range of 2x to 13x the nominal current.

### Maximum number of drive controllers

Multiple drive controllers of the same rating can be connected via a common fuse combination. The fuses and the resulting maximum line input current correspond to that of a single drive controller.

In order to prevent gradual damage to the safety fuse, the maximum number of possible drive controllers on one fuse combination is limited as follows:

- Size 0: Maximum of 4 drive controllers
- Size 1: Maximum 2 drive controllers
- Size 2: Maximum 5 drive controllers
- Size 3: Maximum of 2 drive controllers

---

### ATTENTION!

#### Damage due to overload!

In order to ensure an even distribution of charging current on all AC-supplied drive controllers, all circuit breakers must be closed when engaging the power supply.

- In order that the input rectifier is not overloaded in the event of a possible fuse failure in the group, evaluation of the grid monitoring for AC-supplied drive controllers must lead to deactivation of the entire DC link group.
-

### 11.3.2.3 UL-compliant line fuses

For UL-compliance, use the following fuses for the powered drive controller:

- Fuses of class RK1 (e.g. Bussmann KTS-R-xxA/600 V), CF, J, T or G
- For drive controllers of sizes 0 and 1, you can alternatively use fuses of class CC
- For drive controllers of sizes 0 to 2, you can alternatively use type E motor starters, which consist of a circuit breaker and supply terminal

More detailed specifications about the appropriate fuses can be found in the following table:

Size	Type	Class CC [A]	Class RK1, CF, J, T or G [A]	Type E motor starter
0	SD6A02	10	10	EATON PKZM0-10/SP + BK25/3-PKZ0-E
	SD6A04	10	10	EATON PKZM0-10/SP + BK25/3-PKZ0-E
	SD6A06	10	10	EATON PKZM0-10/SP + BK25/3-PKZ0-E
1	SD6A14	15	15	EATON PKZM0-16/SP + BK25/3-PKZ0-E
	SD6A16	20	20	EATON PKZM0-25/SP + BK25/3-PKZ0-E
2	SD6A24	—	35	EATON PKZM0-32/SP + BK25/3-PKZ0-E
	SD6A26	—	50	EATON PKZM4-50 + BK50/3-PKZ4-E
3	SD6A34	—	50	—
	SD6A36	—	80	—
	SD6A38	—	80	—

Tab. 126: UL-compliant line fuses

The pre-configured Type E motor starters can be assembled as an alternative from the individual components in accordance with the following table:

Type E motor starter	Circuit breakers		Supply terminal		Lockable knob	
	Type	Item No.	Type	Item No.	Type	Item No.
PKZM0-10/SP + BK25/3-PKZ0-E	PKZM0-10	72739	BK25/3-PKZ0-E	262518	AK-PKZ0	30851
PKZM0-16/SP + BK25/3-PKZ0-E	PKZM0-16	46938				
PKZM0-25/SP + BK25/3-PKZ0-E	PKZM0-25	46989				
PKZM0-32/SP + BK25/3-PKZ0-E	PKZM0-32	278489				
PKZM4-50 + BK50/3-PKZ4-E	PKZM4-50	222355	BK50/3-PKZ4-E	272165		

Tab. 127: Individual components of Type E motor starters

<b>Information</b>
--------------------

To ensure problem-free operation, always comply with the recommended trigger limits and trigger characteristics of the fuse elements.

### 11.3.3 Grid connection for DC link connection

All drive controllers must be connected to the power grid simultaneously. Simultaneously in this case means that the time difference may be a maximum of 20 ms. This condition is generally met if you use contactors of identical design from one manufacturer.

Provided that simultaneous connection to the grid is achieved, the design with one contactor per drive controller is also permitted.

#### ATTENTION!

##### Damage due to overload!

If the grid does not connect to all drive controllers simultaneously in the design with one contactor per drive controller, their charging resistors can be damaged.

### 11.3.4 Residual current protective device

Depending on the function, leakage currents may occur when operating drive controllers. Leakage currents are interpreted as residual currents by residual current protective devices (RCDs) and may therefore lead to false triggering. Depending on the relevant power supply connections, residual currents may occur with or without a DC current component. Because of this, you should take into consideration both the magnitude as well as the profile of the possible leakage or residual current when selecting a suitable residual current protective device.

Leakage and residual currents with a DC current component can restrict the functionality of type A and AC residual current protective devices.

Protect 1-phase installations using type B universal current-sensitive residual current protective devices or type F mixed frequency-sensitive devices.

Protect 3-phase installations with type B universal current-sensitive residual current protective devices.

#### DANGER!

##### Electrical voltage! Risk of fatal injury due to electric shock!

In 3-phase installations, this product can cause a direct current in the protective grounding conductor.

- If a residual current protective device (RCD) or residual current monitoring device (RCM) is used for protection in case of direct or indirect contact, only one RCD or RCM of type B is permitted on the power supply side of this product.

##### False triggering – Causes

Depending on stray capacitances and imbalances, leakage currents above 30 mA may occur during operation.

Undesirable false triggering occurs under the following conditions:

- Connecting the installation to the supply voltage:  
This false triggering can be remedied by using short-time delayed (super-resistant), delayed switch-off (selective) residual current protective devices or those with increased tripping current (e.g. 300 or 500 mA).
- Higher frequency leakage currents for long power cables under normal operating conditions:  
For example, use low-capacitance cables or use an output choke.
- High imbalances in the supply grid.  
This false triggering can be rectified, e.g. using an isolating transformer.



**Electrical voltage! Risk of fatal injury due to electric shock!**

Residual current protective devices with increased tripping current as well as with short-time delayed or delayed switch-off trigger characteristics may not meet the requirements for personal protection.

- Check whether the use of the selected residual current protective device is permitted in your application.

### 11.3.5 Protective grounding

In order to dimension the grounding, it must be ensured that the upstream fuse is triggered in the event of a short circuit. Observe the requirements described below for the correct connection of the protective grounding.

#### 11.3.5.1 Minimum cross-section of the grounding conductor

Leakage currents > 10 mA can arise in normal operation. The minimum cross-section of the protective grounding conductor must comply with the local safety regulations for protective grounding conductors with high leakage current. To fulfill regulations such as EN 60204-1, connect a copper conductor according to the following table:

Cross-section A Power grid line	Minimum cross-section $A_{min}$ Grounding conductor
$A \leq 2.5 \text{ mm}^2$	2.5 mm <sup>2</sup>
$2.5 \text{ mm}^2 < A \leq 16 \text{ mm}^2$	A
$16 \text{ mm}^2 < A \leq 35 \text{ mm}^2$	$\geq 16 \text{ mm}^2$
$> 35 \text{ mm}^2$	A/2

Tab. 128: Minimum cross-section of the grounding conductor

#### 11.3.5.2 Cable shields and sheaths

In accordance with DIN EN 60204-1, the following parts of a machine and its electrical equipment must be connected to the grounding conductor system, but must not be used as grounding conductors:

- Metal cable shields
- Sheath

### 11.3.5.3 Connection of the grounding conductor

You connect the grounding conductor to the drive controller over terminal X10.

Additional requirements for protective equipotential bonding apply in the event of ground leakage currents > 10 mA. At least one of the following conditions must be fulfilled:

- The grounding conductor must have a minimum cross-section of 10 mm<sup>2</sup> Cu over its overall length
- If the grounding conductor has a cross-section of less than 10 mm<sup>2</sup>, a 2nd grounding conductor must be provided with a cross-section of at least the same size, as at terminal X10, up to the point at which the grounding conductor exhibits the minimum cross-section of 10 mm<sup>2</sup>

A ground bolt is mounted to the devices for connecting the 2nd grounding conductor. The ground bolt is marked with the grounding symbol according to IEC 60417 (symbol 5019).

You will need an open-ended wrench or external hex key with a width across flats of 10 mm.

Obey a tightening torque of 4.0 Nm (35 Lb.inch).

Observe the order for assembly:

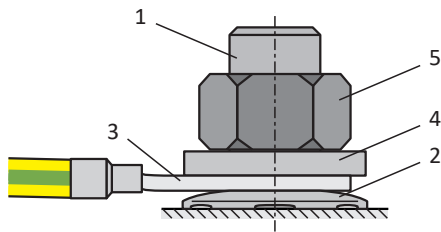

Fig. 33: Connection of the grounding conductor

- 1 M6 ground bolt
- 2 Contact disk
- 3 Cable lug
- 4 Washer
- 5 Nut

The contact disk, washer and nut are supplied with the drive controller.

### 11.3.6 EMC recommendations

#### Information

The following information on EMC-compliant installation is only a recommendation. Depending on the application, the ambient conditions as well as the legal requirements, measures beyond these recommendations may be required.

Lay the power line, power cable and signal lines separately from each other, e.g. in separate cable ducts.

Only use shielded, low-capacitance cables as power cables.

If the brake line is carried in the power cable, it must be shielded separately.

Ground and insulate free line ends if they cannot be connected to the terminals provided for this purpose on the drive controller, e.g. using a connecting terminal.

Connect the shield of the power cable to the grounding conductor system over a wide area and in the immediate vicinity of the drive controller. For this purpose, use the shield contact provided for the drive controllers or suitable accessories.

The connection lines for braking resistors as well as the cores of the Quick DC-Link modules must be implemented as twisted pairs. At line lengths of 30 cm or more, the lines also must be implemented with shielding and the shield must be applied over a wide area in the immediate vicinity of the drive controller.

For motors with terminal boxes, connect the shield to the terminal box over large contact areas. For example, use EMC cable screw connections.

Connect the shield of the control lines on one side to the reference potential of the source, e.g. the PLC or CNC.

You may use chokes to improve the EMC and protect the drive system. Power chokes are used to dampen voltage and current peaks and reduce the load of the power feed-in of the drive controllers or supply modules. Output chokes reduce current peaks caused by line capacity at the power output of the drive controller.

## 11.4 Drive controllers

The following section contains detailed information about the terminals and the correct connection of the drive controller.

#### Information

For UL-compliant operation: The connections marked with PE are intended solely for the functional grounding.

### 11.4.1 Overview with ST6 safety module

The images for the connection overviews show the SD6 drive controller in every size with the following equipment:

- ST6 safety module (STO using terminals)
- XI6 terminal module
- EC6 communication module (EtherCAT)

Alternatively, the following equipment is available:

- RI6 or IO6 terminal modules
- CA6 (CANopen) or PN6 (PROFINET) communication modules



11.4.1.1 Sizes 0 and 1

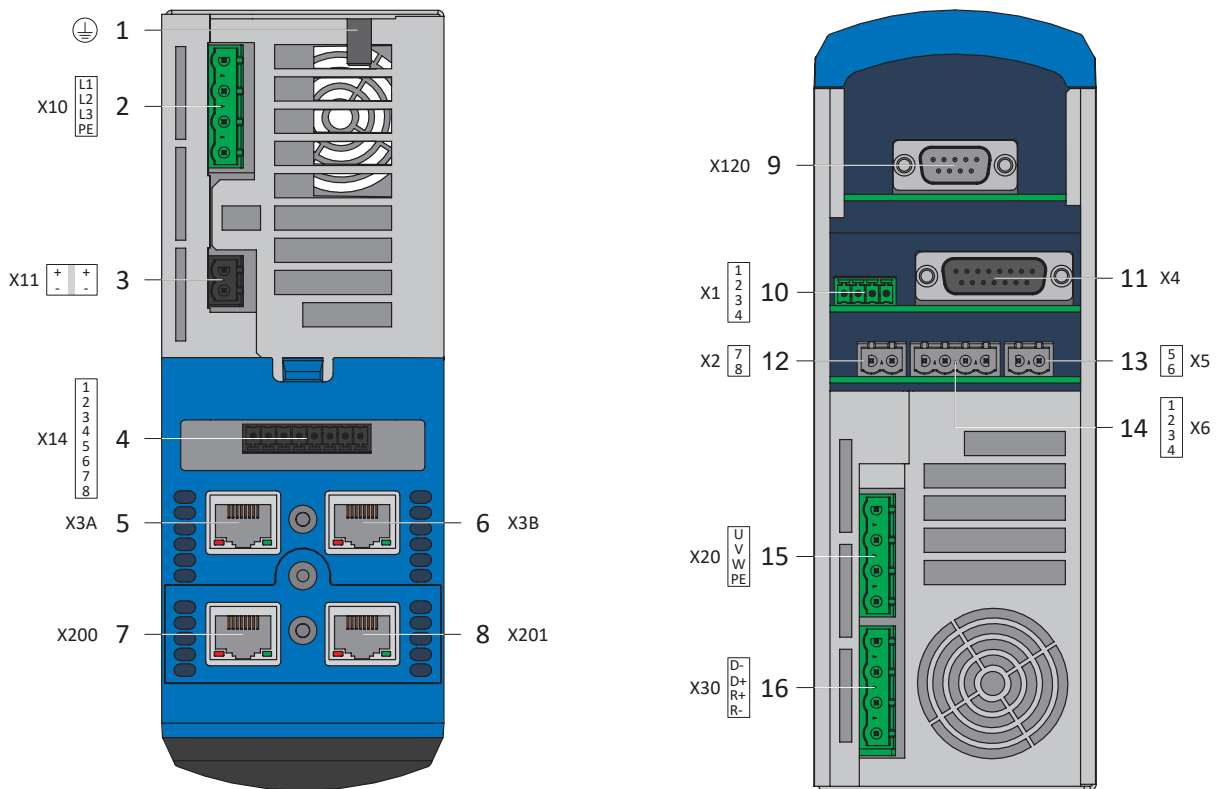

Fig. 34: Connection overview of sizes 0 and 1 with ST6 safety module

- |  |   |
|--|---|
| <p>1 Ground bolt</p> <p>2 X10: 230/400 V<sub>AC</sub> supply</p> <p>3 X11: 24 V<sub>DC</sub> supply</p> <p>4 X12: ST6 safety technology</p> <p>5 X3A: PC, IGB</p> <p>6 X3B: PC, IGB</p> <p>7 X200: EtherCAT on the optional EC6 communication module (alternatively CANopen on CA6 communication module or PROFINET on PN6 communication module)</p> <p>8 X201: EtherCAT on the optional EC6 communication module (alternatively PROFINET on PN6 communication module)</p> | <p>9 X120: Encoder connection on optional X16 terminal module (alternatively X120 and X140: Encoder connections on RI6 terminal module or IO6 terminal module without encoder connection)</p> <p>10 X1: Enable and relay 1</p> <p>11 X4: Encoder</p> <p>12 X2: Motor temperature sensor</p> <p>13 X5: Brake (actuation)</p> <p>14 X6: Brake (feedback and supply)</p> <p>15 X20: Motor</p> <p>16 X30: Quick DC-Link, braking resistor</p> |
|--|---|

11.4.1.2 Size 2

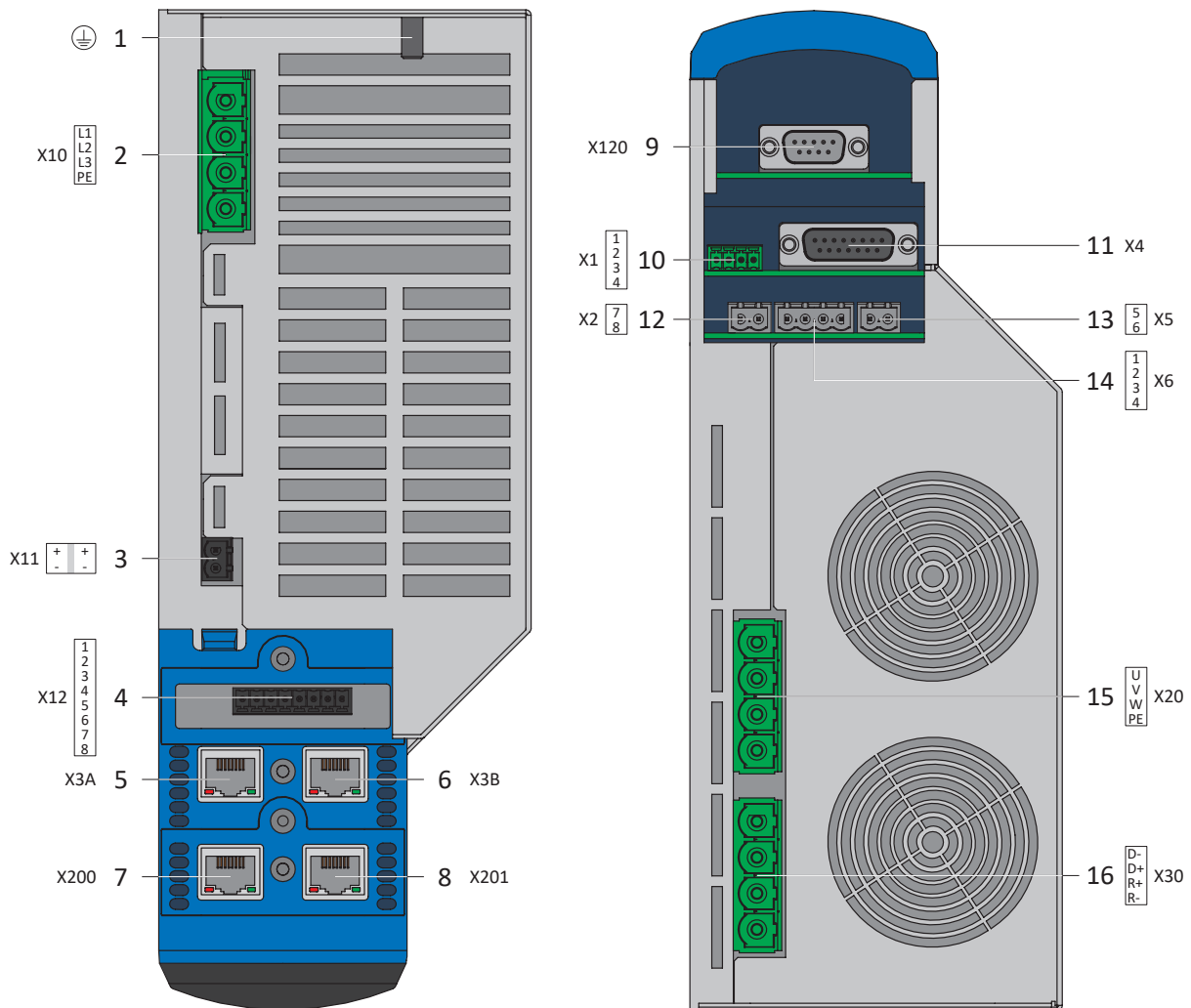

Fig. 35: Connection overview of size 2 with ST6 safety module

- |  |   |
|--|---|
| <p>1 Ground bolt</p> <p>2 X10: 400 V<sub>AC</sub> supply</p> <p>3 X11: 24 V<sub>DC</sub> supply</p> <p>4 X12: ST6 safety technology</p> <p>5 X3A: PC, IGB</p> <p>6 X3B: PC, IGB</p> <p>7 X200: EtherCAT on the optional EC6 communication module<br/>(alternatively CANopen on CA6 communication module or PROFINET on PN6 communication module)</p> <p>8 X201: EtherCAT on the optional EC6 communication module<br/>(alternatively PROFINET on PN6 communication module)</p> | <p>9 X120: Encoder connection on optional X16 terminal module (alternatively X120 and X140: Encoder connections on RI6 terminal module or IO6 terminal module without encoder connection)</p> <p>10 X1: Enable and relay 1</p> <p>11 X4: Encoder</p> <p>12 X2: Motor temperature sensor</p> <p>13 X5: Brake (actuation)</p> <p>14 X6: Brake (feedback and supply)</p> <p>15 X20: Motor</p> <p>16 X30: Quick DC-Link, braking resistor</p> |
|--|---|

11.4.1.3 Size 3

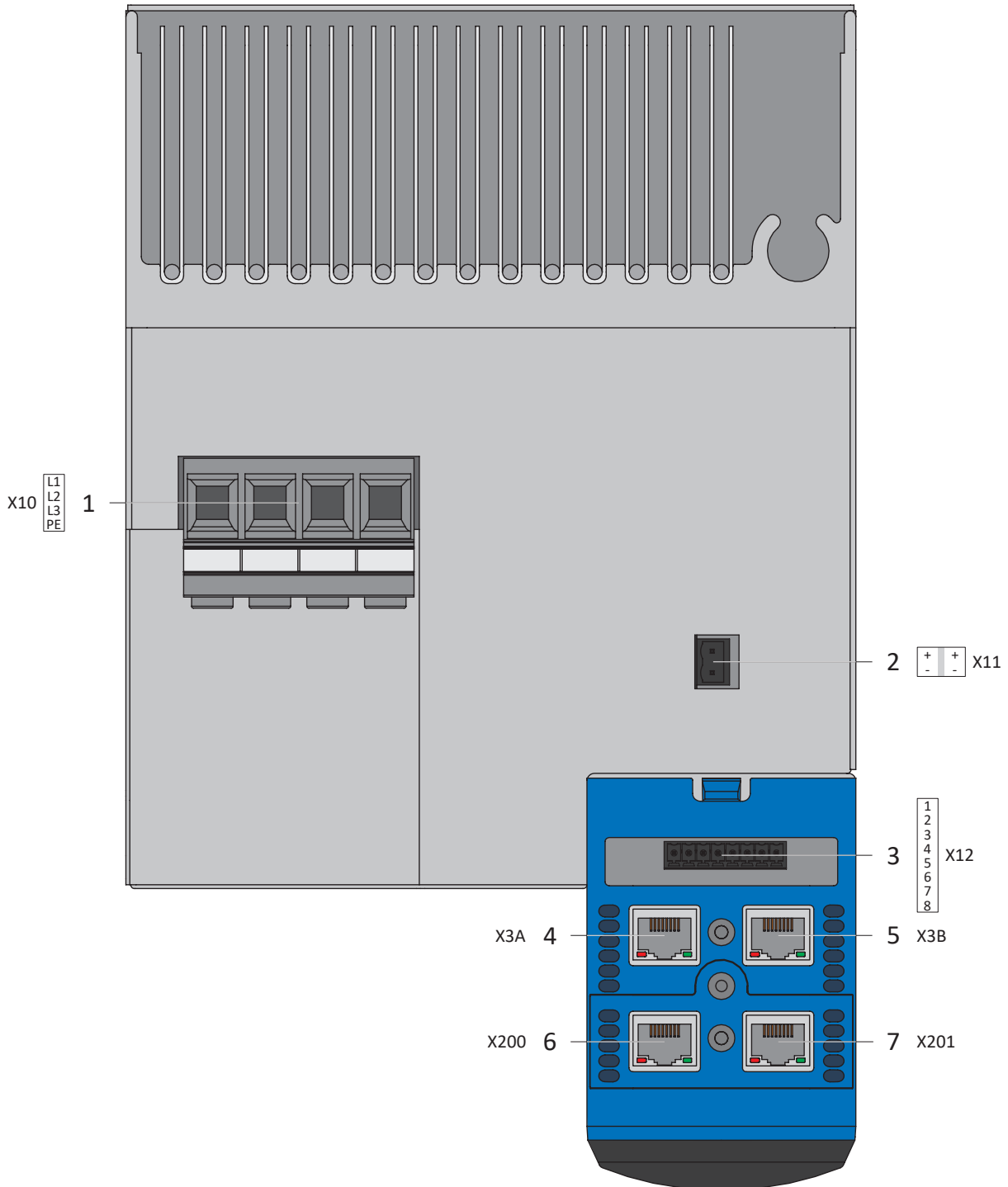

Fig. 36: Connection overview of size 3 with ST6 safety module, top of device

- 1 X10: 400 V<sub>AC</sub> supply
- 2 X11: 24 V<sub>DC</sub> supply
- 3 X12: ST6 safety technology
- 4 X3A: PC, IGB
- 5 X3B: PC, IGB
- 6 X200: EtherCAT on the optional EC6 communication module (alternatively CANopen on CA6 communication module or PROFINET on PN6 communication module)
- 7 X201: EtherCAT on the optional EC6 communication module (alternatively PROFINET on PN6 communication module)

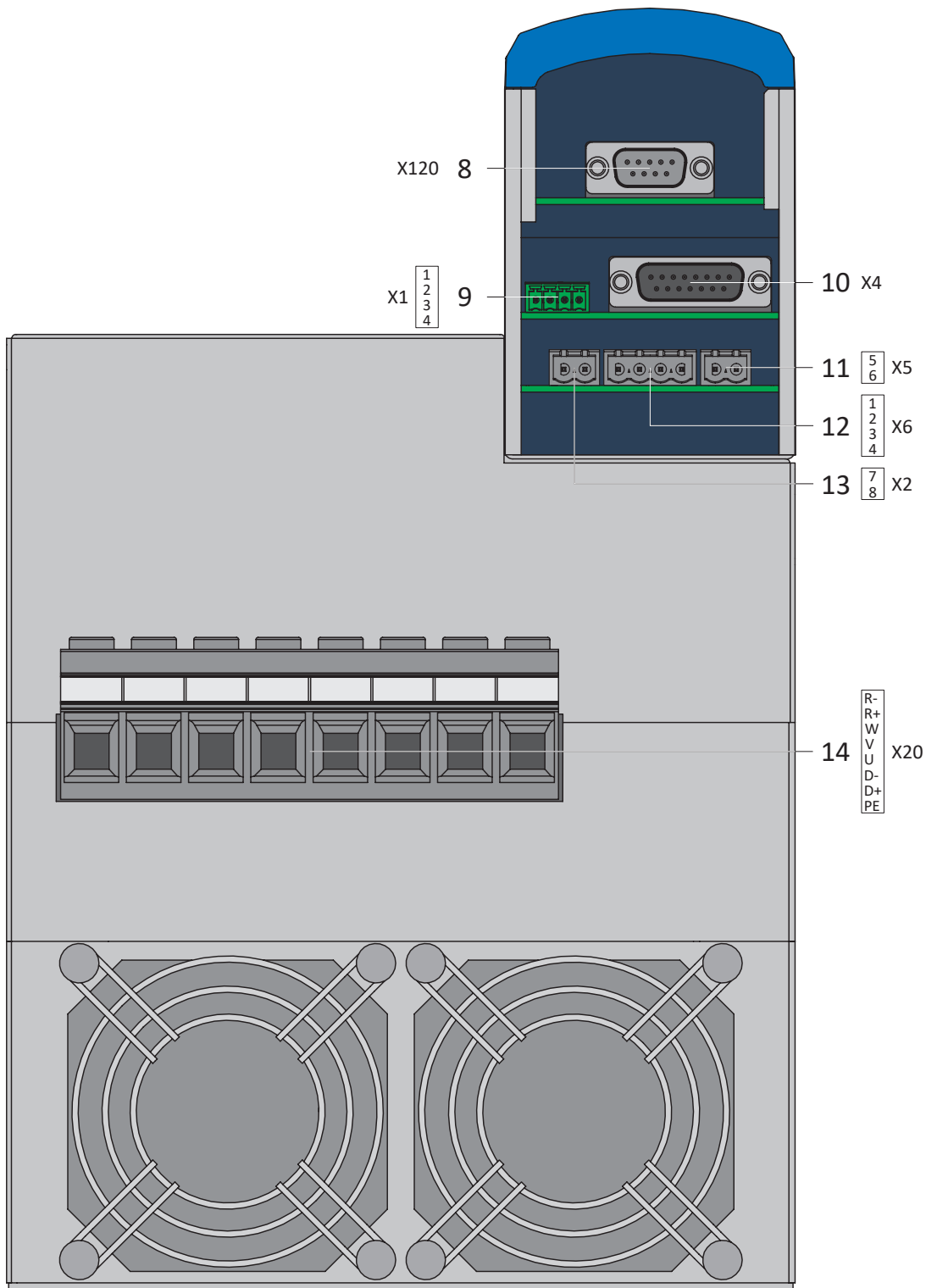

Fig. 37: Connection overview of size 3 with ST6 safety module, bottom of device

- 8 X120: Encoder connection on optional XI6 terminal module (alternatively X120 and X140: Encoder connections on RI6 terminal module or IO6 terminal module without encoder connection)
- 9 X1: Enable and relay 1
- 10 X4: Encoder
- 11 X5: Brake (actuation)
- 12 X6: Brake (feedback and supply)
- 13 X2: Motor temperature sensor
- 14 X20: Motor, Quick DC-Link, braking resistor

## 11.4.2 Overview with SE6 safety module

The images for the connection overviews show the SD6 drive controller in every size with the following equipment:

- SE6 safety module (expanded safety functionality via terminals)
- XI6 terminal module
- EC6 communication module (EtherCAT)

Alternatively, the following equipment is available:

- RI6 or IO6 terminal modules
- CA6 (CANopen) or PN6 (PROFINET) communication modules

11.4.2.1 Sizes 0 and 1

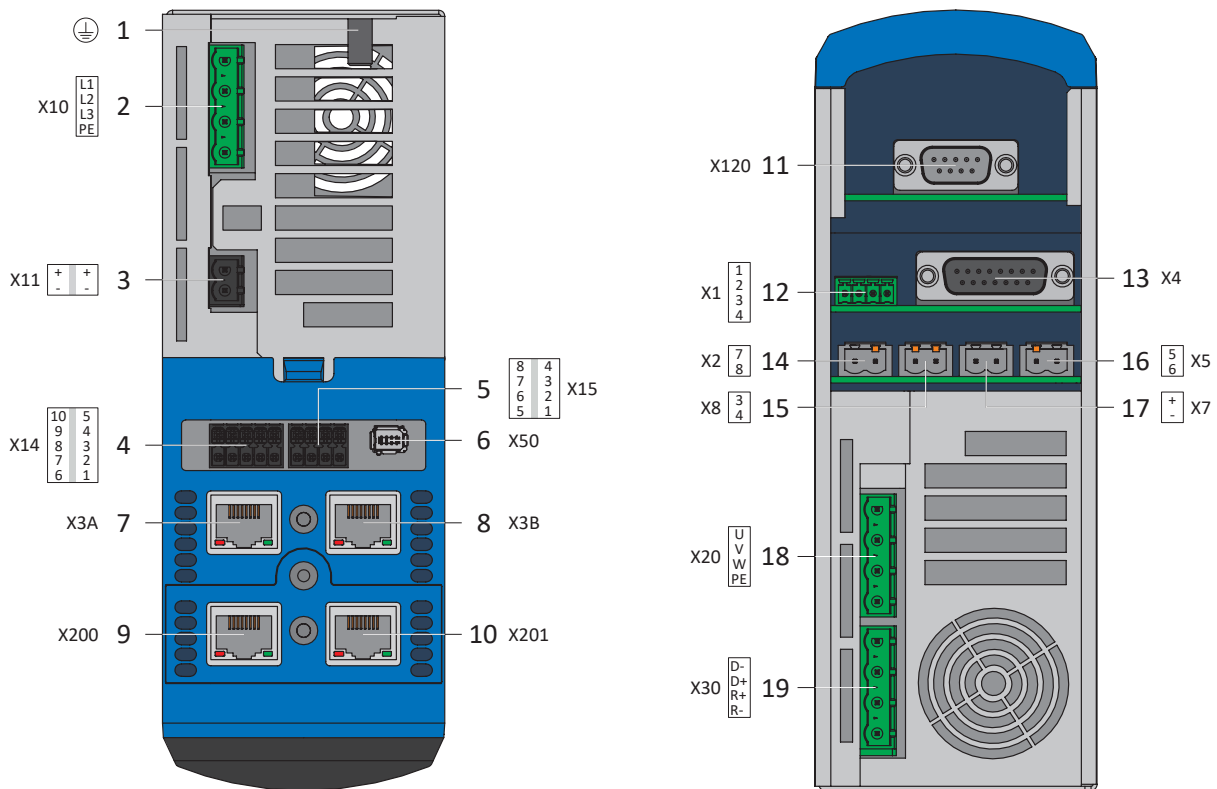

Fig. 38: Connection overview of sizes 0 and 1 with SE6 safety module

- |  |   |
|--|---|
| <p>1 Ground bolt</p> <p>2 X10: 230/400 V<sub>AC</sub> supply</p> <p>3 X11: 24 V<sub>DC</sub> supply</p> <p>4 X14: SE6 safety technology – Safe inputs</p> <p>5 X15: SE6 safety technology – Safe outputs and supply for X50</p> <p>6 X50: SE6 safety technology – Plausibility encoder</p> <p>7 X3A: PC, IGB</p> <p>8 X3B: PC, IGB</p> <p>9 X200: EtherCAT on the optional EC6 communication module (alternatively CANopen on CA6 communication module or PROFINET on PN6 communication module)</p> <p>10 X201: EtherCAT on the optional EC6 communication module (alternatively PROFINET on PN6 communication module)</p> | <p>11 X120: Encoder connection on optional X16 terminal module (alternatively X120 and X140: Encoder connections on RI6 terminal module or IO6 terminal module without encoder connection)</p> <p>12 X1: Enable and relay 1</p> <p>13 X4: Encoder</p> <p>14 X2: Motor temperature sensor</p> <p>15 X8: Brake 2 (SBC+/-)</p> <p>16 X5: Brake 1 (BD1/BD2)</p> <p>17 X7: Supply for brake(s)</p> <p>18 X20: Motor</p> <p>19 X30: Quick DC-Link, braking resistor</p> |
|--|---|

11.4.2.2 Size 2

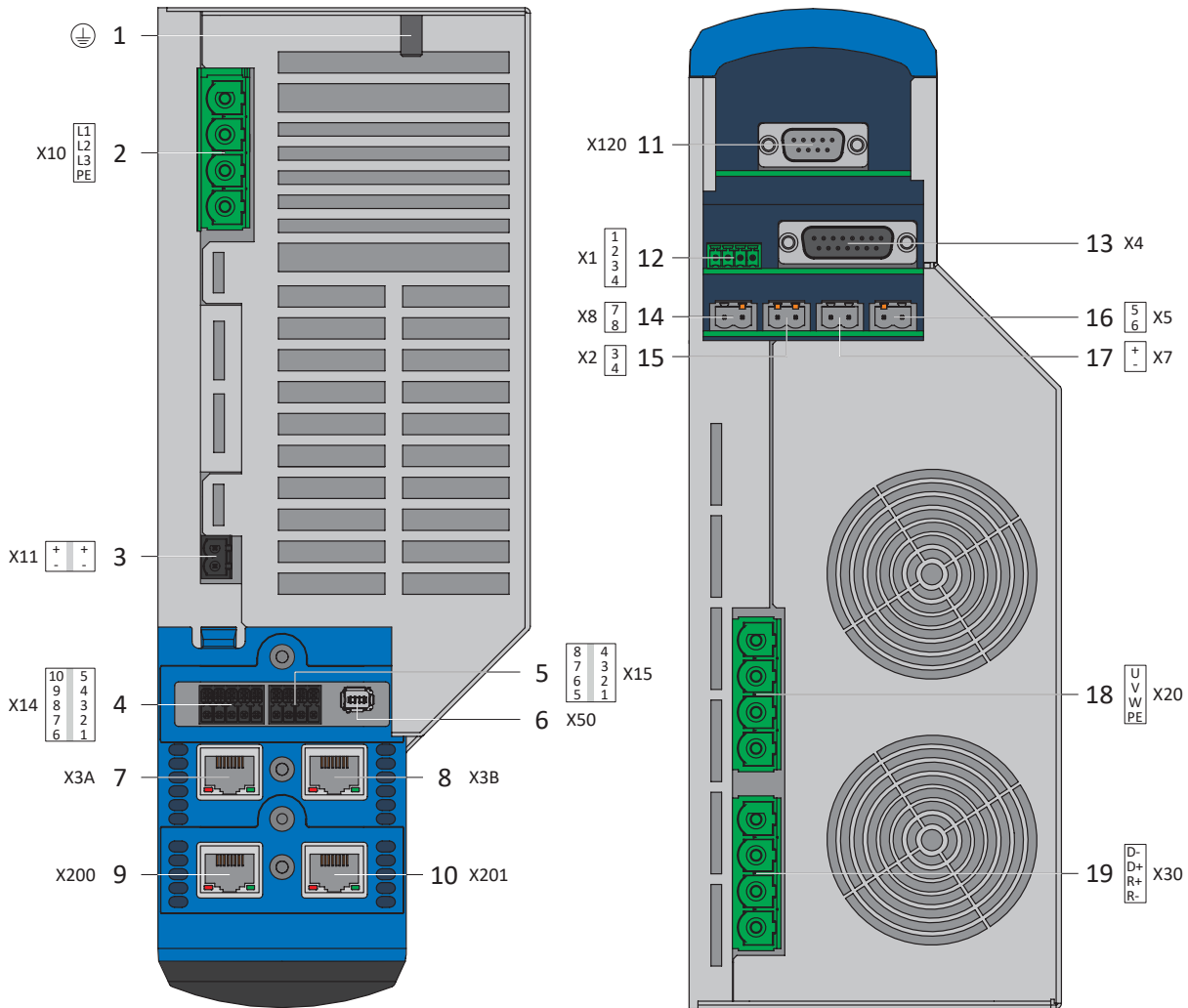

Fig. 39: Connection overview of size 2 with SE6 safety module

- |  |   |
|--|---|
| <p>1 Ground bolt</p> <p>2 X10: 230/400 V<sub>AC</sub> supply</p> <p>3 X11: 24 V<sub>DC</sub> supply</p> <p>4 X14: SE6 safety technology – Safe inputs</p> <p>5 X15: SE6 safety technology – Safe outputs and supply for X50</p> <p>6 X50: SE6 safety technology – Plausibility encoder</p> <p>7 X3A: PC, IGB</p> <p>8 X3B: PC, IGB</p> <p>9 X200: EtherCAT on the optional EC6 communication module (alternatively CANopen on CA6 communication module or PROFINET on PN6 communication module)</p> <p>10 X201: EtherCAT on the optional EC6 communication module (alternatively PROFINET on PN6 communication module)</p> | <p>11 X120: Encoder connection on optional XI6 terminal module (alternatively X120 and X140: Encoder connections on RI6 terminal module or IO6 terminal module without encoder connection)</p> <p>12 X1: Enable and relay 1</p> <p>13 X4: Encoder</p> <p>14 X2: Motor temperature sensor</p> <p>15 X8: Brake 2 (SBC+/-)</p> <p>16 X5: Brake 1 (BD1/BD2)</p> <p>17 X7: Supply for brake(s)</p> <p>18 X20: Motor</p> <p>19 X30: Quick DC-Link, braking resistor</p> |
|--|---|

11.4.2.3 Size 3

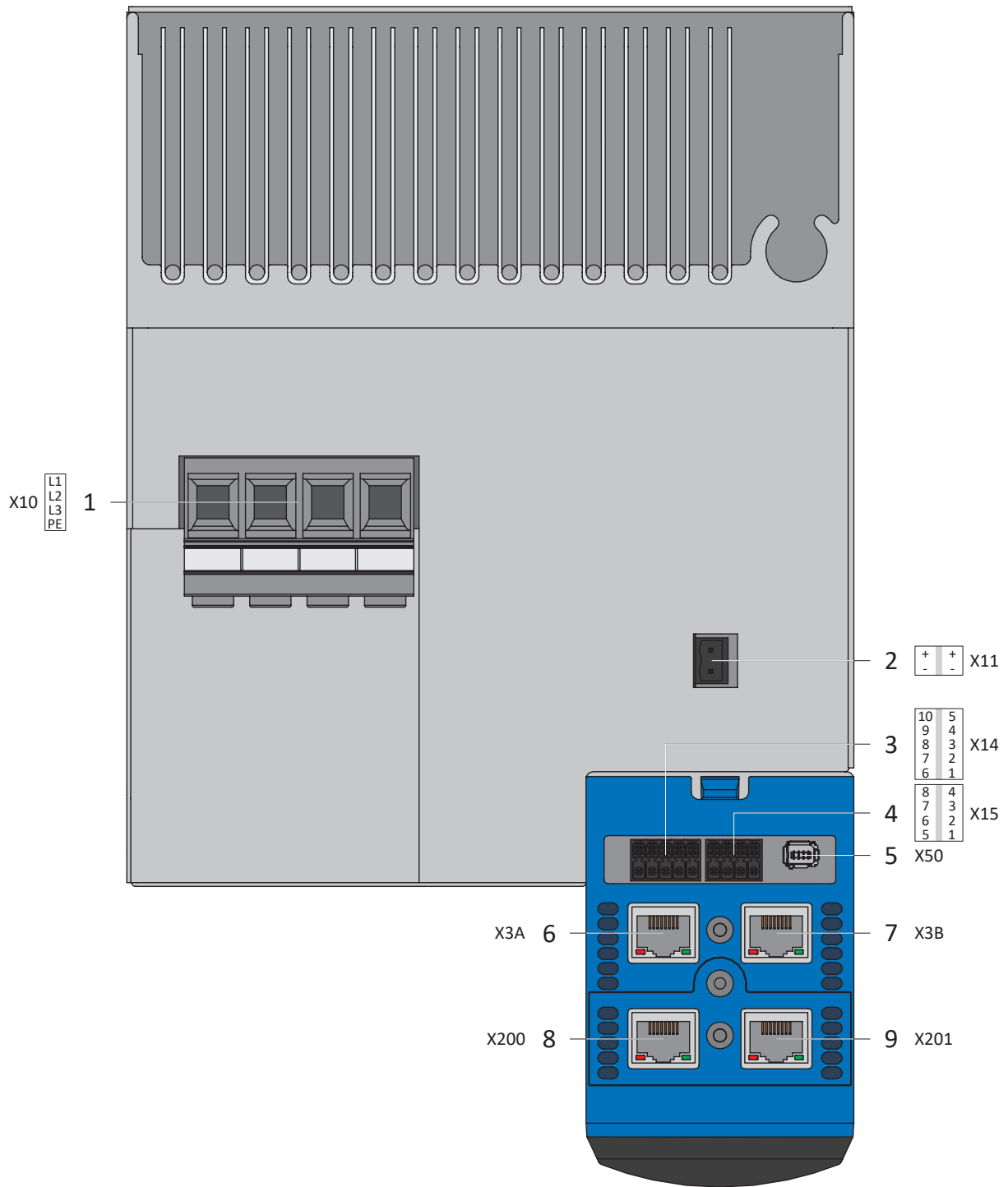

Fig. 40: Connection overview of size 3 with SE6 safety module, top of device



- 1 X10: 400 V<sub>AC</sub> supply
- 2 X11: 24 V<sub>DC</sub> supply
- 3 X14: SE6 safety technology – Safe inputs
- 4 X15: SE6 safety technology – Safe outputs and supply for X50
- 5 X50: SE6 safety technology – Plausibility encoder
- 6 X3A: PC, IGB
- 7 X3B: PC, IGB
- 8 X200: EtherCAT on the optional EC6 communication module  
(alternatively CANopen on CA6 communication module or  
PROFINET on PN6 communication module)
- 9 X201: EtherCAT on the optional EC6 communication module  
(alternatively PROFINET on PN6 communication module)

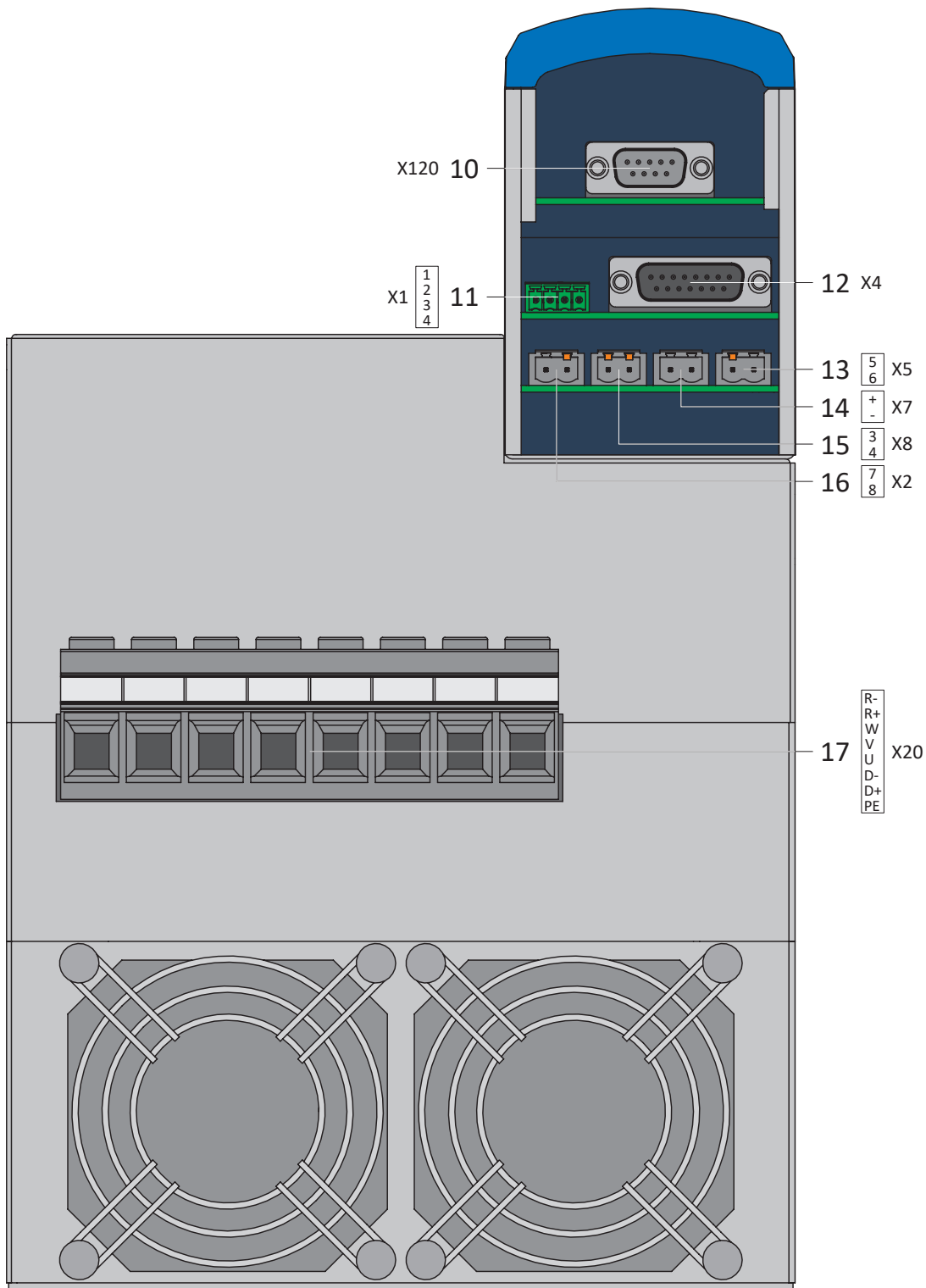

Fig. 41: Connection overview of size 3 with SE6 safety module, bottom of device

- 10 X120: Encoder connection on optional XI6 terminal module (alternatively X120 and X140: Encoder connections on RI6 terminal module or IO6 terminal module without encoder connection)
- 11 X1: Enable and relay 1
- 12 X4: Encoder
- 13 X5: Brake 1 (BD1/BD2)
- 14 X7: Supply for brake(s)
- 15 X8: Brake 2 (SBC+/-)
- 16 X2: Motor temperature sensor
- 17 X20: Motor, Quick DC-Link, braking resistor

### 11.4.3 X1: Enable and relay 1

You enable the power unit of the drive controller using the enable signal. The function of relay 1 can be parameterized using parameter F75.

#### Technical data

Note the technical data for X1 (see [Enable and relay](#) [▶ 48]).

Terminal	Pin	Designation	Function
 1   2   3   4	1	NO contact	Relay 1; recommended fuse protection: max. 1 A <sup>14</sup>
	2		
	3	0 V GND	Enable
	4	Input	

Tab. 129: X1 connection description

#### Connecting wiring

For the connecting wiring, obey the terminal specification [FMC 1,5 -ST-3,5](#) [▶ 431].

#### Cable requirements

Feature	All sizes
Max. cable length	30 m

Tab. 130: Cable length [m]

<sup>14</sup> For fuse protection, use a 1 A fuse (time delay) before relay 1. For UL-compliant use, be sure that the fuse meets certification requirements for DC voltage in accordance with UL 248.

### 11.4.4 X2: Motor temperature sensor

Terminal X2 is provided for connecting motor temperature sensors. The following can be connected to all SD6 drive controller device types:

- A KTY84-130 in one winding
- A Pt1000 in one winding
- A PTC triplet

<b>Information</b>
--------------------

Evaluation of the temperature sensor is always active. If operation without a temperature sensor is permitted, the connections must be bridged to X2. Otherwise a fault is triggered when the device is switched on.

<b>Information</b>
--------------------

STOBER recommends the use of PTC thermistors as thermal winding protection.

#### Motor temperature sensor wires in the resolver or EnDat cable for SDS 4000

If you replace an SDS 4000 with an SD6, the wires of the motor temperature sensor are maintained in the previously used encoder cable. To be able to continue using the cable, you need the RI6 terminal module, to which you can connect the cable via an AP6 interface adapter. The adapter is available in three different designs.

#### Connection description

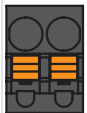
	Pin	Designation	Function
 7   8	7	1TP1/1K1	PTC/Pt1000/KTY connection
	8	1TP2/1K2	

Tab. 131: X2 connection description

#### Connecting wiring

For the connecting wiring, obey the terminal specification [BFL 5.08HC 180 SN \[▶ 428\]](#).

#### Cable requirements

Feature	All sizes
Max. cable length	100 m

Tab. 132: Cable length [m]

### 11.4.5 X3A, X3B: PC, IGB

You can implement the IGB function (Integrated Bus) using the X3A and X3B interfaces:

- Direct connection to the PC
- IGB motion bus
- Remote maintenance

Socket	Pin	Designation	Function
1 2  ...  7 8 	1	Tx+	Ethernet communication
	2	Tx-	
	3	Rx+	
	4	—	—
	5	—	—
	6	Rx-	Ethernet communication
	7	—	—
	8	—	—

Tab. 133: X3A and X3B connection description

#### Cable requirements

##### Information

To ensure proper functionality, we recommend using cables from STOBER that are matched to the complete system. If unsuitable cables are used, we reserve the right to reject claims under the warranty.

STOBER offers ready-made cables for:

- Direct connection of PC and drive controller
- Setup of Integrated Bus

It is also possible to use cables with the following specification:

Ethernet patch cables or crossover cables meeting the CAT 5e quality level are the ideal cables. The Fast Ethernet technology allows a maximum cable length of 100 m between two nodes.

##### Information

Ensure that you only use shielded cables with an SF/FTP, S/FTP or SF/UTP design.

#### Device addressing

For information on device addressing, see [Device addressing \[▶ 439\]](#).

### 11.4.6 X4: Encoder

The encoders described below can be connected to X4.

**ATTENTION!**

**Risk of encoder destruction!**

X4 may not be plugged in or unplugged when the device is switched on!

**Evaluable encoders**

Note the technical data of the evaluable encoders at X4 (see [X4 \[▶ 64\]](#)).

**EnDat 2.1/2.2 digital encoders and SSI encoders**

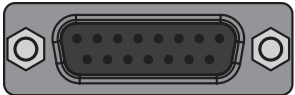
Socket	Pin	Designation	Function
	8 7 6 5 4 3 2 1	1	—
	2	0 V GND	Reference potential for encoder supply to pin 4
	3	—	—
	4	U <sub>2</sub>	Encoder supply
	5	Data +	Differential input for DATA
	6	—	—
	7	—	—
	8	Clock +	Differential input for CLOCK
	9	—	—
	10	0 V Sense	Optional reference potential of the Sense connection for regulating the encoder supply
	11	—	—
	12	U <sub>2</sub> Sense	Sense connection for regulating the encoder supply
	13	Data -	Inverse differential input for DATA
	14	—	—
	15	Clock -	Inverse differential input for CLOCK

Tab. 134: X4 connection description for EnDat 2.1/2.2 digital encoders and SSI encoders

**Differential HTL incremental encoders**

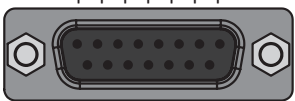
Socket	Pin	Designation	Function
	1	B +	Differential input for B channel
	2	0 V GND	Reference potential for encoder supply to pin 4
	3	N +	Differential input for N channel
	4	U <sub>2</sub>	Encoder supply
	5	—	—
	6	A +	Differential input for A channel
	7	—	—
	8	—	—
	9	B -	Inverse differential input for B channel
	10	N -	Inverse differential input for N channel
	11	A -	Inverse differential input for A channel
	12	U <sub>2</sub> Sense	Sense connection for regulating the encoder supply
	13	—	—
	14	—	—
	15	—	—

Tab. 135: X4 connection description for differential HTL incremental encoders

**Differential TTL incremental encoders**

Socket	Pin	Designation	Function
	1	—	—
	2	0 V GND	Reference potential for encoder supply to pin 4
	3	—	—
	4	U <sub>2</sub>	Encoder supply
	5	B +	Differential input for B channel
	6	—	—
	7	N +	Differential input for N channel
	8	A +	Differential input for A channel
	9	—	—
	10	—	—
	11	—	—
	12	U <sub>2</sub> Sense	Sense connection for regulating the encoder supply
	13	B -	Inverse differential input for B channel
	14	N -	Inverse differential input for N channel
	15	A -	Inverse differential input for A channel

Tab. 136: X4 connection description for differential TTL incremental encoders

**Cable requirements**

Feature	All sizes
Max. cable length	100 m, shielded

Tab. 137: Cable length [m]

**Information**

To ensure proper functionality, we recommend using cables from STOBER that are matched to the complete system. If unsuitable cables are used, we reserve the right to reject claims under the warranty.

### 11.4.7 X5: Brake – Actuation

The brake is connected to X5.

**Information**

Note that brakes from other manufacturers may be connected only after consultation with STOBER.

**Controllable brakes**

Note the technical data of the brakes controllable at X5 (see [X5 \[▶ 80\]](#)).

**Information**

In the parameters F93 and F100, you can set whether the brake is connected directly or indirectly and whether brake monitoring is deactivated.

	Pin	Designation	Function
 5   6	5	1BD1	Brake actuation
	6	1BD2	Reference potential

Tab. 138: X5 connection description

**Connecting wiring**

For the connecting wiring, obey the terminal specification [BFL 5.08HC 180 SN \[▶ 428\]](#).

**Cable requirements**

Feature	All sizes
Max. cable length	100 m

Tab. 139: Cable length [m]



## 11.4.8 X6: Brake – Feedback and supply (ST6 option)

X6 is used for brake diagnostics and supply. The X6 connection is part of the ST6 safety module.

Electrical data	All types
$U_1$	24 V <sub>DC</sub> +25%
$I_{1max}$	6 A, UL: 4 A

Tab. 140: Electrical data for the brake supply

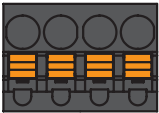
Terminal	Pin	Designation	Function
 1   2   3   4	1	Feedback	Feedback input of an optional switching amplifier for braking diagnostics; if the brake is connected to SD6 indirectly over a contactor and the switching amplifier is to be monitored, pins 1 and 2 must be connected via an external N/O contact
	2	0 V GND	Reference potential for feedback
	3	+	24 V <sub>DC</sub> supply for the brake; recommended fuse protection: max. 6 AT <sup>15</sup>
	4	-	Reference potential for supply voltage of the brake

Tab. 141: X6 connection description

### Connecting wiring

For the connecting wiring, obey the terminal specification [BFL 5.08HC 180 SN \[▶ 428\]](#).

### Cable requirements

Feature	All sizes
Max. cable length	30 m

Tab. 142: Cable length [m]

## 11.4.9 X7: Brake 2 – Supply (SE6 option)

X7 serves as the brake supply for brake 2. The X7 connection is part of the SE6 safety module.

Electrical data	All types
$U_1$	24 V <sub>DC</sub> +20%
$I_{1max}$	8 A, UL: 4 A

Tab. 143: Electrical data for the brake supply

<sup>15</sup> For UL-compliance, use of a 4 A fuse (time delay) is required. Be sure that the fuse meets certification requirements for DC voltage in accordance with UL 248.

	Pin	Designation	Function
 1   2	1	+	24 V <sub>DC</sub> supply for the brakes at X5 and X8; recommended fuse protection: max. 8 AT <sup>16</sup>
	2	-	Reference potential for supply voltage of the brakes

Tab. 144: X7 connection description

**Connecting wiring**

For the connecting wiring, obey the terminal specification [BFL 5.08HC 180 SN \[▶ 428\]](#).

**Cable requirements**

Feature	All sizes
Max. cable length	30 m

Tab. 145: Cable length [m]

**11.4.10 X8: Brake 2 – Safe brake control (SE6 option)**

X8 serves as the safe brake control for brake 2. The X8 connection is part of the SE6 safety module.

<b>Information</b>
<p>If you would like to use the expanded safety functionality via terminals, be sure to read the manual for the SE6 safety module (see <a href="#">Detailed information [▶ 476]</a>).</p>

**Controllable brakes**

Note the technical data of the brakes controllable at X8 (see [X8 \(option SE6\) \[▶ 80\]](#)).

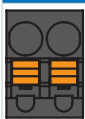
	Pin	Designation	Function
 3   4	3	SBC+	Output for brake control 2 +
	4	SBC-	Output for brake control 2 -

Tab. 146: X8 connection description

**Connecting wiring**

For the connecting wiring, obey the terminal specification [BFL 5.08HC 180 SN \[▶ 428\]](#).

**Cable requirements**

Feature	All sizes
Max. cable length	100 m; shielded on drive controllers of size 3

Tab. 147: Cable length [m]

<sup>16</sup> For UL-compliance, use of a 4 A fuse (time delay) is required. Note that the fuse meets certification requirements for the relevant DC voltage in accordance with UL 248.

### 11.4.11 X10: 230/400 V supply

Terminal X10 serves to connect the drive controller to the supply grid.

#### Conductor cross-sections for the power connection

When selecting the conductor cross-section, note the line fuse, the maximum permitted conductor cross-section of terminal X10, the routing method and the surrounding temperature.

#### Size 0

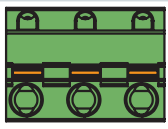
Terminal	Pin	Designation	Function
 1   2   3	1	L1	Power supply
	2	N	Neutral conductor
	3	PE	Grounding conductor

Tab. 148: X10 connection description – Size 0, 1-phase line connection

Terminal	Pin	Designation	Function
 1   2   3   4	1	L1	Power supply
	2	L2	
	3	L3	
	4	PE	Grounding conductor

Tab. 149: X10 connection description – Size 0, 3-phase line connection

For the connecting wiring, obey the terminal specification [GFKC 2,5 -ST-7,62 \[▶ 432\]](#).

#### Size 1

Terminal	Pin	Designation	Function
 1   2   3   4	1	L1	Power supply
	2	L2	
	3	L3	
	4	PE	Grounding conductor

Tab. 150: X10 connection description – Size 1, 3-phase line connection

For the connecting wiring, obey the terminal specification [SPC 5 -ST-7,62 \[▶ 434\]](#).

#### Size 2

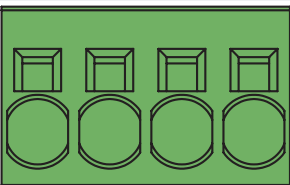
Terminal	Pin	Designation	Function
 1   2   3   4	1	L1	Power supply
	2	L2	
	3	L3	
	4	PE	Grounding conductor

Tab. 151: X10 connection description – Size 2, 3-phase line connection

For the connecting wiring, obey the terminal specification [SPC 16 -ST-10,16 \[▶ 435\]](#).

**Size 3**

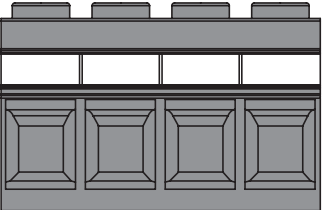
Terminal	Pin	Designation	Function
 <p>1   2   3   4</p>	1	L1	Power supply
	2	L2	
	3	L3	
	4	PE	Grounding conductor

Tab. 152: X10 connection description – Size 3, 3-phase line connection

For the connecting wiring, note the [MKDSP 25 -15,00 \[▶ 434\]](#) terminal specification.

### 11.4.12 X11: 24 V supply

The connection of 24 V<sub>DC</sub> to X11 is required for the power supply of the control unit.

**ATTENTION!**

**Device damage due to overload!**

If the 24 V<sub>DC</sub> power supply is looped to multiple devices over the terminal, the terminal may be damaged by a current that is too high.

- Make sure that the current over the terminal does not exceed the value 15 A (UL: 10 A).

Electrical data	All types
U <sub>1CU</sub>	24 V <sub>DC</sub> +20%/–15%
I <sub>1maxCU</sub>	1.5 A

Tab. 153: Control unit electrical data

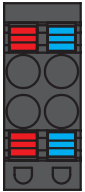
	Pin	Designation	Function
 <p>1   3</p> <p>2   4</p>	1	+	24 V <sub>DC</sub> supply for the control unit; bridged in the terminal; design in accordance with EN 60204: PELV, secondary grounded, recommended fuse protection: max. 15 A <sup>17</sup>
	2		
	3	–	Reference potential for +24 V <sub>DC</sub> , bridged in the terminal
	4		

Tab. 154: X11 connection description

**Information**

The device may not be connected to a DC supply grid. Instead, supply it over a local 24 V<sub>DC</sub> power supply unit.

<sup>17</sup> For UL-compliance, use of a 10 A fuse (time delay) is required. Be sure that the fuse meets certification requirements for DC voltage in accordance with UL 248.

### Connecting wiring

For the connecting wiring, obey the terminal specification [BLDF 5.08 180 SN \[► 429\]](#).

### Cable requirements

Feature	All sizes
Max. cable length	30 m

Tab. 155: Cable length [m]

## 11.4.13 X12: Safety technology (option ST6)

The ST6 safety module adds the STO safety function to the SD6 drive controller via terminal X12.

### Information

If you would like to use the STO safety function via terminals, be sure to read the manual for the ST6 safety module (see [Detailed information \[► 476\]](#)).

If you do not want to use the safety function, connect  $24 V_{DC}$  at  $STO_a$  and  $STO_b$ , e.g. using a connection with terminal X11.

### Technical data

Obey the technical data of the safety options at X12 (see [ST6 safety module \[► 59\]](#)).

Terminal	Pin	Designation	Function
 1 2 3 4 5 6 7 8	1	$STO_a$	Input of safety channel 1
	2		
	3	$STO_b$	Input of safety channel 2
	4		
	5	0 V GND	Reference potential for $STO_a$ and $STO_b$ , internally bridged with pin 7
	6	$STO_{status}$	Feedback signal of safety channels 1 and 2 for diagnostic purposes
	7	0 V GND	Reference potential for $STO_a$ and $STO_b$ , internally bridged with pin 5
	8	$U_{1status}$	STO supply $_{status}$ ; recommended fuse protection: max. 3.15 AT <sup>18</sup>

Tab. 156: X12 connection description

### Connecting wiring

For the connecting wiring, obey the terminal specification [BCF 3.81 180 SN \[► 428\]](#).

### Cable requirements

Feature	All sizes
Max. cable length	30 m

Tab. 157: Cable length [m]

<sup>18</sup>For UL-compliance, use of a 3.15 A fuse (time delay) is required. The fuse must be certified for DC voltage in accordance with UL 248.

### 11.4.14 X14: Safety technology – Safe inputs (SE6 option)

The SE6 safety module adds the expanded safety functions to the SD6 drive controller using terminals X14 and X15.

<b>Information</b>
<p>If you would like to use the expanded safety functionality via terminals, be sure to read the manual for the SE6 safety module (see <a href="#">Detailed information [▶ 476]</a>).</p>

#### Technical data

Note the technical data of the safety options at X14 and X15 (see [SE6 safety module \[▶ 60\]](#)).

Terminal	Pin	Designation	Function
<div style="display: flex; flex-direction: column; align-items: center;"> <div style="margin-bottom: 5px;">6   7   8   9   10</div>  <div style="margin-top: 5px;">1   2   3   4   5</div> </div>	1	I0	Safe digital input
	2	I1	Safe digital input
	3	I2	Safe digital input
	4	I3	Safe digital input
	5	0 V GND	Reference potential for digital inputs; internally connected to pin 10
	6	I4	Safe digital input
	7	I5	Safe digital input
	8	I6	Safe digital input
	9	I7	Safe digital input
	10	0 V GND	Reference potential for digital inputs; internally connected to pin 5

Tab. 158: X14 connection description

#### Connecting wiring

For the connecting wiring, note the [DFMC 1.5 -ST-3.5 \[▶ 429\]](#) terminal specification.

#### Cable requirements

Feature	All sizes
Max. cable length	30 m

Tab. 159: Cable length [m]

## 11.4.15 X15: Safety technology – Safe outputs, supply for X50 (SE6 option)

The SE6 safety module adds the expanded safety functions to the SD6 drive controller using terminals X14 and X15.

### Information

If you would like to use the expanded safety functionality via terminals, be sure to read the manual for the SE6 safety module (see [Detailed information \[► 476\]](#)).

### ATTENTION!

#### Loss of safety!

Overvoltages > 40 V<sub>DC</sub> in the coupling between the safety module and safety controller can lead to loss of safety. Exposing the digital 1-pole outputs of the safety module to an overvoltage of the safety controller can cause the deactivated outputs to output a 1 signal. For the safety controller, use a power supply unit with overvoltage protection for the output voltage. The output voltage must be limited to a maximum of 40 V<sub>DC</sub>.

#### Technical data

Note the technical data of the safety options at X14 and X15 (see [SE6 safety module \[► 60\]](#)).

Terminal	Pin	Designation	Function
 <p>5   6   7   8 1   2   3   4</p>	1	+24 V	24 V <sub>DC</sub> supply for digital outputs (PELV); fuse protection: max. 4 AT; the supply voltage is also needed if no safe outputs are used
	2	O0	Safe digital output
	3	O1	Safe digital output
	4	U <sub>2</sub>	Power supply voltage for external encoder
	5	O2	Safe digital output
	6	O3	Safe digital output
	7	O4	Safe digital output
	8	0 V GND	Reference potential for external encoder

Tab. 160: X15 connection description

#### Connecting wiring

For the connecting wiring, note the [DFMC 1.5 -ST-3.5 \[► 429\]](#) terminal specification.

#### Cable requirements

Feature	All sizes
Max. cable length	30 m

Tab. 161: Cable length [m]

### 11.4.16 X20: Motor

The motor is connected to X20. For size 3 device types, there is also the connection for the DC link connection and for a braking resistor at terminal X20.

#### Size 0

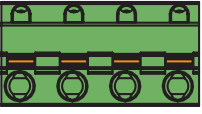
Terminal	Pin	Designation	Function
 1   2   3   4	1	U	Motor phase U connection
	2	V	Motor phase V connection
	3	W	Motor phase W connection
	4	PE	Grounding conductor

Tab. 162: X20 connection description – Size 0

For the connecting wiring, obey the terminal specification [GFKC 2,5 -ST-7,62 \[▶ 432\]](#).

#### Size 1

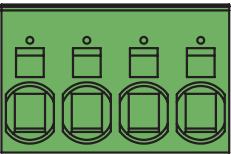
Terminal	Pin	Designation	Function
 1   2   3   4	1	U	Motor phase U connection
	2	V	Motor phase V connection
	3	W	Motor phase W connection
	4	PE	Grounding conductor

Tab. 163: X20 connection description – Size 1

For the connecting wiring, obey the terminal specification [SPC 5 -ST-7,62 \[▶ 434\]](#).

#### Size 2

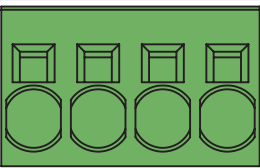
Terminal	Pin	Designation	Function
 1   2   3   4	1	U	Motor phase U connection
	2	V	Motor phase V connection
	3	W	Motor phase W connection
	4	PE	Grounding conductor

Tab. 164: X20 connection description – Size 2

For the connecting wiring, obey the terminal specification [SPC 16 -ST-10,16 \[▶ 435\]](#).

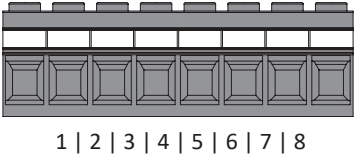

**Size 3**

Terminal	Pin	Designation	Function
	1	R-	Braking resistor
	2	R+	
	3	W	Motor phase W connection
	4	V	Motor phase V connection
	5	U	Motor phase U connection
	6	D-	DC link connection
	7	D+	
	8	PE	Grounding conductor

Tab. 165: X20 connection description – Size 3

For the connecting wiring, note the [MKDSP 25 -15,00 \[▶ 434\]](#) terminal specification.

**Cable requirements**

Motor type	Connection	Size 0 to 2	Size 3
Synchronous servo motor, asynchronous motor	Without output choke	50 m, shielded	100 m, shielded
Synchronous servo motor, asynchronous motor	With output choke	100 m, shielded	—

Tab. 166: Maximum cable length of the power cable [m]

**Information**

To ensure proper functionality, we recommend using cables from STOBER that are matched to the complete system. If unsuitable cables are used, we reserve the right to reject claims under the warranty.

**Shielded connection of the power cable**

Note the following points for the connection of the power cable:

- Ground the shield of the power cable on the shield contact on the drive controller intended for this.
- Keep the exposed conductors as short as possible. All devices and circuits that are sensitive to EMC must be kept at a distance of at least 0.3 m.

### 11.4.17 X30: DC link connection, braking resistor

Terminal X30 is available in sizes 0 to 2 for the DC link connection of the drive controller and for the connection of a braking resistor.

For setting up the Quick DC-Link, note the information on project configuration (see [DC link connection \[► 93\]](#)).

#### Size 0

Terminal	Pin	Designation	Function
	1	D-	DC link connection
	2	D+	
	3	R+	Braking resistor connection
	4	R-	

Tab. 167: X30 connection description – Size 0

For the connecting wiring, obey the terminal specification [GFKIC 2.5 -ST-7.62 \[► 432\]](#).

#### Size 1

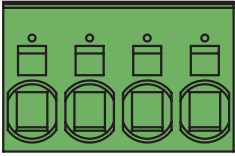
Terminal	Pin	Designation	Function
	1	D-	DC link connection
	2	D+	
	3	R+	Braking resistor connection
	4	R-	

Tab. 168: X30 connection description – Size 1

For the connecting wiring, obey the terminal specification [SPC 5 -ST-7,62 \[► 434\]](#).

#### Size 2

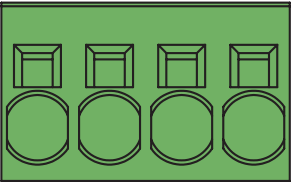
Terminal	Pin	Designation	Function
	1	D-	DC link connection
	2	D+	
	3	R+	Braking resistor connection
	4	R-	

Tab. 169: X30 connection description – Size 2

For the connecting wiring, obey the terminal specification [ISPC 16 -ST-10,16 \[► 433\]](#).

#### Size 3

For size 3 device types, the connections for the braking resistor and Quick DC-Link are part of terminal X20.

#### Wiring example

The example in the appendix (see [DC link connection \[► 438\]](#)) illustrates the basic connection of multiple SD6 drive controllers based on a DC link connection with a DL6A Quick DC-Link.

### 11.4.18 X50: Plausibility encoder (SE6 option)

At X50, differential TTL incremental encoders or SSI encoders can be connected. X50 is part of the SE6 safety module. X50 serves as the encoder plausibility check when using asynchronous motors or when using the SLP safety function.

#### Evaluable encoders

Note the technical data of the evaluable encoders at X50 (see [X50 \(SE6 option\)](#) [▶ 66]).

#### SSI encoders

Socket	Pin	Designation	Function
1   3   5   7  2   4   6   8	1	U <sub>2</sub>	Encoder supply (see terminal X15, pin 4)
	2	0 V GND	Reference potential for encoder supply to pin 1 (see terminal X15, pin 8)
	3	—	—
	4	Clock +	Differential input for CLOCK
	5	Clock –	Inverse differential input for CLOCK
	6	—	—
	7	Data +	Differential input for DATA
	8	Data –	Inverse differential input for DATA

Tab. 170: X50 connection description for SSI encoders

#### Differential TTL incremental encoders

Socket	Pin	Designation	Function
1   3   5   7  2   4   6   8	1	U <sub>2</sub>	Encoder supply (see terminal X15, pin 4)
	2	0 V GND	Reference potential for encoder supply to pin 1 (see terminal X15, pin 8)
	3	—	—
	4	A +	Differential input for A channel
	5	A –	Inverse differential input for A channel
	6	—	—
	7	B +	Differential input for B channel
	8	B –	Inverse differential input for B channel

Tab. 171: X50 connection description for differential TTL incremental encoders

#### 11.4.18.1 X50 adapter cable (SE6 option)

The adapter cable with open cable ends for connection to X50 is used to connect the plausibility encoder.

**Differential TTL incremental encoders**

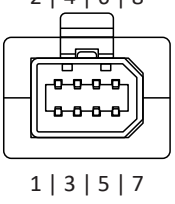
Connector	Pin	Designation	Color
	1	U <sub>2</sub>	WH
	2	0 V GND	BN
	3	N +	GN
	4	A +	GY
	5	A -	PK
	6	N -	YE
	7	B +	BU
	8	B -	RD

Tab. 172: X50 connector description for differential TTL incremental encoders

**11.4.19 Connecting a drive controller (ST6 option)**

**⚠ WARNING!**

**Electrical voltage! Risk of fatal injury due to electric shock!**

- Always switch off all power supply voltage before working on the devices!
- Note the discharge time of the DC link capacitors in the general technical data. You can only determine the absence of voltage after this time period.

**Tools and material**

You will need:

- Tool for assembling the accessory part and tightening the fastening screws.

## Requirements and connection

Bottom of the device:

- ✓ You have a system circuit diagram describing the connection of the drive controller.

1. Disconnect all terminals on the underside of the drive controller. For size 3 drive controllers, note that terminal X20 cannot be disconnected.
2. Sizes 0 to 2: In order to connect the motor temperature sensor, the control of the brake and the motor itself to the drive controller, wire the cores of the power cables with terminals X2, X5 and X20. Attach the power cable to the EMC shroud.

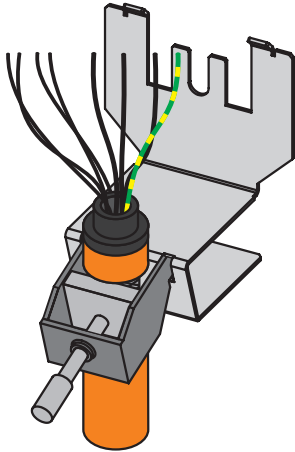

3. Size 3: Start by attaching the power cable to the EMC shroud. Then wire the cores of the power cable to terminals X2, X5 and X20 in order to connect the motor temperature sensor, the brake control and the motor itself to the drive controller.

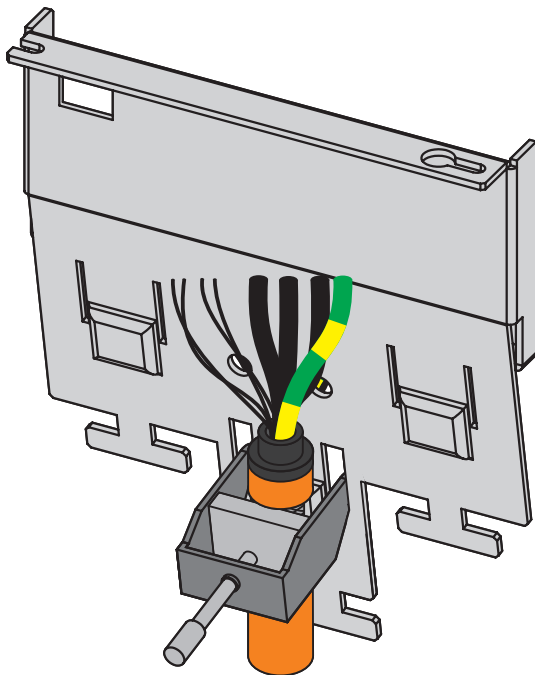

4. Sizes 0 to 2: Attach terminal X20.
5. Connect the supply voltage for the brake to terminal X6 and attach it.
6. Attach terminals X2 and X5.
7. Optional: Connect an encoder to terminal X4.
8. Wire the enable signal (pins 3 and 4) and optional relay 1 (pins 1 and 2) to terminal X1 and attach them.

Top of the device:

- ✓ There is a circuit diagram of the system that describes the connection of the drive controller
1. Connect the power supply to terminal X10.
  2. Connect the 24 V<sub>DC</sub> power supply for the control electronics to terminal X11.
  3. Connect terminal X12 according to your safety configuration.
  4. Optional: In order to use the IGB Motion Bus function, connect additional drive controllers to an IGB network via sockets X3A and X3B.
  5. Optional: Connect the EtherCAT, CANopen or PROFINET fieldbuses via the EC6, CA6 or PN6 modules to the sockets X200 and X201.

Wiring examples can be found in the appendix (see [Wiring examples](#) [▶ 436]).

## 11.4.20 Connecting a drive controller (SE6 option)

### WARNING!

**Electrical voltage! Risk of fatal injury due to electric shock!**

- Always switch off all power supply voltage before working on the devices!
- Note the discharge time of the DC link capacitors in the general technical data. You can only determine the absence of voltage after this time period.

### Tools and material

You will need:

- Tool for assembling the accessory part and tightening the fastening screws.

### Requirements and connection

Bottom of the device:

- ✓ You have a system circuit diagram describing the connection of the drive controller.
1. Disconnect all terminals on the underside of the drive controller. For size 3 drive controllers, note that terminal X20 cannot be disconnected.
  2. Sizes 0 to 2: In order to connect the motor temperature sensor, the brakes and the motor itself to the drive controller, wire the cores of the power cables to terminals X2, X5, X8 and X20. Attach the power cable to the EMC shroud.

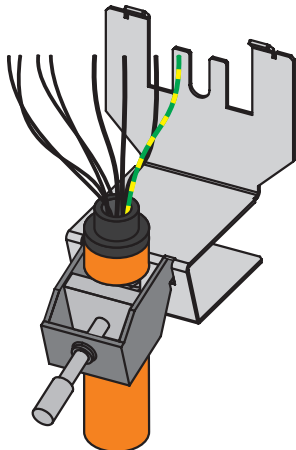

3. Size 3: Start by attaching the power cable to the EMC shroud. Then wire the cores of the power cable to terminals X2, X5, X8 and X20 in order to connect the motor temperature sensor, the brakes and the motor itself to the drive controller.

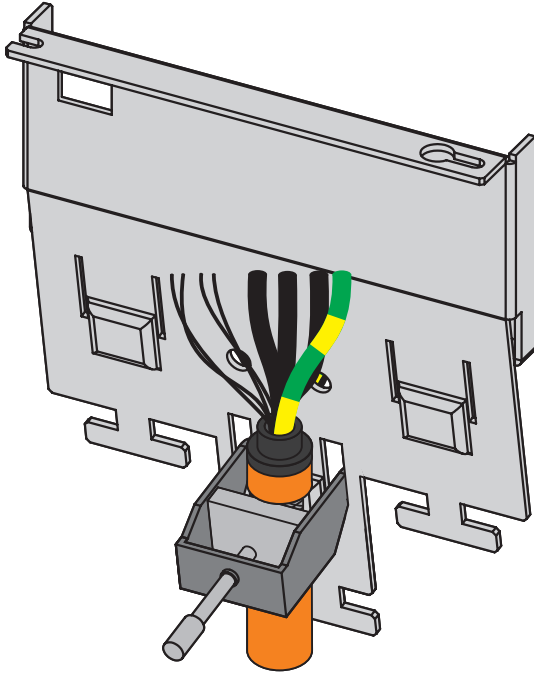

4. Sizes 0 to 2: Attach terminal X20.
5. Connect the supply voltage for the brakes to terminal X7 and attach it.
6. Attach terminals X2, X5 and X8.
7. Optional: Connect an encoder to terminal X4.
8. Wire the enable signal (pins 3 and 4) and optional relay 1 (pins 1 and 2) to terminal X1 and attach them.

Top of the device:

- ✓ You have a system circuit diagram describing the connection of the drive controller.
1. Connect the power supply to terminal X10.
  2. Optional: Connect the 24 V<sub>DC</sub> power supply for the control electronics to terminal X11.
  3. Connect terminals X14 and X15 according to your safety configuration and, optionally, connect the plausibility encoder to X50.
  4. Optional: In order to use the IGB Motion Bus function, connect additional drive controllers to an IGB network via sockets X3A and X3B.
  5. Optional: Connect the EtherCAT, CANopen or PROFINET fieldbuses via the EC6, CA6 or PN6 modules to the sockets X200 and X201.

Wiring examples can be found in the appendix (see [Wiring examples](#) [▶ 436]).

## 11.5 Braking resistor

### Information

If you are connecting an external braking resistor, take the following into consideration:

- Check whether a braking resistor is parameterized in DriveControlSuite. The brake chopper of the drive controller is active only if a braking resistor has been parameterized.
- For size 3 drive controllers, an externally connected braking resistor works alongside the integrated braking resistor with PTC characteristics.

### Housing grounding of the braking resistor

When grounding the housing of the braking resistor, obey the information on how to connect the grounding conductor correctly (see [Connection of the grounding conductor \[▶ 143\]](#)).

### 11.5.1 FZMU, FZZMU connection description

The internal connections of the tubular fixed resistor are wired to terminals with heat-resistant, silicone-insulated strands of wire. Also ensure a heat-resistant and sufficiently surge-proof design for the connection!

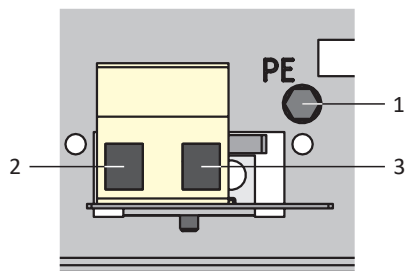

Fig. 42: FZMU connection overview

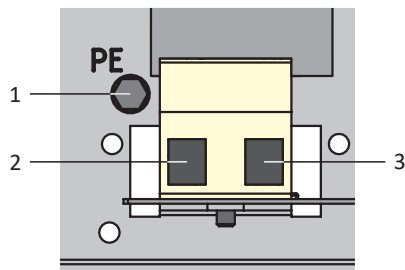

Fig. 43: FZZMU connection overview

### Sizes 0 to 2

No.	Function
1	Grounding conductor
2	RB+ drive controller braking resistor connection: X30, pin 3
3	RB- drive controller braking resistor connection: X30, pin 4

Tab. 173: Connection description of FZMU, FZZMU to sizes 0 to 2



**Size 3**

No.	Function
1	Grounding conductor
2	RB- drive controller braking resistor connection: X20, pin 1
3	RB+ drive controller braking resistor connection: X20, pin 2

Tab. 174: Connection description of FZMU, FZZMU to size 3

For the connecting wiring of the braking resistor, obey the terminal specification [G 10/2 \[▶ 431\]](#).

**11.5.2 GVADU, GBADU connection description**

GVADU flat resistors have two red cores for connecting to the drive controller, while GBADU flat resistors have one gray and one white core.

**Sizes 0 to 2**

Core color	Function
RD/GY	RB+ drive controller braking resistor connection: X30, pin 3
RD/WH	RB- drive controller braking resistor connection: X30, pin 4

Tab. 175: Connection description of GVADU, GBADU to sizes 0 to 2

**Size 3**

Core color	Function
GY	RB- drive controller braking resistor connection: X20, pin 1
WH	RB+ drive controller braking resistor connection: X20, pin 2

Tab. 176: Connection description of GBADU to size 3

### 11.5.3 FGFKU connection description

#### Sizes 0 to 2

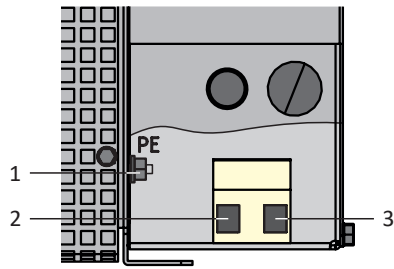

Fig. 44: FGFKU connection overview

No.	Function
1	Grounding conductor
2	RB+ drive controller braking resistor connection: X30, pin 3
3	RB- drive controller braking resistor connection: X30, pin 4

Tab. 177: Connection description of FGFKU to sizes 0 to 2

#### Size 3

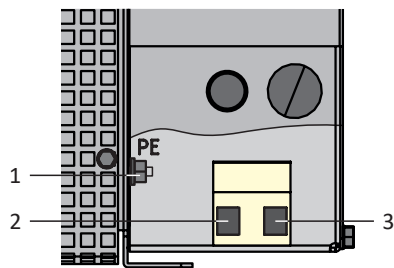

Fig. 45: FGFKU connection overview

No.	Function
1	Grounding conductor
2	RB- drive controller braking resistor connection: X20, pin 1
3	RB+ drive controller braking resistor connection: X20, pin 2

Tab. 178: Connection description of FGFKU to size 3

For the connecting wiring of the braking resistor, obey the terminal specification [G 10/2 \[▶ 431\]](#).

## 11.5.4 RB 5000 connection description

The rear section braking resistor has two red cores for connecting to the drive controller.

### Sizes 0 to 2

Core color	Function
RD	RB+ drive controller braking resistor connection: X30, pin 3
RD	RB- drive controller braking resistor connection: X30, pin 4

Tab. 179: Connection description of RB 5000 to sizes 0 to 2

## 11.6 Power choke

### WARNING!

#### Risk of burns! Fire hazard! Material damage!

Chokes and braking resistors can heat up to over 100 °C under permitted operating conditions.

- Take protective measures against accidental and intentional contact with the choke or braking resistor.
- Make sure that no flammable material is in the vicinity of the choke or braking resistor.
- Note the specified minimum clearances for installation.

### WARNING!

#### Fire hazard due to overheating!

Using chokes or braking resistors outside of the nominal data (cable length, current, frequency, etc.) can cause them to overheat.

- Always comply with the maximum nominal data when operating the chokes and braking resistors.

### 11.6.1 Connection description

Designation	Function
1U1	Phase L1 drive controller connection: X10, pin 1
1U2	Phase L1 network connection
1V1	Phase L2 drive controller connection: X10, pin 2
1V2	Phase L2 network connection
1W1	Phase L3 drive controller connection: X10, pin 3
1W2	Phase L3 network connection
PE	Grounding conductor

Tab. 180: TEP power choke connection description

#### Choke housing grounding

When grounding the housing of the choke, obey the information on how to connect the grounding conductor correctly (see [Connection of the grounding conductor](#) [▶ 143]).

## 11.7 Output choke

**⚠ WARNING!**

### Risk of burns! Fire hazard! Material damage!

Chokes and braking resistors can heat up to over 100 °C under permitted operating conditions.

- Take protective measures against accidental and intentional contact with the choke or braking resistor.
- Make sure that no flammable material is in the vicinity of the choke or braking resistor.
- Note the specified minimum clearances for installation.

**⚠ WARNING!**

### Fire hazard due to overheating!

Using chokes or braking resistors outside of the nominal data (cable length, current, frequency, etc.) can cause them to overheat.

- Always comply with the maximum nominal data when operating the chokes and braking resistors.

### 11.7.1 Connection description

Designation	Function
1U1	Phase U drive controller connection: X20, pin 1
1U2	Motor phase U connection
1V1	Phase V drive controller connection: X20, pin 2
1V2	Motor phase V connection
1W1	Phase W drive controller connection: X20, pin 3
1W2	Motor phase W connection
7	Drive controller grounding conductor: X20, Pin 4
8	Power cable grounding conductor

Tab. 181: TEP output choke connection description

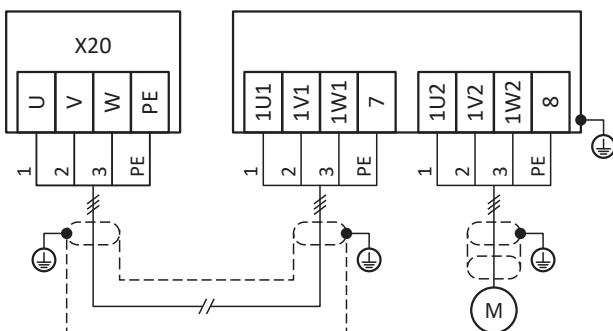

Fig. 46: TEP output choke connection example

### Shielded connection of the power cable

Note the following points for the connection of the power cable for a motor with output choke:

- Ground the shield of the power cable over large contact areas in the immediate vicinity of the output choke, for example with electrically conductive metal cable clips on a grounded busbar.
- Keep the exposed conductors as short as possible. All devices and circuits that are sensitive to EMC must be kept at a distance of at least 0.3 m.

The following graphic shows an example of the shielded connection of the power cable.

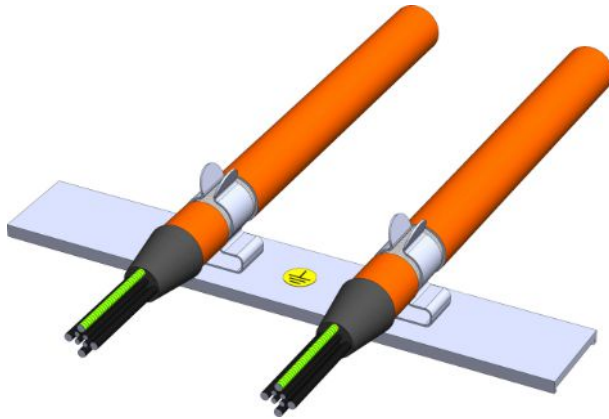

Fig. 47: Shielded connection of the power cable

### Choke housing grounding

When connecting the grounding conductor, obey the requirements described (see [Connection of the grounding conductor](#) [▶ 143]).

## 11.8 Communication module

The connection descriptions of the optional communication modules can be found in the following chapters.

### 11.8.1 EC6: EtherCAT

For the EtherCAT connection, you need the optional EC6 accessory part.

#### 11.8.1.1 Overview

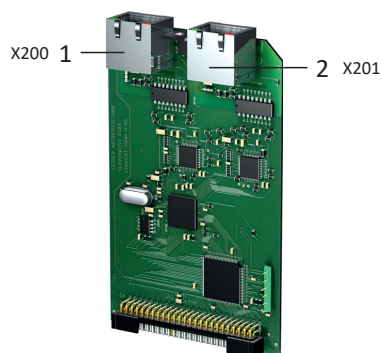

Fig. 48: Connection overview for EC6 communication module

- 1 X200: EtherCAT In
- 2 X201: EtherCAT Out

### 11.8.1.2 X200, X201: EtherCAT

The drive controllers have both RJ-45 sockets X200 and X201. The sockets are located on top of the device. The associated pin assignment and color coding correspond to the EIA/TIA-T568B standard.

X200 is to be connected as an input with the cable coming from the EtherCAT master. X201 is to be connected as an output with any subsequent EtherCAT nodes.

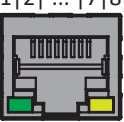
Socket	Pin	Designation	Function
	1	Tx+	Communication
	2	Tx-	
	3	Rx+	
	4	—	—
	5	—	—
	6	Rx-	Communication
	7	—	—
	8	—	—

Tab. 182: X200 and X201 connection description

#### Cable requirements

<b>Information</b>
--------------------

To ensure proper functionality, we recommend using cables from STOBER that are matched to the complete system. If unsuitable cables are used, we reserve the right to reject claims under the warranty.

STOBER provides ready-made cables for the EtherCAT connection. It is also possible to use cables with the following specification:

Ethernet patch cables or crossover cables meeting the CAT 5e quality level are the ideal cables. The Fast Ethernet technology allows a maximum cable length of 100 m between two nodes.

<b>Information</b>
--------------------

Ensure that you only use shielded cables with an SF/FTP, S/FTP or SF/UTP design.

#### Device addressing and fieldbus connection

For information on device addressing, see [Device addressing \[▶ 439\]](#).

Detailed information about the fieldbus connection can be found in the corresponding manual for communication with EtherCAT.

## 11.8.2 CA6: CANopen

The optional CA6 accessory part is available for the CANopen connection.

### 11.8.2.1 Overview

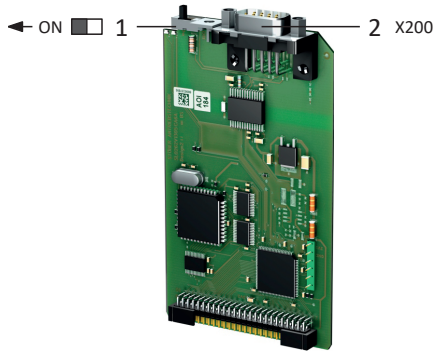

Fig. 49: Connection overview for CA6 communication module

- 1 Terminating resistor; must be activated at the last networked drive controller (slider to "ON")
- 2 X200: CANopen

### 11.8.2.2 X200: CANopen

The CA6 communication module provides a 9-pole D-sub connector for connecting the drive controllers to each other.

Connector	Pin	Designation	Function
	1	—	—
	2	CAN-L	CAN low wire
	3	GND	Reference potential
	4	—	—
	5	—	—
	6	—	—
	7	CAN-H	CAN high wire
	8	—	—
	9	—	—

Tab. 183: X200 connection description

### Cable requirements

In order to ensure error-free operation—especially at high transmission rates—we recommend using bus wires that meet the requirements listed in ISO 11898-2, such as the following:

- Characteristic impedance: 95 – 140  $\Omega$
- Maximum operating capacitance: 60 nF/km
- Conductor resistance: 70 m $\Omega$ /m

### Device addressing and fieldbus connection

For information on device addressing, see [Device addressing \[▶ 439\]](#).

For detailed information about the fieldbus connection, refer to the corresponding manual (see [Detailed information \[▶ 476\]](#)).

## 11.8.3 PN6: PROFINET

For a PROFINET connection, you need the optional PN6 accessory part.

### 11.8.3.1 Overview

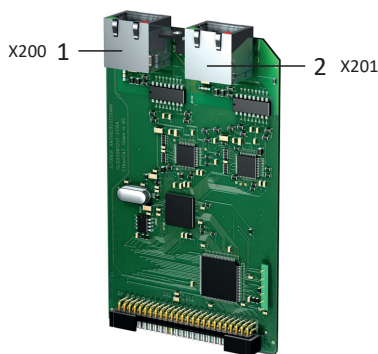

Fig. 50: Connection overview for PN6 communication module

- 1 X200: PROFINET
- 2 X201: PROFINET



### 11.8.3.2 X200, X201: PROFINET

In order to be able to connect the drive controllers to other PROFINET nodes, an integrated switch with both X200 and X201 RJ-45 sockets is provided. The sockets are located on top of the device. The associated pin assignment and color coding correspond to the EIA/TIA-T568B standard.

Connect X200 or X201 with the IO controller and the remaining connection with the next drive controller.

Socket	Pin	Designation	Function
	1	Tx+	Communication
	2	Tx-	
	3	Rx+	
	4	—	—
	5	—	—
	6	Rx-	Communication
	7	—	—
	8	—	—

Tab. 184: X200 and X201 connection description

#### Cable requirements

The connections between the nodes of a PROFINET network generally consist of symmetrical, shielded copper cables twisted in pairs (shielded twisted pair, CAT 5e quality level). Fiber-optic cables are also a possible means of transmission.

Signals are transmitted according to the 100BASE TX method, i.e. with a transfer rate of 100 Mbps at a frequency of 125 MHz. A maximum of 1440 bytes can be transferred per frame. The maximum cable length is 100 m.

PROFINET cables exist in different versions that are tailored to different application scenarios and ambient conditions.

We recommend using the cables and plug connectors specified in the PROFINET installation guidelines. They are adjusted for use in automation technology with regard to usage, resistance, EMC properties and color coding.

There are type A, B and C cables, differentiated by installation type:

- Type A  
4-wire shielded copper cable for fixed installation
- Type B  
4-wire shielded copper cable for flexible installation
- Type C  
4-wire shielded copper cable for constant movements

#### Device addressing and fieldbus connection

For information on device addressing, see [Device addressing \[▶ 439\]](#).

Detailed information about the fieldbus connection can be found in the corresponding manual for communication with PROFINET.

## 11.9 Terminal module

The connection descriptions of the optional terminal modules can be found in the following chapters.

### 11.9.1 XI6

#### 11.9.1.1 Overview

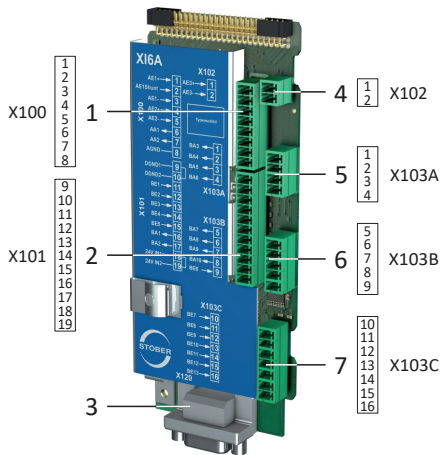



Fig. 51: Connection overview for the XI6 terminal module

- 1 X100: AI1 – AI2, AO1 – AO2
- 2 X101: DI1 – DI5, DO1 – DO2
- 3 X120: X120 encoder connection
- 4 X102: AI3
- 5 X103A: DO3 – DO6
- 6 X103B: DI6, DO7 – DO10
- 7 X103C: DI7 – DI13

### 11.9.1.2 X100: AI1 – AI2, AO1 – AO2

For the connection, note the technical data of the terminal module (see [X16 \[▶ 75\]](#)).

Terminal	Pin	Designation	Function
 1 2 3 4 5 6 7 8	1	AI1 +	AI1+ input
	2	AI1 shunt	Current input; shunt connection pin 2 is to be bridged to pin 1
	3	AI1 –	AI1– input
	4	AI2 +	AI2+ input
	5	AI2 –	AI2– input
	6	AO1	AO1 output
	7	AO2	AO2 output
	8	0 V AGND	Reference potential

Tab. 185: X100 connection description

#### Connecting wiring

For the connecting wiring, note the [FK-MCP 1,5 -ST-3,5 \[▶ 430\]](#) terminal specification.

#### Cable requirements

Feature	All sizes
Max. cable length	30 m

Tab. 186: Cable length [m]

### 11.9.1.3 X101: DI1 – DI5, DO1 – DO2

#### X101 for digital signals

For the evaluation of digital signals at X101, observe the technical data of the terminal module (see [X16 \[▶ 75\]](#)).

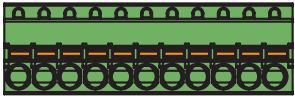
Terminal	Pin	Designation	Function	
 9 10 11  ...  17 18 19	9	0 V DGND	Reference potential, internally bridged	
	10			
	11	DI1	Digital inputs	
	12	DI2		
	13	DI3		
	14	DI4		
	15	DI5		
	16	DO1	Digital outputs	
	17	DO2		
	18	+24 V <sub>DC</sub>		External 24 V <sub>DC</sub> supply; recommended fuse protection: max. 1 A <sup>19</sup>
	19			

Tab. 187: X101 connection description for digital signals

<sup>19</sup> For the fuse protection, use a 1 A fuse (time delay). For UL-compliant use, be sure that the fuse meets certification requirements for DC voltage in accordance with UL 248.

### X101 for encoders

If you would like to use X101 as an encoder connection, obey the technical data of the evaluable encoders at X101 (see [X101 for encoders \[▶ 67\]](#)).

Use the digital inputs DI3 to DI5 to evaluate incremental or pulse/direction signals. For the simulation, use the digital outputs DO1 and DO2.

Hall sensors with single-ended HTL signal levels can be connected to digital inputs DI1 through DI3 directly.

### Single-ended HTL incremental encoders

Terminal	Pin	Designation	Function
 9 10 11  ...  17 18 19	9	0 V DGND	Reference potential, internally bridged
	10		
	11	DI1	—
	12	DI2	—
	13	DI3	Evaluation: N channel
	14	DI4	Evaluation: A channel
	15	DI5	Evaluation: B channel
	16	DO1	Simulation: A channel
	17	DO2	Simulation: B channel
	18	+24 V <sub>DC</sub>	
19			

Tab. 188: X101 connection description for single-ended HTL incremental signals

### Single-ended HTL pulse/direction interface

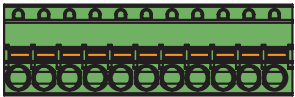
Terminal	Pin	Designation	Function
 9 10 11  ...  17 18 19	9	0 V DGND	Reference potential, internally bridged
	10		
	11	DI1	—
	12	DI2	—
	13	DI3	—
	14	DI4	Evaluation: Pulse
	15	DI5	Evaluation: Direction
	16	DO1	Simulation: Pulse
	17	DO2	Simulation: Direction
	18	+24 V <sub>DC</sub>	
19			

Tab. 189: X101 connection description for single-ended HTL pulse/direction signals

<sup>20</sup> For the fuse protection, use a 1 A fuse (time delay). For UL-compliant use, be sure that the fuse meets certification requirements in accordance with UL 248.

<sup>21</sup> For the fuse protection, use a 1 A fuse (time delay). For UL-compliant use, be sure that the fuse meets certification requirements in accordance with UL 248.

### Single-ended HTL Hall sensor

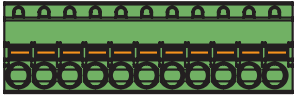
Terminal	Pin	Designation	Function
 9 10 11  ...  17 18 19	9	0 V DGND	Reference potential, internally bridged
	10		
	11	DI1	HALL A
	12	DI2	HALL B
	13	DI3	HALL C
	14	DI4	Digital inputs
	15	DI5	
	16	DO1	Digital outputs
	17	DO2	
	18	+24 V <sub>DC</sub>	External 24 V <sub>DC</sub> supply; recommended fuse protection: max. 1 AT <sup>22</sup>
	19		

Tab. 190: X101 connection description for single-ended HTL Hall sensor signals

### Connecting wiring

For the connecting wiring, note the [FK-MCP 1,5 -ST-3,5](#) [[▶ 430](#)] terminal specification.

### Cable requirements

Feature	All sizes
Max. cable length	30 m

Tab. 191: Cable length [m]

### 11.9.1.4 X102: AI3

For the connection, note the technical data of the terminal module (see [X16](#) [[▶ 75](#)]).

	Pin	Designation	Function
 1 2	1	AI3 +	AI3+ input; differential input voltage
	2	AI3 -	AI3- input

Tab. 192: X102 connection description

### Connecting wiring

For the connecting wiring, obey the terminal specification [FMC 1,5 -ST-3,5](#) [[▶ 431](#)].

### Cable requirements

Feature	All sizes
Max. cable length	30 m

Tab. 193: Cable length [m]

<sup>22</sup> For the fuse protection, use a 1 A fuse (time delay). For UL-compliant use, be sure that the fuse meets certification requirements for relevant DC voltage in accordance with UL 248.

### 11.9.1.5 X103A: DO3 – DO6

For the connection, note the technical data of the terminal module (see [X16](#) [▶ 75]).

Terminal	Pin	Designation	Function
 1 2 3 4	1	DO3	Digital outputs
	2	DO4	
	3	DO5	
	4	DO6	

Tab. 194: X103A connection description

#### Connecting wiring

For the connecting wiring, obey the terminal specification [FMC 1,5 -ST-3,5](#) [▶ 431].

#### Cable requirements

Feature	All sizes
Max. cable length	30 m

Tab. 195: Cable length [m]

### 11.9.1.6 X103B: DI6, DO7 – DO10

For the connection, note the technical data of the terminal module (see [X16](#) [▶ 75]).

#### Information

In the event of failure of the 24 V<sub>DC</sub> supply, the digital input DI6 displays the signal state 0, regardless of the physical signal state.

Terminal	Pin	Designation	Function
 5 6 7 8 9	5	DO7	Digital outputs
	6	DO8	
	7	DO9	
	8	DO10	
	9	DI6	Digital input

Tab. 196: X103B connection description

#### Connecting wiring

For the connecting wiring, obey the terminal specification [FMC 1,5 -ST-3,5](#) [▶ 431].

#### Cable requirements

Feature	All sizes
Max. cable length	30 m

Tab. 197: Cable length [m]

### 11.9.1.7 X103C: DI7 – DI13

For the connection, note the technical data of the terminal module (see [X16 \[▶ 75\]](#)).

<b>Information</b>
--------------------

In the event of failure of the 24 V<sub>DC</sub> supply, the digital inputs DI7 to DI13 display the signal state 0, regardless of the physical signal state.

Terminal	Pin	Designation	Function
 10 11  ...  15 16	10	DI7	Digital inputs
	11	DI8	
	12	DI9	
	13	DI10	
	14	DI11	
	15	DI12	
	16	DI13	

Tab. 198: X103C connection description

#### Connecting wiring

For the connecting wiring, obey the terminal specification [FMC 1,5 -ST-3,5 \[▶ 431\]](#).

#### Cable requirements

Feature	All sizes
Max. cable length	30 m

Tab. 199: Cable length [m]

### 11.9.1.8 X120

Note the technical data of the evaluable encoders at X120 (see [X120 \[▶ 69\]](#)).

#### SSI encoders

Connector	Pin	Designation	Function
 1   2   3   4   5 6   7   8   9	1	GND Enc	Reference potential for pin 2 to pin 7
	2	—	—
	3	—	—
	4	Clock –	Inverse differential input/output for CLOCK
	5	Clock +	Differential input/output for CLOCK
	6	Data +	Differential input/output for DATA
	7	Data –	Inverse differential input/output for DATA
	8	U <sub>2</sub>	Encoder supply
	9	0 V GND	Reference potential for pin 8

Tab. 200: X120 connection description for SSI encoders

### Differential TTL incremental encoders

Connector	Pin	Designation	Function
 <p>1   2   3   4   5</p> <p>6   7   8   9</p>	1	GND Enc	Reference potential for pin 2 to pin 7
	2	N +	Differential input/output for N channel
	3	N –	Inverse differential input/output for N channel
	4	A –	Inverse differential input/output for A channel
	5	A +	Differential input/output for A channel
	6	B +	Differential input/output for B channel
	7	B –	Inverse differential input/output for B channel
	8	U <sub>2</sub>	Encoder supply
	9	0 V GND	Reference potential for pin 8

Tab. 201: X120 connection description for differential TTL incremental encoder

### Differential TTL Hall sensor

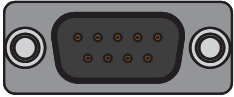
Connector	Pin <sup>23</sup>	Designation	Function
 <p>1   2   3   4   5</p> <p>6   7   8   9</p>	1	GND Enc	Reference potential for pin 2 to pin 7
	2	HALL C +	Differential input for HALL C
	3	HALL C –	Inverse differential input for HALL C
	4	HALL A –	Inverse differential input for HALL A
	5	HALL A +	Differential input for HALL A
	6	HALL B +	Differential input for HALL B
	7	HALL B–	Inverse differential input for HALL B
	8	U <sub>2</sub>	Encoder supply
	9	0 V GND	Reference potential for pin 8

Tab. 202: X120 connection description for differential TTL Hall sensors

### Differential TTL pulse/direction interface

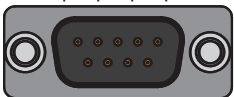
Connector	Pin <sup>24</sup>	Designation	Function
 <p>1   2   3   4   5</p> <p>6   7   8   9</p>	1	GND Enc	Reference potential for pin 2 to pin 7
	2	—	—
	3	—	—
	4	Pulse –	Inverse differential input for pulses
	5	Pulse +	Differential input for pulses
	6	Direction +	Differential input for direction
	7	Direction –	Inverse differential input for direction
	8	U <sub>2</sub>	Encoder supply
	9	0 V GND	Reference potential for pin 8

Tab. 203: X120 connection description for differential TTL pulse/direction signals

<sup>23</sup> 1:1 connection to LA6: Pin assignment corresponds to terminal X301

<sup>24</sup> 1:1 connection to LA6: Pin assignment corresponds to terminal X301



**Cable requirements**

Feature	All sizes
Max. cable length	50 m, shielded

Tab. 204: Cable length [m]

**11.9.2 RI6**

**11.9.2.1 Overview**

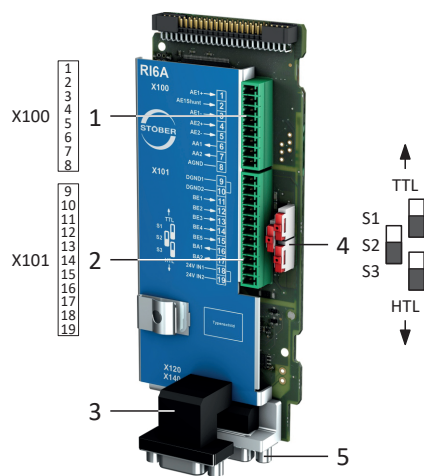
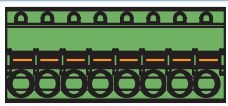

Fig. 52: Connection overview for the RI6 terminal module

- 1 X100: AI1 – AI2, AO1 – AO2
- 2 X101: DI1 – DI5, DO1 – DO2
- 3 X120: Encoder connection
- 4 3 sliders for the HTL/TTL level conversion
- 5 X140: Encoder connection

**11.9.2.2 X100: AI1 – AI2, AO1 – AO2**

For the connection, note the technical data of the terminal module (see [RI6 \[▶ 77\]](#)).

Terminal	Pin	Designation	Function
 <p>1 2 3 4 5 6 7 8</p>	1	AI1 +	AI1+ input
	2	AI1 shunt	Current input; shunt connection pin 2 is to be bridged to pin 1
	3	AI1 –	AI1– input
	4	AI2 +	AI2+ input
	5	AI2 –	AI2– input
	6	AO1	AO1 output
	7	AO2	AO2 output
	8	0 V AGND	Reference potential

Tab. 205: X100 connection description

**Connecting wiring**

For the connecting wiring, note the [FK-MCP 1,5 -ST-3,5 \[▶ 430\]](#) terminal specification.

**Cable requirements**

Feature	All sizes
Max. cable length	30 m

Tab. 206: Cable length [m]

11.9.2.3 X101: DI1 – DI5, DO1 – DO2

**X101 for digital signals**

For the evaluation of digital signals at X101, observe the technical data of the terminal module (see [R16 \[▶ 77\]](#)).

Terminal	Pin	Designation	Function	
 9 10 11  ...  17 18 19	9	0 V DGND	Reference potential, internally bridged	
	10			
	11	DI1	Digital inputs	
	12	DI2		
	13	DI3		
	14	DI4		
	15	DI5		
	16	DO1	Digital outputs	
	17	DO2		
	18	+24 V <sub>DC</sub>		External 24 V <sub>DC</sub> supply; recommended fuse protection: max. 1 A <sup>25</sup>
	19			

Tab. 207: X101 connection description for digital signals

<sup>25</sup> For the fuse protection, use a 1 A fuse (time delay). For UL-compliant use, be sure that the fuse meets certification requirements for DC voltage in accordance with UL 248.

### X101 for encoders

If you would like to use X101 as an encoder connection, obey the technical data of the evaluable encoders at X101 (see [X101 for encoders](#) [▶ 67]).

Use the digital inputs DI3 to DI5 to evaluate incremental or pulse/direction signals. For the simulation, use the digital outputs DO1 and DO2.

Hall sensors with single-ended HTL signal levels can be connected to digital inputs DI1 through DI3 directly.

### Single-ended HTL and single-ended TTL incremental encoders

Terminal	Pin	Designation	Function
 9 10 11  ...  17 18 19	9	0 V DGND	Reference potential, internally bridged
	10		
	11	DI1	—
	12	DI2	—
	13	DI3	Evaluation: N channel
	14	DI4	Evaluation: A channel
	15	DI5	Evaluation: B channel
	16	DO1	Simulation: A channel
	17	DO2	Simulation: B channel
	18	+24 V <sub>DC</sub>	
19			

Tab. 208: X101 connection description for single-ended HTL and single-ended TTL incremental signals

### Single-ended HTL and single-ended TTL pulse/direction interface

Terminal	Pin	Designation	Function
 9 10 11  ...  17 18 19	9	0 V DGND	Reference potential, internally bridged
	10		
	11	DI1	—
	12	DI2	—
	13	DI3	—
	14	DI4	Evaluation: Pulse
	15	DI5	Evaluation: Direction
	16	DO1	Simulation: Pulse
	17	DO2	Simulation: Direction
	18	+24 V <sub>DC</sub>	
19			

Tab. 209: X101 connection description for single-ended HTL and single-ended TTL pulse/direction signals

<sup>26</sup> For the fuse protection, use a 1 A fuse (time delay). For UL-compliant use, be sure that the fuse meets certification requirements in accordance with UL 248.

<sup>27</sup> For the fuse protection, use a 1 A fuse (time delay). For UL-compliant use, be sure that the fuse meets certification requirements in accordance with UL 248.

**Single-ended HTL Hall sensor**

Terminal	Pin	Designation	Function
 9 10 11  ...  17 18 19	9	0 V DGND	Reference potential, internally bridged
	10		
	11	DI1	HALL A
	12	DI2	HALL B
	13	DI3	HALL C
	14	DI4	Digital inputs
	15	DI5	
	16	DO1	Digital outputs
	17	DO2	
	18	+24 V <sub>DC</sub>	External 24 V <sub>DC</sub> supply; recommended fuse protection: max. 1 A <sup>T28</sup>
19			

Tab. 210: X101 connection description for single-ended HTL Hall sensor signals

**Connecting wiring**

For the connecting wiring, note the [FK-MCP 1,5 -ST-3,5 \[▶ 430\]](#) terminal specification.

**Cable requirements**

Feature	All sizes
Max. cable length	30 m

Tab. 211: Cable length [m]

11.9.2.4 X120

Note the technical data of the evaluable encoders at X120 (see [X120 \[▶ 69\]](#)).

**SSI encoders**

Connector	Pin	Designation	Function
 1   2   3   4   5 6   7   8   9	1	GND Enc	Reference potential for pin 2 to pin 7
	2	—	—
	3	—	—
	4	Clock -	Inverse differential input/output for CLOCK
	5	Clock +	Differential input/output for CLOCK
	6	Data +	Differential input/output for DATA
	7	Data -	Inverse differential input/output for DATA
	8	U <sub>2</sub>	Encoder supply
	9	0 V GND	Reference potential for pin 8

Tab. 212: X120 connection description for SSI encoders

<sup>28</sup> For the fuse protection, use a 1 A fuse (time delay). For UL-compliant use, be sure that the fuse meets certification requirements for relevant DC voltage in accordance with UL 248.

### Differential TTL incremental encoders

Connector	Pin	Designation	Function
 <p>1   2   3   4   5</p> <p>6   7   8   9</p>	1	GND Enc	Reference potential for pin 2 to pin 7
	2	N +	Differential input/output for N channel
	3	N –	Inverse differential input/output for N channel
	4	A –	Inverse differential input/output for A channel
	5	A +	Differential input/output for A channel
	6	B +	Differential input/output for B channel
	7	B –	Inverse differential input/output for B channel
	8	U <sub>2</sub>	Encoder supply
	9	0 V GND	Reference potential for pin 8

Tab. 213: X120 connection description for differential TTL incremental encoder

### Differential TTL Hall sensor

Connector	Pin <sup>29</sup>	Designation	Function
 <p>1   2   3   4   5</p> <p>6   7   8   9</p>	1	GND Enc	Reference potential for pin 2 to pin 7
	2	HALL C +	Differential input for HALL C
	3	HALL C –	Inverse differential input for HALL C
	4	HALL A –	Inverse differential input for HALL A
	5	HALL A +	Differential input for HALL A
	6	HALL B +	Differential input for HALL B
	7	HALL B–	Inverse differential input for HALL B
	8	U <sub>2</sub>	Encoder supply
	9	0 V GND	Reference potential for pin 8

Tab. 214: X120 connection description for differential TTL Hall sensors

### Differential TTL pulse/direction interface

Connector	Pin <sup>30</sup>	Designation	Function
 <p>1   2   3   4   5</p> <p>6   7   8   9</p>	1	GND Enc	Reference potential for pin 2 to pin 7
	2	—	—
	3	—	—
	4	Pulse –	Inverse differential input for pulses
	5	Pulse +	Differential input for pulses
	6	Direction +	Differential input for direction
	7	Direction –	Inverse differential input for direction
	8	U <sub>2</sub>	Encoder supply
	9	0 V GND	Reference potential for pin 8

Tab. 215: X120 connection description for differential TTL pulse/direction signals

<sup>29</sup> 1:1 connection to LA6: Pin assignment corresponds to terminal X301

<sup>30</sup> 1:1 connection to LA6: Pin assignment corresponds to terminal X301

**Cable requirements**

Feature	All sizes
Max. cable length	50 m, shielded

Tab. 216: Cable length [m]

11.9.2.5 X140

Note the technical data of the evaluable encoders at X140 (see [X140 \[► 70\]](#)).

**EnDat 2.1/2.2 digital encoders**

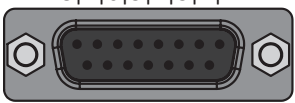
Socket	Pin	Designation	Function
	1	—	—
	2	0 V GND	Reference potential for encoder supply to pin 4
	3	—	—
	4	U <sub>2</sub>	Encoder supply
	5	Data +	Differential input for DATA
	6	—	—
	7	—	—
	8	Clock +	Differential input for CLOCK
	9	—	—
	10	0 V Sense	Optional reference potential of the Sense connection for regulating the encoder supply
	11	—	—
	12	U <sub>2</sub> Sense	Sense signals for voltage regulation
	13	Data -	Inverse differential input for DATA
	14	—	—
	15	Clock -	Inverse differential input for CLOCK

Tab. 217: X140 connection description for EnDat 2.1/2.2 digital encoders

## Resolver

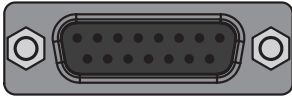
Socket	Pin	Designation	Function
	1	S4 Sin +	Sin input
	2	R1 Ref -	Reference potential for pin 6
	3	S3 Cos +	Cos input
	4	—	—
	5	—	—
	6	R2 Ref +	Resolver excitation signal
	7	1TP1	Reserve
	8	—	—
	9	S2 Sin -	Reference potential for pin 1
	10	—	—
	11	S1 Cos -	Reference potential for pin 3
	12	—	—
	13	—	—
	14	1TP2	Reserve
	15	—	—

Tab. 218: X140 connection description for resolvers

## EnDat 2.1 sin/cos encoders

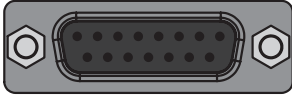
Socket	Pin	Designation	Function
	1	B - (Sin -)	Reference potential for sin input
	2	0 V GND	Reference potential for encoder supply to pin 4
	3	A - (Cos -)	Reference potential for cos input
	4	U <sub>2</sub>	Encoder supply
	5	Data +	Differential input for DATA
	6	—	—
	7	1TP1	Reserve
	8	Clock +	Differential input for CLOCK
	9	B + (Sin +)	Sin input
	10	0 V Sense	Optional reference potential of the Sense connection for regulating the encoder supply
	11	A + (Cos +)	Cos input
	12	U <sub>2</sub> Sense	Sense signals for voltage regulation
	13	Data -	Inverse differential input for DATA
	14	1TP2	Reserve
	15	Clock -	Inverse differential input for CLOCK

Tab. 219: X140 connection description for EnDat 2.1 sin/cos encoders

**Sin/cos encoders**

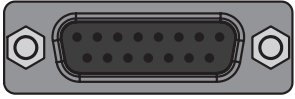
Socket	Pin	Designation	Function
	1	B – (Sin –)	Reference potential for sin input
	2	0 V GND	Reference potential for encoder supply to pin 4
	3	A – (Cos –)	Reference potential for cos input
	4	U <sub>2</sub>	Encoder supply
	5	—	—
	6	—	—
	7	—	—
	8	—	—
	9	B + (Sin +)	Sin input
	10	0 V Sense	Optional Sense connection for regulating the encoder supply
	11	A + (Cos +)	Cos input
	12	U <sub>2</sub> Sense	Sense signals for voltage regulation
	13	—	—
	14	—	—
	15	—	—

Tab. 220: X140 connection description for sin/cos encoders

**Cable requirements**

Feature	All sizes
Max. cable length	100 m, shielded

Tab. 221: Cable length [m]

11.9.2.6 AP6 interface adapter (resolver)

**AP6A00 – Resolver (9-pin to 15-pin)**

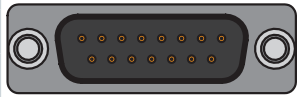
Socket <sup>31</sup>	Pin	Designation	Function	Pin	Connector <sup>32</sup>
	1	—	—	—	
	2	1TP1	—	—	
	3	S2 Sin –	Reference potential for sin input	9	
	4	S1 Cos –	Reference potential for cos input	11	
	5	R1 Ref –	Reference potential for resolver excitation signal	2	
	6	1TP2	—	—	
	7	S4 Sin +	Sin input	1	
	8	S3 Cos +	Cos input	3	
	9	R2 Ref +	Resolver excitation signal	6	

Tab. 222: AP6A00 connection description for resolver (9-pin to 15-pin)

<sup>31</sup>View of 9-pin D-sub for connecting the SDS 4000-compatible resolver cable

<sup>32</sup>View of 15-pin D-sub for connecting to SD6, terminal X140 (RI6)



**AP6A01 – Resolver and motor temperature sensor (9-pin to 15-pin)**

Interface adapter with temperature sensor cores routed out on the side.

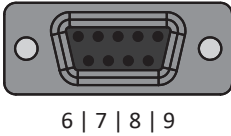
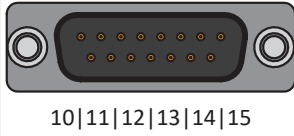
Socket <sup>33</sup>	Pin	Designation	Function	Pin	Connector <sup>34</sup>
	1	—	—	—	
	2	1TP1	Motor temperature sensor connection, if included in the encoder cable connector; routed out for the direct connection to terminal X2	—	
	3	S2 Sin –	Reference potential for sin input	9	
	4	S1 Cos –	Reference potential for cos input	11	
	5	R1 Ref –	Reference potential for resolver excitation signal	2	
	6	1TP2	Motor temperature sensor connection, if included in the encoder cable connector; routed out for the direct connection to terminal X2	—	
	7	S4 Sin +	Sin input	1	
	8	S3 Cos +	Cos input	3	
	9	R2 Ref +	Resolver excitation signal	6	

Tab. 223: AP6A01 connection description for the resolver and motor temperature sensor (9-pin to 15-pin)

<sup>33</sup>View of 9-pin D-sub for connecting the SDS 4000-compatible resolver cable

<sup>34</sup>View of 15-pin D-sub for connecting to SD6, terminal X140 (R16)

### 11.9.2.7 AP6 interface adapter (EnDat 2.1 sin/cos)

#### AP6A02 – EnDat 2.1 sin/cos encoder (15-pin to 15-pin)

Interface adapter with temperature sensor cores routed out on the side.

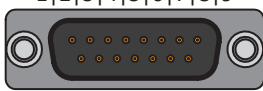
Socket <sup>35</sup>	Pin	Designation	Function	Pin	Connector <sup>36</sup>
	1	B – (Sin –)	Reference potential for sin input	1	
	2	0 V GND	Reference potential for encoder supply	2	
	3	A – (Cos –)	Reference potential for cos input	3	
	4	U <sub>2</sub>	Encoder supply	4	
	5	Data +	Differential input for DATA	5	
	6	—	—	6	
	7	1TP1	Motor temperature sensor connection, if included in the encoder cable; routed out for the direct connection to X2	—	
	8	Clock +	Differential input for CLOCK	8	
	9	B + (Sin +)	Sin input	9	
	10	0 V Sense	Optional reference potential of the Sense connection for regulating the encoder supply	10	
	11	A + (Cos +)	Cos input	11	
	12	U <sub>2</sub> Sense	Sense signals for voltage excitation	12	
	13	Data –	Inverse differential input for DATA	13	
	14	1TP2	Motor temperature sensor connection, if included in the encoder cable; routed out for the direct connection to X2	—	
	15	Clock –	Inverse differential input for CLOCK	15	

Tab. 224: AP6A02 connection description for EnDat 2.1 sin/cos encoder and motor temperature sensor (15-pin to 15-pin)

<sup>35</sup> View of 15-pin D-sub for connecting the SDS 4000-compatible EnDat cable

<sup>36</sup> View of 15-pin D-sub for connecting to SD6, terminal X140 (RI6)

### 11.9.3 IO6

#### 11.9.3.1 Overview

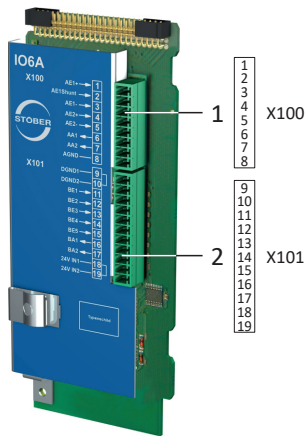
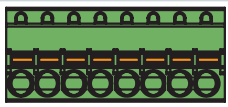

Fig. 53: Connection overview for the IO6 terminal module

- 1 X100: AI1 – AI2, AO1 – AO2
- 2 X101: DI1 – DI5, DO1 – DO2

#### 11.9.3.2 X100: AI1 – AI2, AO1 – AO2

For the connection, observe the technical data of the terminal module (see [IO6 \[▶ 78\]](#)).

Terminal	Pin	Designation	Function
 1 2 3 4 5 6 7 8	1	AI1 +	AI1+ input
	2	AI1 shunt	Current input; shunt connection pin 2 is to be bridged to pin 1
	3	AI1 –	AI1- input
	4	AI2 +	AI2+ input
	5	AI2 –	AI2- input
	6	AO1	AO1 output
	7	AO2	AO2 output
	8	0 V AGND	Reference potential

Tab. 225: X100 connection description

#### Connecting wiring

For the connecting wiring, note the [FK-MCP 1,5 -ST-3,5 \[▶ 430\]](#) terminal specification.

#### Cable requirements

Feature	All sizes
Max. cable length	30 m

Tab. 226: Cable length [m]

### 11.9.3.3 X101: DI1 – DI5, DO1 – DO2

#### X101 for digital signals

For the evaluation of digital signals at X101, observe the technical data of the terminal module (see [IO6](#) [▶ 78]).

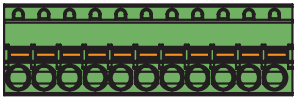
Terminal	Pin	Designation	Function
 9 10 11  ...  17 18 19	9	0 V DGND	Reference potential, internally bridged
	10		
	11	DI1	Digital inputs
	12	DI2	
	13	DI3	
	14	DI4	
	15	DI5	
	16	DO1	Digital outputs
	17	DO2	
	18	+24 V <sub>DC</sub>	
19			

Tab. 227: X101 connection description for digital signals

<sup>37</sup> For the fuse protection, use a 1 A fuse (time delay). For UL-compliant use, be sure that the fuse meets certification requirements for DC voltage in accordance with UL 248.

### X101 for encoders

If you would like to use X101 as an encoder connection, obey the technical data of the evaluable encoders at X101 (see [X101 for encoders \[▶ 67\]](#)).

Use the digital inputs DI3 to DI5 to evaluate incremental or pulse/direction signals. For the simulation, use the digital outputs DO1 and DO2.

Hall sensors with single-ended HTL signal levels can be connected to digital inputs DI1 through DI3 directly.

#### Single-ended HTL incremental encoders

Terminal	Pin	Designation	Function
 9 10 11  ...  17 18 19	9	0 V DGND	Reference potential, internally bridged
	10		
	11	DI1	—
	12	DI2	—
	13	DI3	Evaluation: N channel
	14	DI4	Evaluation: A channel
	15	DI5	Evaluation: B channel
	16	DO1	Simulation: A channel
	17	DO2	Simulation: B channel
	18	+24 V <sub>DC</sub>	External 24 V <sub>DC</sub> supply; recommended fuse protection: max. 1 A <sup>38</sup>
	19		

Tab. 228: X101 connection description for single-ended HTL incremental signals

#### Single-ended HTL pulse/direction interface

Terminal	Pin	Designation	Function
 9 10 11  ...  17 18 19	9	0 V DGND	Reference potential, internally bridged
	10		
	11	DI1	—
	12	DI2	—
	13	DI3	—
	14	DI4	Evaluation: Pulse
	15	DI5	Evaluation: Direction
	16	DO1	Simulation: Pulse
	17	DO2	Simulation: Direction
	18	+24 V <sub>DC</sub>	External 24 V <sub>DC</sub> supply; recommended fuse protection: max. 1 A <sup>39</sup>
	19		

Tab. 229: X101 connection description for single-ended HTL pulse/direction signals

<sup>38</sup> For the fuse protection, use a 1 A fuse (time delay). For UL-compliant use, be sure that the fuse meets certification requirements in accordance with UL 248.

<sup>39</sup> For the fuse protection, use a 1 A fuse (time delay). For UL-compliant use, be sure that the fuse meets certification requirements in accordance with UL 248.

**Single-ended HTL Hall sensor**

Terminal	Pin	Designation	Function
 9 10 11  ...  17 18 19	9	0 V DGND	Reference potential, internally bridged
	10		
	11	DI1	HALL A
	12	DI2	HALL B
	13	DI3	HALL C
	14	DI4	Digital inputs
	15	DI5	
	16	DO1	Digital outputs
	17	DO2	
	18	+24 V <sub>DC</sub>	External 24 V <sub>DC</sub> supply; recommended fuse protection: max. 1 A <sup>40</sup>
	19		

Tab. 230: X101 connection description for single-ended HTL Hall sensor signals

**Connecting wiring**

For the connecting wiring, note the [FK-MCP 1,5 -ST-3,5 \[▶ 430\]](#) terminal specification.

**Cable requirements**

Feature	All sizes
Max. cable length	30 m

Tab. 231: Cable length [m]

<sup>40</sup> For the fuse protection, use a 1 A fuse (time delay). For UL-compliant use, be sure that the fuse meets certification requirements for relevant DC voltage in accordance with UL 248.

## 11.10 Encoder adapter box

The differential TTL incremental encoders in combination with a single-ended TTL Hall sensor for determining commutation are connected to the drive controller using the LA6 adapter box. In this process, LA6 is responsible for adjusting the Hall sensor signals. In addition to the adapter box, an XI6, IO6 or RI6 terminal module is required for connecting the Hall sensor to ST6. The incremental encoder is connected to terminal X4 of the drive controller.

The connection of the Hall sensor varies depending on the terminal module as follows:

- XI6: Connection to terminal X120 or X101
- RI6: Connection to terminal X120 or X101
- IO6: Connection to X101

---

<b>Information</b>
--------------------

To ensure proper functionality, we recommend using cables from STOBER that are matched to the complete system. If unsuitable cables are used, we reserve the right to reject claims under the warranty.

---

### 11.10.1 LA6 for synchronous linear motors

The LA6 adapter box is responsible for converting and transmitting TTL signals from synchronous linear motors to the SD6 drive controller.

#### 11.10.1.1 Overview

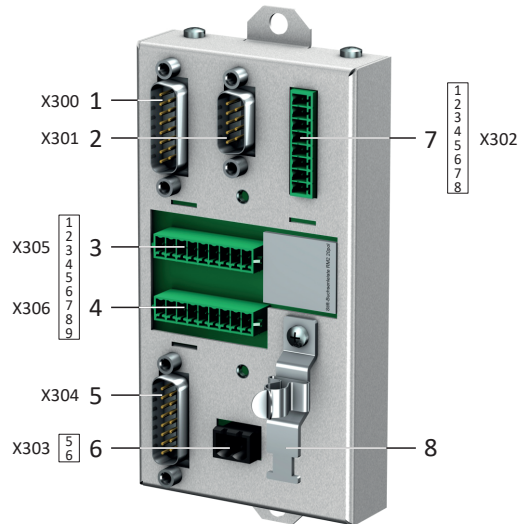

Fig. 54: Connection overview for the LA6 adapter box

- 1 X300: Connection to SD6, terminal X4
- 2 X301: Connection to SD6, terminal X120 on XI6 or RI6 terminal module
- 3 X305: Connection of TTL (incremental encoder and Hall sensor) using loose cable ends
- 4 X306: Connection of TTL (incremental encoder and Hall sensor) using loose cable ends
- 5 X304: Connection of TTL (incremental encoder and Hall sensor) using D-sub connector
- 6 X303: 24 V<sub>DC</sub> supply
- 7 X302: Connection to SD6, terminal X101 on XI6, RI6 or IO6 terminal module
- 8 Shield connection for encoder for connection using loose cable ends



### 11.10.1.2 X300: Encoder at X4

X300 transmits differential TTL incremental signals to connection X4 of the drive controller.

Observe the technical data for the X300 connection (see [X300](#) [▶ 73]).

#### Differential TTL incremental encoders

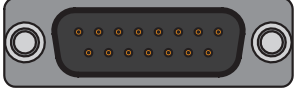
Socket	Pin <sup>41</sup>	Designation	Function
	1	—	—
	2	0 V GND	Reference potential for encoder supply to pin 4
	3	—	—
	4	U <sub>2</sub>	Encoder supply
	5	B +	Differential output for B channel
	6	—	—
	7	N +	Differential output for N channel
	8	A +	Differential output for A channel
	9	—	—
	10	—	—
	11	—	—
	12	U <sub>2</sub> Sense	Sense connection for regulating the encoder supply
	13	B -	Inverse differential output for B channel
	14	N -	Inverse differential output for the N channel
	15	A -	Inverse differential output for the A channel

Tab. 232: X300 connection description for differential TTL incremental encoders

#### Cable requirements

Feature	All sizes
Max. cable length, in total (motor to adapter box to drive controller)	100 m, shielded

Tab. 233: Cable length [m]

<sup>41</sup> 1:1 connection to SD6: Pin assignment corresponds to terminal X4. Both the encoder supply and the sense line pass through the LA6 to the drive controller.

### 11.10.1.3 X301: Hall sensor at X120

X301 converts single-ended TTL Hall sensor signals for the transmission to connection X120 on the XI6 or RI6 terminal module.

Observe the technical data for the X301 connection (see [X301 \[► 73\]](#)).

#### Differential TTL Hall sensor

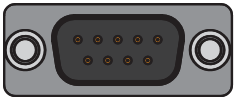
Connector	Pin <sup>42</sup>	Designation	Function
	1	GND Enc	Reference potential for pin 4 to pin 7
	2	HALL C +	Differential output for HALL C
	3	HALL C –	Inverse differential output for HALL C
	4	HALL A –	Inverse differential output for HALL A
	5	HALL A +	Differential output for HALL A
	6	HALL B +	Differential output for HALL B
	7	HALL B –	Inverse differential output for HALL B
	8	U <sub>2</sub> <sup>43</sup>	Encoder supply
	9	0 V GND	Reference potential for pin 8

Tab. 234: X301 connection description for differential TTL hall sensors

#### Cable requirements

Feature	All sizes
Max. cable length	50 m, shielded

Tab. 235: Cable length [m]

<sup>42</sup> 1:1 connection to SD6: Pin assignment corresponds to terminal X120 on terminal module XI6 or RI6.

<sup>43</sup> The encoder supply passes through the LA6 to the drive controller.

### 11.10.1.4 X302: Hall sensor at X101

X302 converts single-ended TTL Hall sensor signals for the transmission to connection X101 on the XI6, RI6 or IO6 terminal module.

Note the technical data for the X302 connection (see [X302](#) [▶ 74]).

#### Single-ended TTL Hall sensor

Terminal	Pin	Designation	Function
 1 2 3 4 5 6 7 8	1	HALL A	HALL A: Connection to X101, pin 11
	2		
	3	HALL B	HALL B: Connection to X101, pin 12
	4	HALL C	HALL C: Connection to X101, pin 13
	5	—	—
	6	—	—
	7	—	—
	8	0 V DGND	Reference potential

Tab. 236: X302 connection description for single-ended TTL hall sensors

#### Connecting wiring

For the connecting wiring, note the [FK-MCP 1,5 -ST-3,5](#) [▶ 430] terminal specification.

#### Cable requirements

Feature	All sizes
Max. cable length	30 m

Tab. 237: Cable length [m]

### 11.10.1.5 X303: 24 V supply

The connection of 24 V<sub>DC</sub> to X303 is required for supplying the adapter box.

Electrical data	Value
U <sub>1</sub>	24 V <sub>DC</sub> +20%/–15%
I <sub>1max</sub>	100 mA

Tab. 238: Electrical data

	Pin	Designation	Function
 1   2	1	+	24 V <sub>DC</sub> supply
	2	–	Reference potential for +24 V <sub>DC</sub>

Tab. 239: X303 connection description

#### Connecting wiring

For the connecting wiring, obey the terminal specification [BFL 5.08HC 180 SN](#) [▶ 428].

**Cable requirements**

Feature	All sizes
Max. cable length	30 m

Tab. 240: Cable length [m]

**11.10.1.6 X304: Encoder and Hall sensor via D-sub**

Connect the differential TTL incremental encoder to the single-ended TTL Hall sensor at X304 using a D-sub connector.

Observe the technical data for the X304 connection (see [X304](#), [X305](#), [X306](#) [▶ 74]).

 **WARNING!**

**Injury to persons and material damage due to electrical voltage!**

There is no potential isolation in the LA6 adapter box.

- Signals from motor temperature sensors without potential isolation may not be routed using the LA6 and must be connected directly to the drive controller instead (terminal X2).

**Differential TTL incremental encoders with single-ended TTL Hall sensor**

Socket	Pin	Designation	Function
 <p>8 7 6 5 4 3 2 1 15 14 13 12 11 10 9</p>	1	HALL A	HALL A
	2	U <sub>2</sub>	Encoder supply
	3	N –	Inverse differential input for N channel
	4	B –	Inverse differential input for B channel
	5	A –	Inverse differential input for A channel
	6	U <sub>2</sub> Sense	Sense connection for regulating the encoder supply
	7	—	—
	8	—	—
	9	HALL B	HALL B
	10	0 V GND	Reference potential for encoder supply to pin 2
	11	N +	Differential input for N channel
	12	B +	Differential input for B channel
	13	A +	Differential input for A channel
	14	HALL C	HALL C
	15	—	—

Tab. 241: X304 connection description for differential TTL incremental encoder with single-ended TTL Hall sensor

**Cable requirements**

Feature	All sizes
Max. cable length, in total (motor to adapter box to drive controller)	100 m, shielded

Tab. 242: Cable length [m]

### 11.10.1.7 X305, X306: Encoder and Hall sensor via loose cable ends

At X305 and X306, you can alternatively connect the differential TTL incremental encoder with the single-ended TTL Hall sensor using loose cable ends.

Observe the technical data for the X305 and X306 connection (see [X304, X305, X306](#) [▶ 74]).

#### Differential TTL incremental encoders with single-ended TTL Hall sensor

Terminal	Pin	Designation	Function
 1 2 3 4 5 6 7 8 9	1	HALL A	HALL A
	2	U <sub>2</sub>	Encoder supply
	3	N –	Inverse differential input for N channel
	4	B –	Inverse differential input for B channel
	5	A –	Inverse differential input for A channel
	6	U <sub>2</sub> Sense	Sense connection for regulating the encoder supply
	7	—	—
	8	—	—
	9	HALL B	HALL B

Tab. 243: X305 connection description for differential incremental encoder with single-ended TTL Hall sensor

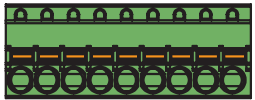
Terminal	Pin	Designation	Function
 1 2 3 4 5 6 7 8 9	1	0 V GND	Reference potential for encoder supply
	2	N +	Differential input for N channel
	3	B +	Differential input for B channel
	4	A +	Differential input for A channel
	5	HALL C	HALL C
	6	—	—
	7	—	—
	8	—	—
	9	—	—

Tab. 244: X306 connection description for differential TTL incremental encoder with single-ended TTL Hall sensor

#### Connecting wiring

For the connecting wiring, note the [FK-MCP 1,5 -ST-3,5](#) [▶ 430] terminal specification.

#### Cable requirements

Feature	All sizes
Max. cable length, in total (motor to adapter box to drive controller)	100 m, shielded

Tab. 245: Cable length [m]

## 11.11 Cables

Note that the motor, cables and drive controller each have electrical properties which influence one another. Unfavorable combinations could possibly result in impermissible voltage peaks on the motor and drive controller and increased wear as a result.

Take into consideration the following instructions when selecting suitable cables:

- Cable cross-sections for connection to the motor:  
Note the permitted stall current  $I_0$  for the motor when making your selection.
- Conductor cross-sections for the power connection:  
Note the line fuse, the maximum permitted conductor cross-section for terminal X10, the routing method and the surrounding temperature when making your selection.
- Also pay attention to the trailing and torsional strength of the lines.
- When using a motor brake, pay attention to the voltage drop in the supply voltage on the line.

### Information

To ensure proper functionality, we recommend using cables from STOBER that are matched to the complete system. If unsuitable cables are used, we reserve the right to reject claims under the warranty.

### Information

Please observe the motor connection diagram that is delivered with every STOBER motor.

### 11.11.1 Power cables

Synchronous servo motors and Lean motors from STOBER are equipped with plug connectors as standard, while asynchronous motors are equipped with terminal boxes.

STOBER provides suitable cables in various lengths, conductor cross-sections and connector sizes.

#### 11.11.1.1 Connection description

Depending on the size of the motor plug connector, power cables are available in the following designs:

- Quick lock for con.15
- speedtec quick lock for con.23 and con.40
- Screw technology for con.58

Motor-side connection

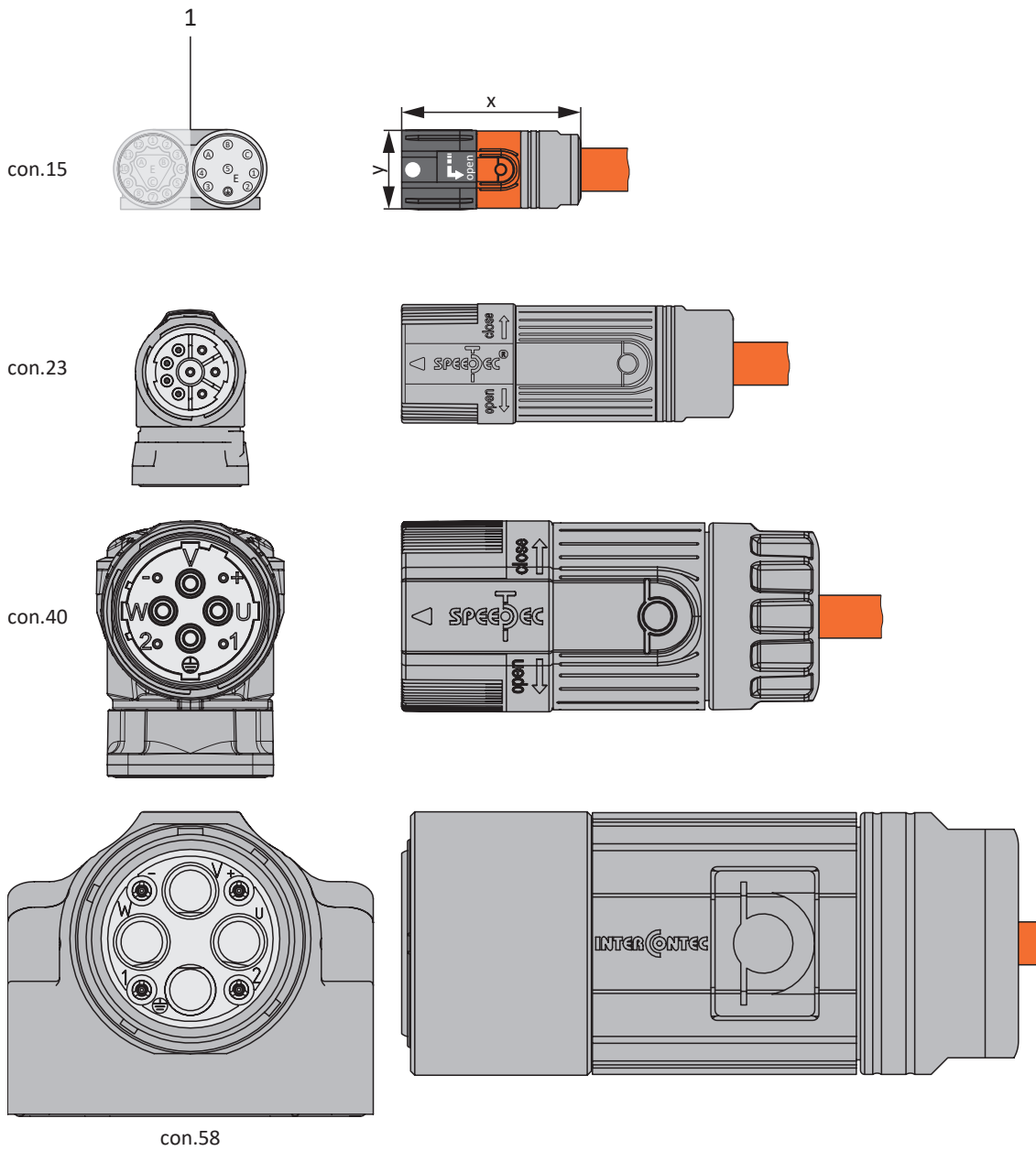

1 Plug connectors

**Drive controller-side connection**

Sizes 0 to 2

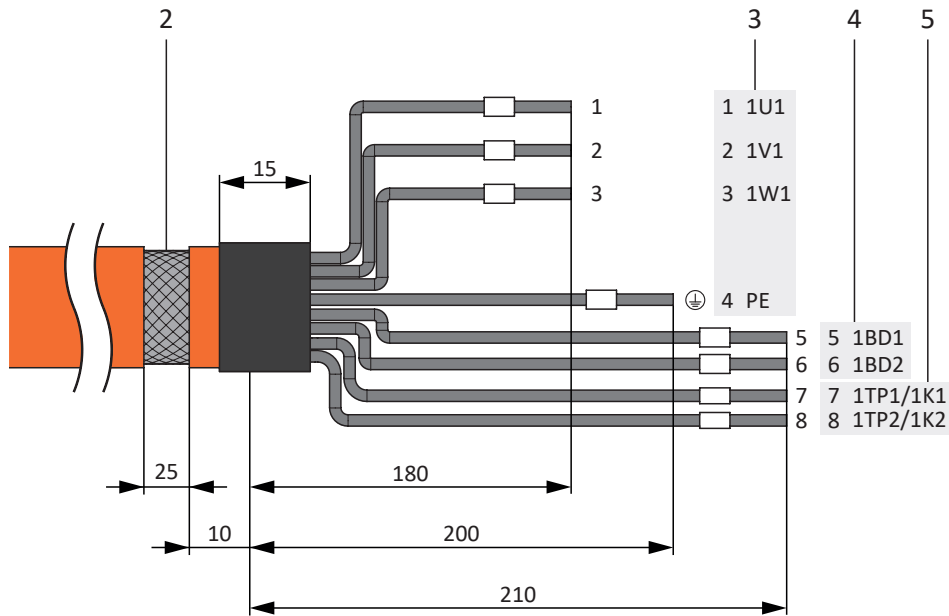

Size 3

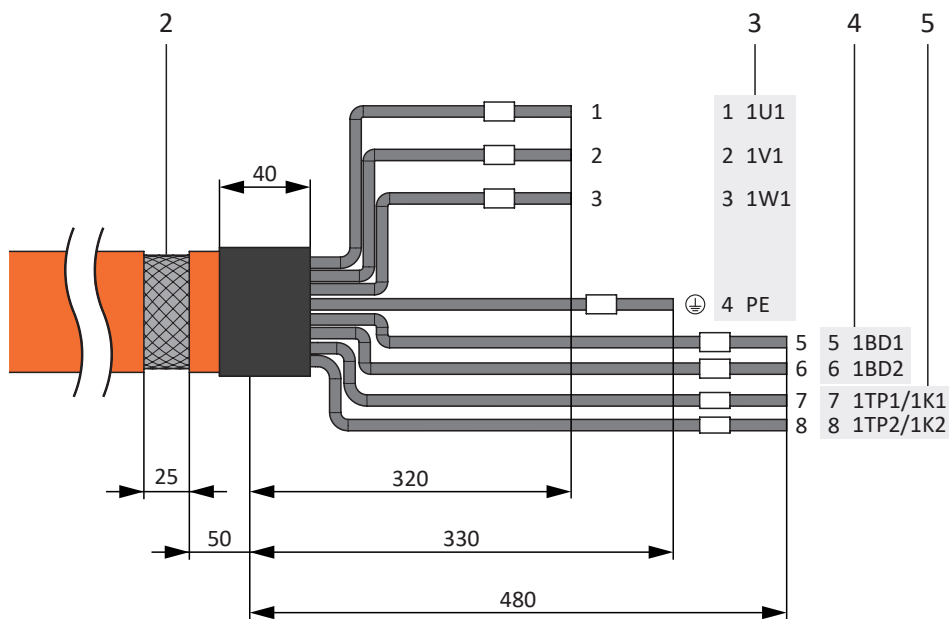

- 2 Power cable with cable shield and shrink tube
- 3 Connection to terminal X20, motor
- 4 Connection of terminal X5, brake
- 5 Connection to terminal X2, temperature sensor

Motor type	Connection	Size 0 to 2	Size 3
Synchronous servo motor, asynchronous motor	Without output choke	50 m, shielded	100 m, shielded
Synchronous servo motor, asynchronous motor	With output choke	100 m, shielded	—

Tab. 246: Maximum cable length of the power cable [m]

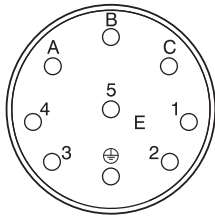

## Power cables – con.15 plug connector

Motor connection diagram	Motor (1)			Cable (2)	Drive controller (3) – (5)		
	Pin	Designation	Int. motor Core color	Core No./ Core color	Pin X20	Pin X5	Pin X2
	A	1U1	BK	1	1	—	—
	B	1V1	BU	2	2	—	—
	C	1W1	RD	3	3	—	—
	1	1TP1/1K1	BK/RD/BN <sup>a)</sup>	7	—	—	7
	2	1TP2/1K2	WH <sup>a)</sup>	8	—	—	8
	3	1BD1	RD	5	—	5	—
	4	1BD2	BK	6	—	6	—
	5	—	—	—	—	—	—
	⊕	PE	GNYE	GNYE	4	—	—
	Housing	Shield	—	—	Shield contact	—	—

Tab. 247: con.15 power cable pin assignment

a) Color depends on the type of temperature sensor (PTC/Pt1000/KTY), which is specified on the motor nameplate.

Length x [mm]	Diameter y [mm]
42	18.7

Tab. 248: con.15 connector dimensions

## Power cables – con.23 plug connectors

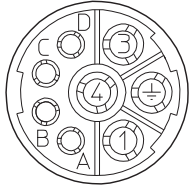
Motor connection diagram	Motor (1)			Cable (2)	Drive controller (3) – (5)		
	Pin	Designation	Int. motor Core color	Core No./ Core color	Pin X20	Pin X5	Pin X2
	1	1U1	BK	1	1	—	—
	3	1V1	BU	2	2	—	—
	4	1W1	RD	3	3	—	—
	A	1BD1	BK/RD <sup>a)</sup>	5	—	5	—
	B	1BD2	BK	6	—	6	—
	C	1TP1/1K1	BK/RD/BN <sup>b)</sup>	7	—	—	7
	D	1TP2/1K2	WH <sup>b)</sup>	8	—	—	8
	⊕	PE	GNYE	GNYE	4	—	—
	Housing	Shield	—	—	Shield contact	—	—

Tab. 249: con.23 power cable pin assignment

a) Color depends on the type of motor

b) Color depends on the type of temperature sensor (PTC/Pt1000/KTY) which is specified on the motor nameplate.

Length x [mm]	Diameter y [mm]
78	26

Tab. 250: con.23 connector dimensions

**Power cables – con.40 plug connector**

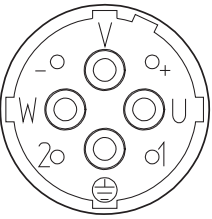
Motor (1)				Cable (2)	Drive controller (3) – (5)		
Motor connection diagram	Pin	Designation	Int. motor Core color	Core No./ Core color	Pin X20	Pin X5	Pin X2
	U	1U1	BK	1	1	—	—
	V	1V1	BU	2	2	—	—
	W	1W1	RD	3	3	—	—
	+	1BD1	RD	5	—	5	—
	-	1BD2	BK	6	—	6	—
	1	1TP1/1K1	BK/RD/BN <sup>a)</sup>	7	—	—	7
	2	1TP2/1K2	WH <sup>a)</sup>	8	—	—	8
	⊕	PE	GNYE	GNYE	4	—	—
	Housing	Shield	—	—	Shield contact	—	—

Tab. 251: con.40 power cable pin assignment

a) Color depends on the type of temperature sensor (PTC/Pt1000/KTY), which is specified on the motor nameplate.

Length x [mm]	Diameter y [mm]
99	46

Tab. 252: con.40 connector dimensions

**Power cables – con.58 plug connector**

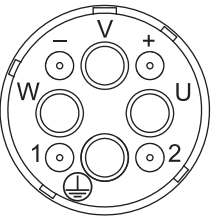
Motor (1)				Cable (2)	Drive controller (3) – (5)		
Motor connection diagram	Pin	Designation	Int. motor Core color	Core No./ Core color	Pin X20	Pin X5	Pin X2
	U	1U1	BK	1	1	—	—
	V	1V1	BU	2	2	—	—
	W	1W1	RD	3	3	—	—
	+	1BD1	RD	5	—	5	—
	-	1BD2	BK	6	—	6	—
	1	1TP1/1K1	BK/RD/BN <sup>a)</sup>	7	—	—	7
	2	1TP2/1K2	WH <sup>a)</sup>	8	—	—	8
	⊕	PE	GNYE	GNYE	4	—	—
	Housing	Shield	—	—	Shield contact	—	—

Tab. 253: con.58 power cable pin assignment

a) Color depends on the type of temperature sensor (PTC/Pt1000/KTY), which is specified on the motor nameplate.

Length x [mm]	Diameter y [mm]
146	63.5

Tab. 254: con.58 connector dimensions

## 11.11.2 Encoder cables

STOBER motors are equipped with encoder systems and plug connectors as standard.

STOBER provides suitable cables in various lengths, conductor cross-sections and connector sizes.

Depending on the respective motor types, different encoder systems can be used.

### 11.11.2.1 EnDat 2.1/2.2 digital encoders

Suitable encoder cables are described below.

#### 11.11.2.1.1 Connection description

Depending on the size of the motor plug connector, encoder cables are available in the following designs:

- Quick lock for con.15
- speedtec quick lock for con.17 and con.23

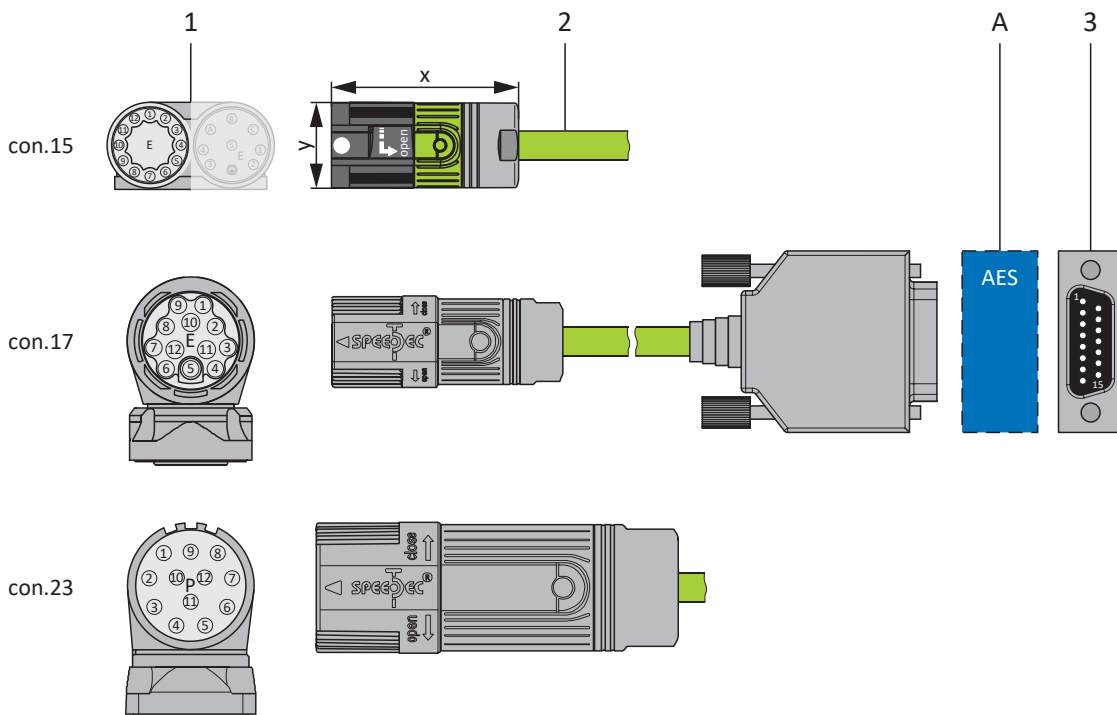

- 1 Plug connectors
- 2 STOBER encoder cable
- A Only con.15 and con.17: Optional Absolute Encoder Support (AES) battery module
- 3 D-sub X4/X140

### Encoder cables – con.15 plug connectors

The power supply is buffered for EnDat 2.2 digital "EBI 1135" and "EBI 135" inductive encoders with a multi-turn function. In this case, pin 2 and pin 3 of the motor are assigned to the  $U_{2BAT}$  buffer battery. Note that the encoder cable must not be connected to the encoder interface of the drive controller, but rather to the AES battery module for these encoders.

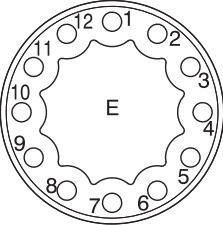
Connection diagram	Motor (1)			Cable (2)	Drive controller (3)
	Pin	Designation	Core color	Core color	Pin X4/X140
	1	Clock +	VT	YE	8
	2	$U_2$ Sense	BNGN	PK	12
		$U_{2BAT+}$ <sup>44</sup>	BU		
	3	—	—	GY	3
		$U_{2BAT-}$ <sup>45</sup>	WH		
	4	—	—	—	—
	5	Data -	PK	BN	13
	6	Data +	GY	WH	5
	7	—	—	—	—
	8	Clock -	YE	GN	15
	9	—	—	—	—
	10	0 V GND	WHGN	BU	2
	11	—	—	—	—
	12	$U_2$	BNGN	RD	4
Housing	Shield	—	—	Housing	

Tab. 255: con.15 encoder cable pin assignment, EnDat 2.1/2.2 digital

Length x [mm]	Diameter y [mm]
42	18.7

Tab. 256: con.15 connector dimensions

<sup>44</sup> Only relevant for EBI encoders

<sup>45</sup> Only relevant for EBI encoders

**Encoder cables – con.17 plug connectors**

The power supply is buffered for EnDat 2.2 digital "EBI 1135" and "EBI 135" inductive encoders with a multi-turn function. In this case, pin 2 and pin 3 of the motor are assigned to the  $U_{2BAT}$  buffer battery. Note that the encoder cable must not be connected to the encoder interface of the drive controller, but rather to the AES battery module for these encoders.

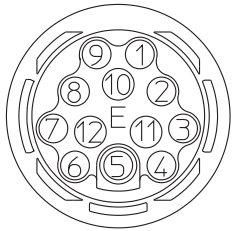
Motor (1)				Cable (2)	Drive controller (3)
Connection diagram	Pin	Designation	Core color	Core color	Pin X4/X140
	1	Clock +	VT	YE	8
	2	$U_2$ Sense	BNGN	PK	12
		$U_{2BAT+}$ <sup>46</sup>	BU		
	3	—	—	GY	3
		$U_{2BAT-}$ <sup>47</sup>	WH		
	4	—	—	—	—
	5	Data –	PK	BN	13
	6	Data +	GY	WH	5
	7	—	—	—	—
	8	Clock –	YE	GN	15
	9	—	—	—	—
	10	0 V GND	WHGN	BU	2
	11	—	—	—	—
	12	$U_2$	BNGN	RD	4
Housing	Shield	—	—	Housing	

Tab. 257: con.17 encoder cable pin assignment, EnDat 2.1/2.2 digital

Length x [mm]	Diameter y [mm]
56	22

Tab. 258: con.17 connector dimensions

<sup>46</sup> Only relevant for EBI encoders

<sup>47</sup> Only relevant for EBI encoders

**Encoder cables – con.23 plug connector**

Connection diagram	Motor (1)			Cable (2)	Drive controller (3)
	Pin	Designation	Core color	Core color	Pin X4/X140
	1	Clock +	VT	YE	8
	2	U <sub>2</sub> Sense	BNGN	PK	12
	3	—	—	—	—
	4	—	—	—	—
	5	Data -	PK	BN	13
	6	Data +	GY	WH	5
	7	—	—	—	—
	8	Clock -	YE	GN	15
	9	—	—	—	—
	10	0 V GND	WHGN	BU	2
	11	—	—	—	—
	12	U <sub>2</sub>	BNGN	RD	4
	Housing	Shield	—	—	Housing

Tab. 259: con.23 encoder cable pin assignment, EnDat 2.1/2.2 digital

Length x [mm]	Diameter y [mm]
58	26

Tab. 260: con.23 dimensions

### 11.11.2.2 SSI encoders

Suitable encoder cables are described below.

#### 11.11.2.2.1 Connection description

The encoder cable is available in plug connector size con.23 with a speedtec quick lock.

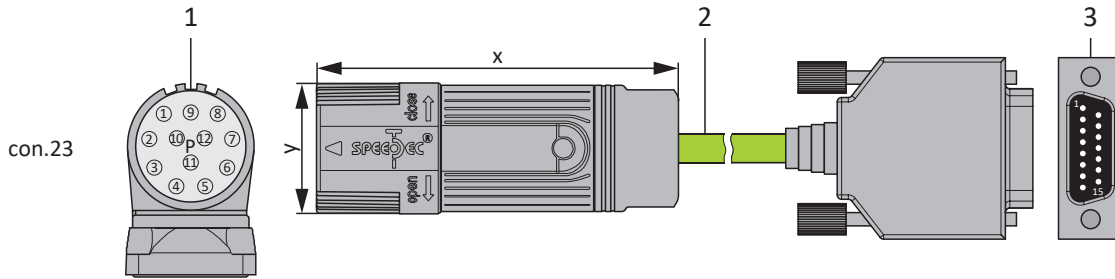

- 1 Plug connectors
- 2 STOBER encoder cable
- 3 D-sub X4

#### Encoder cables – con.23 plug connectors

Connection diagram	Motor (1)			Cable (2)	Drive controller (3)
	Pin	Designation	Core color	Core color	Pin X4
	1	Clock +	VT	YE	8
	2	U <sub>2</sub> Sense	BNGN	PK	12
	3	—	—	—	—
	4	—	—	—	—
	5	Data –	PK	BN	13
	6	Data +	GY	WH	5
	7	—	—	—	—
	8	Clock –	YE	GN	15
	9	—	—	—	—
	10	0 V GND	WHGN	BU	2
	11	—	—	—	—
	12	U <sub>2</sub>	BNGN	RD	4
	Housing	Shield	—	—	Housing

Tab. 261: con.23 encoder cable pin assignment, SSI

Length x [mm]	Diameter y [mm]
58	26

Tab. 262: con.23 dimensions

### 11.11.2.3 Differential HTL incremental encoders

Suitable encoder cables are described below.

#### 11.11.2.3.1 Connection description

The encoder cable is available in plug connector size con.23 with a speedtec quick lock.

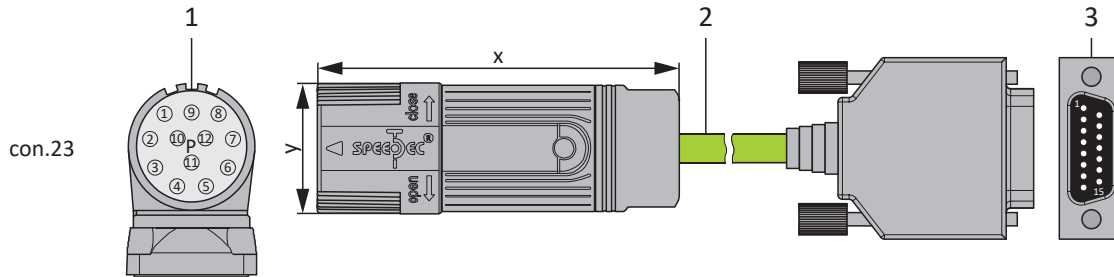

- 1 Plug connectors
- 2 STOBER encoder cable
- 3 D-sub X4

#### Encoder cables – con.23 plug connectors

Connection diagram	Motor (1)				Cable (2)	Drive controller (3)
	Pin	Designation	Core color up to size 80	Core color size 90 or larger	Core color	Pin X4
	1	B -	PK	BK	YE	9
	2	—	—	YE	—	—
	3	N +	BU	PK	PK	3
	4	N -	RD	WH	GY	10
	5	A +	GN	GN	BN	6
	6	A -	YE	GN	WH	11
	7	—	—	—	—	—
	8	B +	GY	GY	GN	1
	9	—	—	—	—	—
	10	0 V GND	WH	BU	BU	2 <sup>48</sup>
	11	—	—	VT	—	—
	12	U <sub>2</sub>	BN	RD	RD	4
Housing	Shield	—	—	—	Housing	

Tab. 263: con.23 encoder cable pin assignment, incremental HTL

Length x [mm]	Diameter y [mm]
58	26

Tab. 264: con.23 dimensions

<sup>48</sup> Pin 12 (U<sub>2</sub> Sense) with pin 2 (0 V GND) bridged: The bridge is constructed in the cable connector that is connected to X4.



### 11.11.2.4 Differential TTL incremental encoders

The encoder cable appropriate for connecting a differential TTL incremental encoder with a single-ended TTL Hall sensor to the LA6 adapter box is described below.

#### 11.11.2.4.1 Connection description

The encoder cable is available in plug connector size con.17 with a speedtec quick lock.

#### Encoder cables – con.17 plug connectors

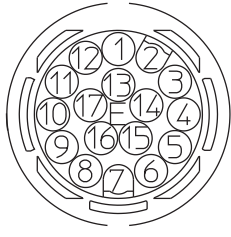
Connection diagram	Motor		Cables	Adapter box
	Pin	Designation	Core color	Pin X304
	1	A -	YE	5
	2	B -	OG	4
	3	N +	BU	11
	4	U <sub>2</sub>	BNRD	2
	5	Sense	BNYE	6
	6	—	—	—
	7	—	—	—
	8	—	—	—
	9	A +	GN	13
	10	B +	RD	12
	11	N -	GY	3
	12	0 V GND	BNBU	10
	13	—	—	—
	14	HALL A	GNRD	1
	15	—	—	—
	16	HALL B	GNBK	9
	17	HALL C	BNGY	14
Housing	Shield	—	Housing	

Tab. 265: con.17 encoder cable pin assignment

Length x [mm]	Diameter y [mm]
56	22

Tab. 266: con.17 connector dimensions

### 11.11.2.5 Resolver

Suitable encoder cables are described below.

#### 11.11.2.5.1 Connection description

Depending on the size of the motor plug connector, encoder cables are available in the following designs:

- Quick lock for con.15
- speedtec quick lock for con.17 and con.23

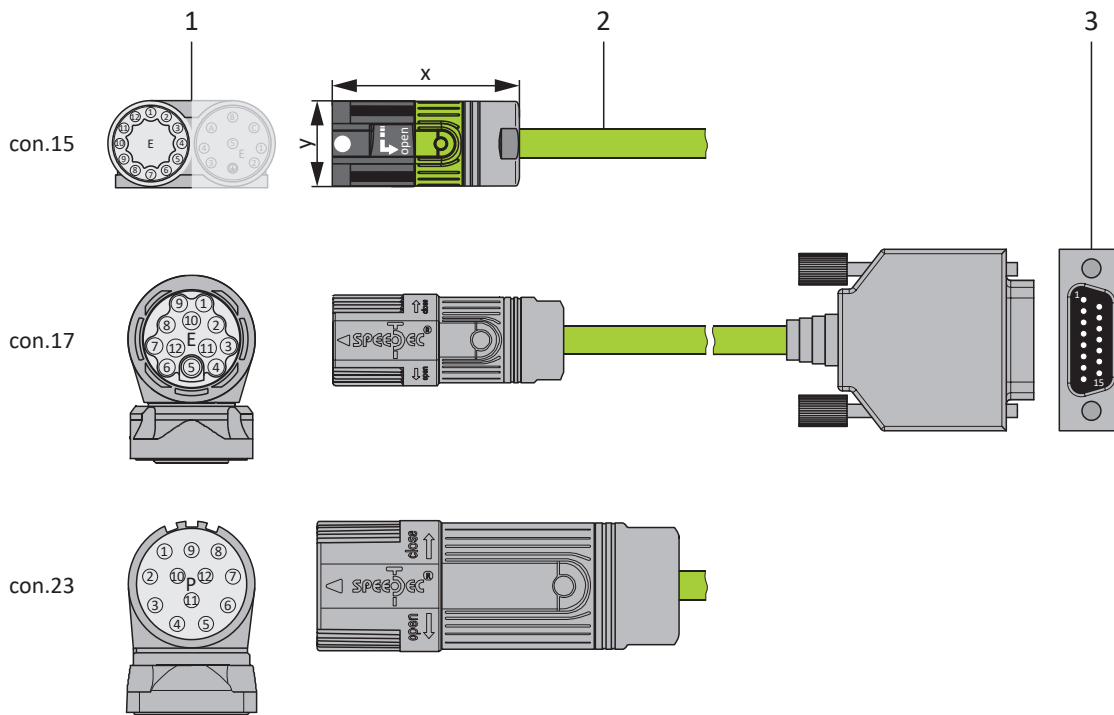

- 1 Plug connectors
- 2 STOBER encoder cable
- 3 D-sub X140

#### Information

Note that the cores for the temperature sensor in STOBER are routed in the power cable as standard. For motors that provide the temperature sensor at the encoder connection, you need an interface adapter to lead out the temperature sensor cores for connecting the cable to the drive controller.

#### Information

For connecting STOBER resolver cables with a 9-pin D-sub connector, such as the standard design for ED/EK synchronous servo motors, you must use the AP6A00 (ID No. 56498) or AP6A01 (ID No. 56522) interface adapter, available separately.

**Encoder cables – con.15 plug connectors**

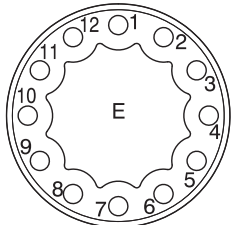
Connection diagram	Motor (1)			Cable (2)	Drive controller (3)
	Pin	Designation	Core color	Core color	Pin X140
	1	S3 Cos +	BK	YE	3
	2	S1 Cos -	RD	GN	11
	3	S4 Sin +	BU	WH	1
	4	S2 Sin -	YE	BN	9
	5	1TP1	BK	RD	7
	6	1TP2	WH	BU	14
	7	R2 Ref +	YEW/ BKWH	GY	6
	8	R1 Ref -	RDWH	PK	2
	9	—	—	—	—
	10	—	—	—	—
	11	—	—	—	—
	12	—	—	—	—
	Housing	Shield	—	—	Housing

Tab. 267: con.15 encoder cable pin assignment, resolver

Length x [mm]	Diameter y [mm]
42	18.7

Tab. 268: con.15 connector dimensions

**Encoder cables – con.17 plug connectors**

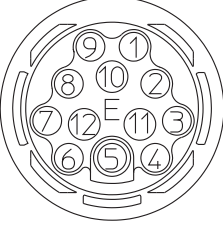
Connection diagram	Motor (1)			Cable (2)	Drive controller (3)
	Pin	Designation	Core color	Core color	Pin X140
	1	S3 Cos +	BK	YE	3
	2	S1 Cos –	RD	GN	11
	3	S4 Sin +	BU	WH	1
	4	S2 Sin –	YE	BN	9
	5	1TP1	BK	RD	7
	6	1TP2	WH	BU	14
	7	R2 Ref +	YEW/ BKWH	GY	6
	8	R1 Ref –	RDWH	PK	2
	9	–	–	–	–
	10	–	–	–	–
	11	–	–	–	–
	12	–	–	–	–
	Housing	Shield	–	–	Housing

Tab. 269: con.17 encoder cable pin assignment, resolver

Length x [mm]	Diameter y [mm]
56	22

Tab. 270: con.17 connector dimensions

**Encoder cables – con.23 plug connectors**

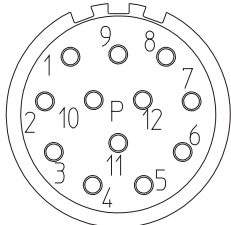
Connection diagram	Motor (1)			Cable (2)	Drive controller (3)
	Pin	Designation	Core color	Core color	Pin X140
	1	S3 Cos +	BK	YE	3
	2	S1 Cos -	RD	GN	11
	3	S4 Sin +	BU	WH	1
	4	S2 Sin -	YE	BN	9
	5	1TP1	BK	RD	—
	6	1TP2	WH	BU	—
	7	R2 Ref +	YEW/ BKWH	GY	6
	8	R1 Ref -	RDWH	PK	2
	9	—	—	—	—
	10	—	—	—	—
	11	—	—	—	—
	12	—	—	—	—
	Housing	Shield	—	—	Housing

Tab. 271: con.23 encoder cable pin assignment, resolver

Length x [mm]	Diameter y [mm]
58	26

Tab. 272: con.23 dimensions

### 11.11.2.6 EnDat 2.1 sin/cos encoders

Suitable encoder cables are described below.

#### 11.11.2.6.1 Connection description

Depending on the size of the motor plug connector, encoder cables are available in the following designs:

- Quick lock for con.15
- speedtec quick lock for con.17 and con.23

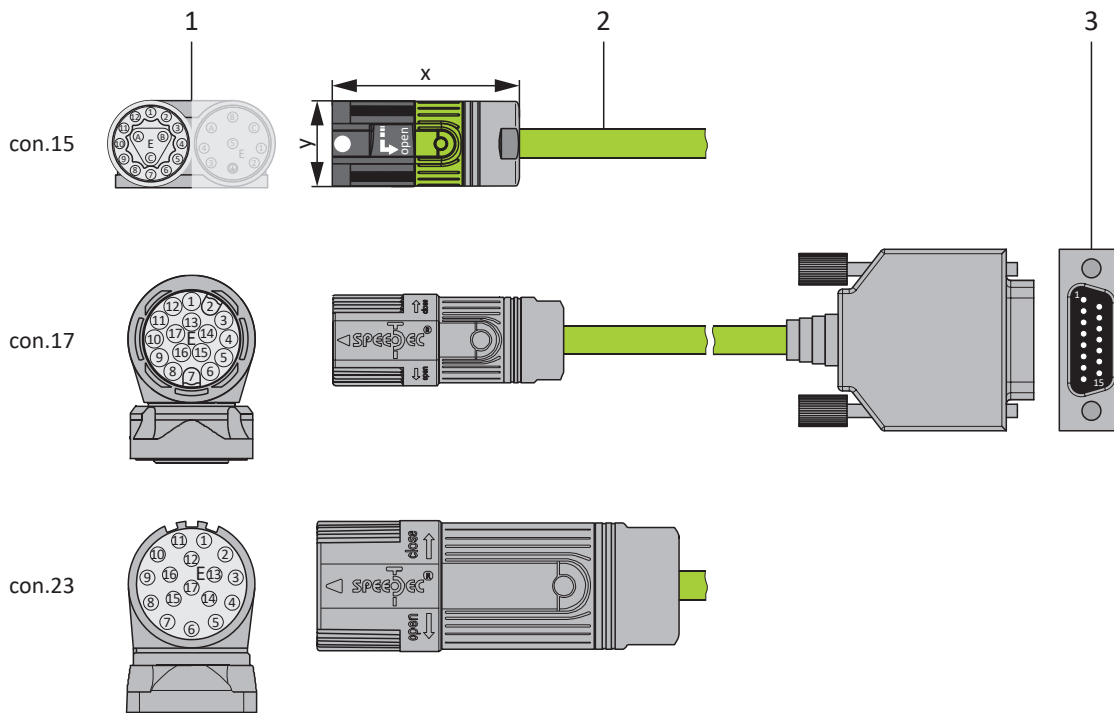

- 1 Plug connectors
- 2 STOBER encoder cable
- 3 D-sub X140

#### Information

Note that the cores for the temperature sensor in STOBER are routed in the power cable as standard. For motors that provide the temperature sensor at the encoder connection, you need an interface adapter to lead out the temperature sensor cores for connecting the cable to the drive controller.

#### Information

For connecting STOBER EnDat 2.1 sin/cos cables with a 15-pin D-sub connector to an integrated motor temperature sensor, you must use the AP6A02 interface adapter (ID No. 56523), available separately, to lead out the temperature sensor cores.

Encoder cables – con.15 plug connectors

Connection diagram	Motor (1)			Cable (2)	Drive controller (3)
	Pin	Designation	Core color	Core color	Pin X140
	1	U <sub>2</sub> Sense	BU	GNRD	12
	2	0 V Sense	WH	GNBK	10
	3	U <sub>2</sub>	BNGN	BNRD	4
	4	Clock +	VT	WHBK	8
	5	Clock –	YE	WHYE	15
	6	0 V GND	WHGN	BNBU	2
	7	B + (Sin +)	BUBK	RD	9
	8	B – (Sin –)	RDBK	OG	1
	9	Data +	GY	GY	5
	10	A + (Cos +)	GNBK	GN	11
	11	A – (Cos –)	YEBK	YE	3
	12	Data –	PK	BU	13
	A	1TP2	WH	BNGY	14
	B	1TP1	BK	BNYE	7
	C	—	—	—	—
	Housing	Shield	—	—	Housing

Tab. 273: con.15 encoder cable pin assignment, EnDat 2.1 sin/cos

Length x [mm]	Diameter y [mm]
42	18.7

Tab. 274: con.15 connector dimensions

**Encoder cables – con.17 plug connectors**

Connection diagram	Motor (1)			Cable (2)	Drive controller (3)
	Pin	Designation	Core color	Core color	Pin X140
	1	U <sub>2</sub> Sense	BU	GNRD	12
	2	—	—	—	—
	3	—	—	—	—
	4	0 V Sense	WH	GNBK	10
	5	1TP2	WH	BNGY	14
	6	1TP1	BK	BNYE	7
	7	U <sub>2</sub>	BNGN	BNRD	4
	8	Clock +	VT	WHBK	8
	9	Clock –	YE	WHYE	15
	10	0 V GND	WHGN	BNBU	2
	11	—	—	—	—
	12	B + (Sin +)	BUBK	RD	9
	13	B – (Sin –)	RDBK	OG	1
	14	Data +	GY	GY	5
	15	A + (Cos +)	GNBK	GN	11
	16	A – (Cos –)	YEBK	YE	3
	17	Data –	PK	BU	13
Housing	Shield	—	—	Housing	

Tab. 275: con.17 encoder cable pin assignment, EnDat 2.1 sin/cos

Length x [mm]	Diameter y [mm]
56	22

Tab. 276: con.17 connector dimensions

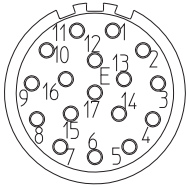

Encoder cables – con.23 plug connectors

Connection diagram	Motor (1)			Cable (2)	Drive controller (3)
	Pin	Designation	Core color	Core color	Pin X140
	1	U <sub>2</sub> Sense	BU	GNRD	12
	2	—	—	—	—
	3	—	—	—	—
	4	0 V Sense	WH	GNBK	10
	5	1TP2	WH	BNGY	14
	6	1TP1	BK	BNYE	7
	7	U <sub>2</sub>	BNGN	BNRD	4
	8	Clock +	VT	WHBK	8
	9	Clock –	YE	WHYE	15
	10	0 V GND	WHGN	BNBU	2
	11	—	—	—	—
	12	B + (Sin +)	BUBK	RD	9
	13	B – (Sin –)	RDBK	OG	1
	14	Data +	GY	GY	5
	15	A + (Cos +)	GNBK	GN	11
	16	A – (Cos –)	YEBK	YE	3
	17	Data –	PK	BU	13
Housing	Shield	—	—	Housing	

Tab. 277: con.23 encoder cable pin assignment, EnDat 2.1 sin/cos

Length x [mm]	Diameter y [mm]
58	26

Tab. 278: con.23 dimensions









## 12 Operation

The operating unit of the drive controller consists of a graphic display (LCD) and buttons.

### 12.1 Overview



Fig. 55: Operating unit of the SD6 drive controller

	Select levels, parameter groups and parameters or apply modified parameter values
	Display parameters of the start display, navigate to a previous level, reject modified parameter values or acknowledge fault
	Select parameters within a parameter group or change parameter values
	
	Select a parameter group or select a character position of a parameter
	
	Activate or deactivate local operation; a deactivation causes the enable signal to be cleared
	Enable drive in local operation, if parameterized
	Store in non-volatile memory: press key for 3 seconds

## 12.2 Menu structure and navigation

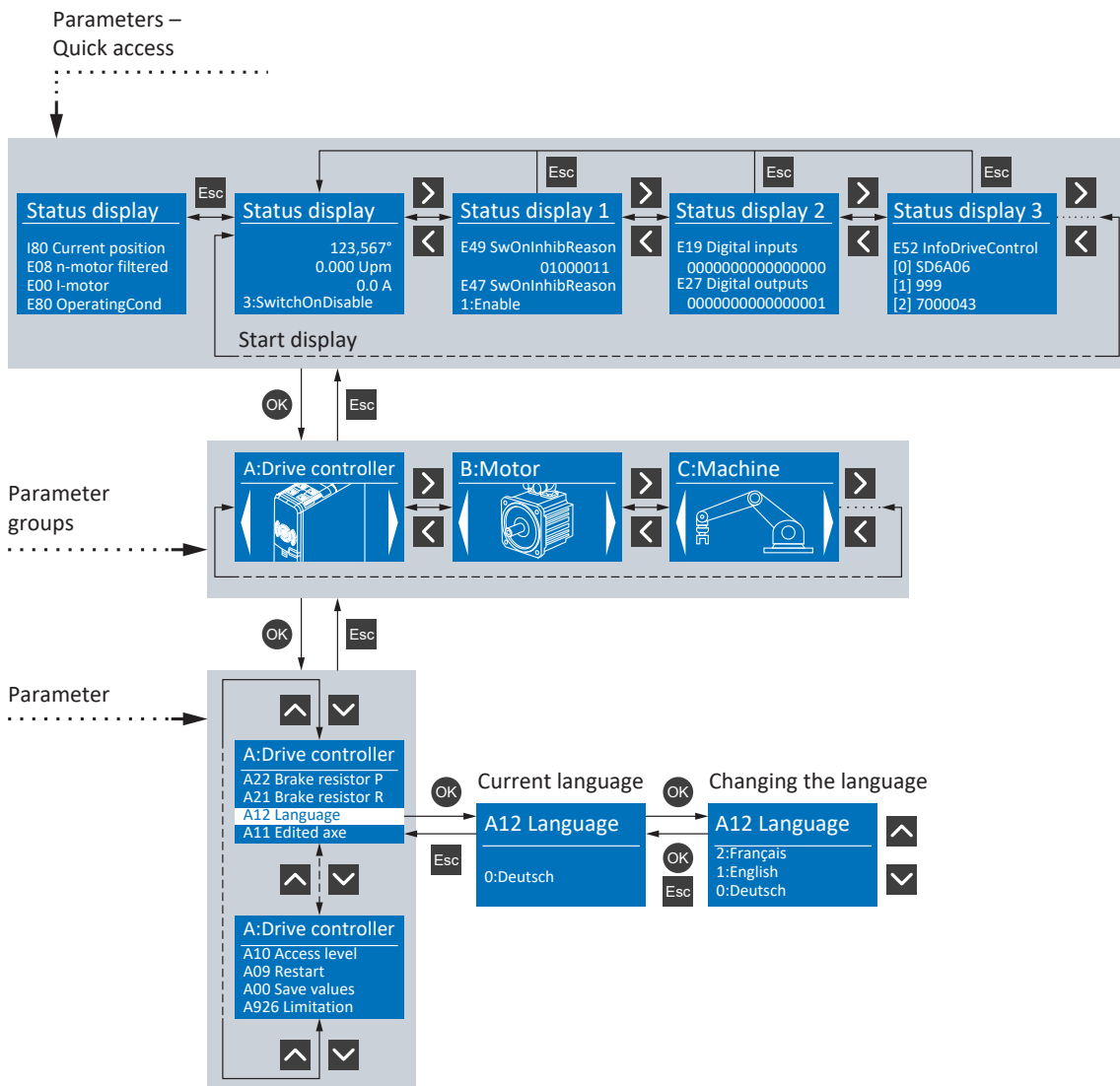

Fig. 56: Menu structure and navigation using the SD6 operating unit

### Parameters – Quick access

Using quick access, you get direct access to the status of the most important (diagnostic) parameters. This level consists of the **STATUS DISPLAY** start display and three additional topic-specific overviews: **STATUS DISPLAY 1**, for example, provides information about the causes of a possible switch-on lockout, **STATUS DISPLAY 2** provides information about analog and digital inputs and outputs, **STATUS DISPLAY 3** provides information about the general data of the drive controller, such as type, firmware, integrated option modules, etc. You can navigate within this level using the left and right arrow keys. You can use the up and down arrow keys to navigate within the current overview to see more information.

For drive controllers with expanded safety technology via the SE6 safety module, a monitoring safety function (e.g. SLI, SLP or SLS) is shown on the display. If a monitoring safety function is active, **STATUS DISPLAY 1** shows the **SAFETY ACTIVE** ticker as long as the status of the safety module = FSRUN (S01, bits 8–15 = 24 hex).

You can access parameters hidden behind the four values on the **STATUS DISPLAY** start display by using [Esc]. These four parameters can be configured individually using parameter A144.

### Parameter groups

Parameters are combined into groups by their functional properties, such as "Drive controller", "Motor", "Machine", "Terminal", etc. You can navigate within this level using the right and left arrow buttons; you can select one of the possible groups with [OK].

### Parameter

Within a parameter group, you can navigate using the up and down arrow buttons; you can select one of the possible parameters with [OK]. If you would like to change a parameter value, select the corresponding character position using the right and left arrow buttons and select the new value using the up and down arrow buttons. You can apply changes with [OK] or reject them with [Esc].

---

<b>Information</b>
--------------------

Note that modified values can be stored in non-volatile memory via an operating unit using the save button or parameter A00.

---

# 13 What you should know before commissioning

The following chapters provide a quick introduction to the structure of the program interface and accompanying window designations as well as relevant information about parameters and generally saving your project configuration.

## 13.1 DS6 program interface

Using the graphical interface of the DriveControlSuite commissioning software (DS6), you can project, parameterize and commission your drive project quickly and efficiently. In case of service, you can evaluate diagnostic information such as operating states, fault memories and fault counters of your drive project using DriveControlSuite.

### Information

The program interface of DriveControlSuite is available in German, English and French. To change the language of the program interface, select Settings > Language.

### Information

The DriveControlSuite help in the menu bar can be reached via Help > Help or via the [F1] key on your keyboard. When you press [F1] in an area of the program, the corresponding help topic opens.

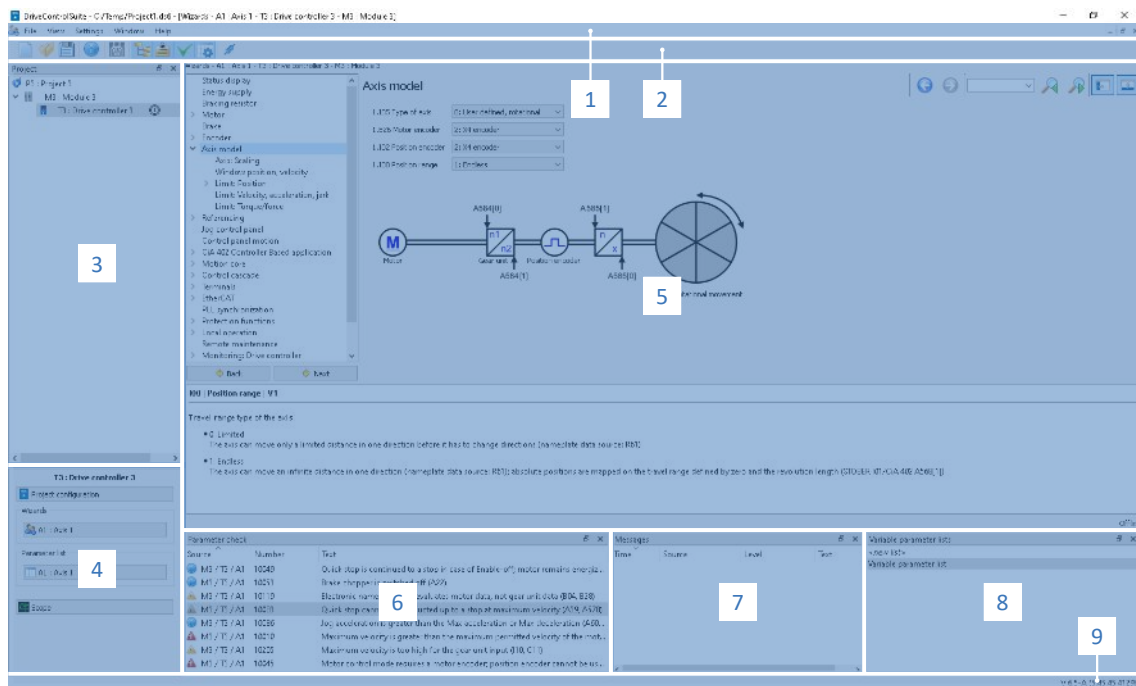

Fig. 57: DS6: Program interface

No.	Area	Description
1	Menu bar	Using the File, View, Settings and Window menus, you can open and save projects, display and hide program windows, select the interface language and access level and change between different windows in the workspace.
2	Toolbar	The toolbar enables quick access to frequently needed functions, like opening and saving projects and hiding and displaying windows in the program interface.
3	Project tree	The project tree forms the structure of your drive project in the form of modules and drive controllers. Select an element using the project tree first in order to edit it using the project menu.
4	Project menu	The project menu offers you various functions for editing the project, module and drive controller. The project menu adapts to the element that you selected in the project tree.
5	Workspace	The different windows which can be used to edit your drive project, such as the configuration dialog, wizards, the parameter list or the scope analysis tool, open in the workspace.
6	Parameter check	The parameter check points out irregularities and inconsistencies that were detected in the plausibility check of calculable parameters.
7	Messages	The entries in the messages log the connection and communication status of the drive controllers, incorrect inputs caught by the system, errors when opening a project or rule violations in the graphical programming.
8	Variable parameter lists	You can use variable parameter lists to compile any parameters in individual parameter lists for a quick overview.
9	Status bar	In the status bar, you can find the specifications of the software version and get additional information about the project file, the devices and the progress of the process during processes such as loading projects.

## 13.2 Meaning of parameters

You can use parameters to adapt the function of the drive controller to your individual application. In addition, parameters visualize the current actual values (actual velocity, actual torque, etc.) and trigger actions such as Save values, Test phase, etc.

### Interpretation of parameter identification

Parameter identification consists of the following elements, where short forms are also possible, i.e. only specifying a coordinate or the combination of coordinate and name.

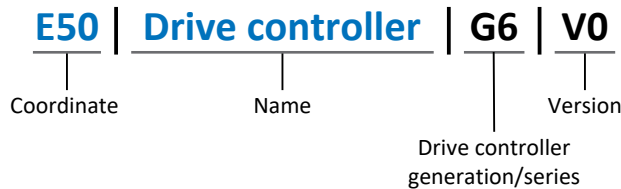

### 13.2.1 Parameter groups

Parameters are assigned to individual groups by topic. The 6th generation of STOBER drive controllers differentiates between the following parameter groups.

Group	Topic
A	Drive controllers, communication, cycle times
B	Motor
C	Machine, velocity, torque/force, comparators
D	Set value
E	Display
F	Terminals, analog and digital inputs and outputs, brake
G	Technology – Part 1 (application-dependent)
H	Encoder
I	Motion (all motion settings)
J	Motion blocks
K	Control panel
L	Technology – Part 2 (application-dependent)
M	Profiles (application-dependent)
N	Additional functions (application-dependent; e.g. extended cam control unit)
P	Customer-specific parameters (programming)
Q	Customer-specific parameters, instance-dependent (programming)
R	Production data for the drive controller, motor, brakes, motor adapter, gear unit and geared motor
S	Safety (safety technology)
T	Scope
U	Protection functions
Z	Fault counter

Tab. 279: Parameter groups

## 13.2.2 Parameter types and data types

In addition to topic-based sorting in individual groups, all parameters belong to a certain data type and parameter type. The data type of a parameter is displayed in the parameter list, properties table. The connections between parameter types, data types and their value range can be found in the following table.

Data type	Parameter type	Length	Value range (decimal)
INT8	Integer or selection	1 byte (signed)	-128 – 127
INT16	Integer	2 bytes (1 word, signed)	-32768 – 32767
INT32	Integer or position	4 bytes (1 double word, signed)	-2147483648 – 2147483647
BOOL	Binary number	1 bit (internal: LSB in 1 byte)	0, 1
BYTE	Binary number	1 byte (unsigned)	0 – 255
WORD	Binary number	2 bytes (1 word, unsigned)	0 – 65535
DWORD	Binary number or parameter address	4 bytes (1 double word, unsigned)	0 – 4294967295
REAL32 (single type according to IEE754)	Floating-point number	4 bytes (1 double word, signed)	$-3.40282 \times 10^{38} - 3.40282 \times 10^{38}$
STR8	Text	8 characters	—
STR16	Text	16 characters	—
STR80	Text	80 characters	—

Tab. 280: Parameters: data types, parameter types, possible values

### Parameter types: Use

- Integer, floating-point number  
For general computing processes  
Example: Set and actual values
- Selection  
Numeric value to which a direct meaning is assigned  
Example: Sources for signals or set values
- Binary number  
Bit-oriented parameter information that is collected in binary  
Example: Control and status words
- Position  
Integer combined with associated units and decimal places  
Example: Actual and set values of positions
- Velocity, acceleration, deceleration, jerk  
Floating-point number combined with associated units  
Example: Actual and set values for velocity, acceleration, deceleration, jerk
- Parameter address  
Referencing of a parameter  
Example: In F40 AO1 source, for example, E08 n-motor filtered can be parameterized
- Text  
Outputs or messages



### 13.2.3 Parameter types

The following types of parameters are differentiated.

Parameter type	Description	Example
Simple parameters	Consist of one group and one line with a defined value.	A21 Brake resistor R: Value = 100 ohms
Array parameters	Consist of a group, a line and multiple sequential (listed) elements, which have the same properties but different values.	A10 Access level <ul style="list-style-type: none"> <li>▪ A10[0] access level: Value = Access level via operating unit</li> <li>▪ A10[2] access level: Value = Access level via CANopen and EtherCAT</li> <li>▪ A10[4] access level: Value = Access level via PROFINET</li> </ul>
Record parameters	Consist of a group, a line and multiple sequential (listed) elements, which can have different properties and different values.	A00 Save values <ul style="list-style-type: none"> <li>▪ A00[0] Start: Value = Start action</li> <li>▪ A00[1] Progress: Value = Display action progress</li> <li>▪ A00[2] Result: Value = Display action result</li> </ul>

Tab. 281: Parameter types

### 13.2.4 Parameter structure

Every parameter has specific coordinates with the following structure.

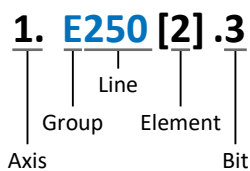

- **Axis (optional)**  
In case of multiple axes, the one to which a parameter is assigned; not applicable for global parameters (value range: 1 – 4).
- **Group**  
The thematic group to which a parameter belongs (value range: A – Z).
- **Line**  
Distinguishes the parameters within a parameter group (value range: 0 – 999).
- **Element (optional)**  
Elements of an array or record parameter (value range: 0 – 16000).
- **Bit (optional)**  
Selection of a single bit for complete data addressing; depends on the data type (value range: 0 – 31).

## 13.2.5 Parameter visibility

The visibility of a parameter is primarily controlled by the access level you set in DriveControlSuite and by the properties you project for the respective drive controller (e.g. hardware, firmware and application). A parameter can also be shown or hidden depending on other parameters or settings. For example, the parameters of an additional function are only shown as soon as you activate the relevant additional function.

### Access level

The access options for the individual software parameters are ranked hierarchically and divided into individual levels. This means that parameters can be hidden for a specific purpose and, relatedly, their configuration options can be locked starting from a specific level.

Each parameter has one access level for read access (visibility) and one access level for write access (editability). The following levels are present:

- Level 0  
Elementary parameters
- Level 1  
Important parameters of an application
- Level 2  
Important parameters for service with extensive diagnostic options
- Level 3  
All parameters needed for commissioning and optimizing an application

The parameter A10 Access level controls general access to parameters:

- Over the SD6 drive controller display (A10[0])
- Over CANopen or EtherCAT (A10[2])
- Over PROFINET (A10[3])

### Information

It is not possible to write to or read the parameter hidden in DriveControlSuite during communication via fieldbus.

### Hardware

Which parameters are available to you in DriveControlSuite is determined by which series you select in the configuration dialog for the drive controller, for example, or whether you project an option module. Basically, the only parameters that are displayed are the ones you need to parameterize the configured hardware.

For example, a drive controller can evaluate an encoder using terminal X120, provided that terminal module XI6 has been installed. The accompanying evaluation is activated using parameter H120. However, this parameter is visible only if terminal module XI6 was initially selected during the drive project configuration.

### Firmware

Due to the further development and updating of functions for the 6th generation of STOBER drive controllers, new parameters and also new versions of existing parameters are continuously being implemented in DriveControlSuite and in the firmware. The parameters are displayed in the software according to the DriveControlSuite version used and the configured firmware version of the respective drive controller.

### Applications

Applications generally differ in terms of functions and their control. For this reason, different parameters are available with each application.

## 13.3 Signal sources and process data mapping

The transmission of control signals and set values in DriveControlSuite meets the following principles.

### Signal sources

Drive controllers are controlled either over a fieldbus, using mixed operation consisting of a fieldbus system and terminals or exclusively using terminals.

You can use the corresponding selection parameters, referred to as signal sources, to configure whether the control signals and set values of the application are obtained over a fieldbus or using terminals.

In case of activation over a fieldbus, parameters that are selected as data sources for control signals or set values must be part of the subsequent process data mapping. In the case of activation using terminals, the respective analog or digital inputs are specified directly.

### Process data mapping

If you are working with a fieldbus system and have selected the source parameters for control signals and set values, configure the fieldbus-specific settings, e.g. the assignment of the process data channels for transmitting receive and transmit process data, as the last step. The respective procedure can be found in the accompanying STOBER fieldbus manuals.

## 13.4 Non-volatile memory

All project configurations, parameterizations and related changes to parameter values are in effect after transmission to the drive controller, but are only stored in volatile memory.

### Saving to a drive controller

To save the configuration in non-volatile memory on a drive controller, you have the following options:

- Saving the configuration using the *Save values wizard*:  
Project menu > Wizards area > Projected axis > Save values wizard: Select the Save values action
- Saving the configuration using the parameter list:  
Project menu > Parameter list area > Projected axis > Group A: Drive controller > A00 Save values: Set the parameter A00[0] to the value 1: Active
- Saving the configuration using the operating unit:  
SD6 drive controller > Operating unit: Press the save button for 3 seconds

### Saving to all drive controllers within a project

To save the configuration in non-volatile memory on several drive controllers, you have the following options:

- Saving the configuration using the toolbar:  
Toolbar > Save values icon: Click the Save values icon
- Saving the configuration using the *Online functions window*:  
Project menu > Online connection button > Online functions window: Click on Save values (A00)

#### Information

Do not shut off the drive controller while saving. If the supply voltage to the control unit is interrupted while saving, the drive controller will start without an executable configuration the next time it is switched on. In this case, the configuration must be transferred to the drive controller again and stored in non-volatile memory.

## 14 Commissioning

The following chapters describe how to commission your drive system using the DriveControlSuite software.

Information on system requirements and software installation can be found in the appendix (see [DriveControlSuite \[▶ 440\]](#)).

For the components of your axis model, **as an example**, we require a STOBER synchronous servo motor with EnDat 2.1/2.2 digital encoder and optional brake. These motors are saved along with all relevant data for the project configuration in the DriveControlSuite motor database and in the electronic nameplate.

Upon selecting the motor from the database, such as when reading out the nameplate, all data is transferred to the corresponding parameters. There is no need for complex parameterization of the motor, brake or encoder.

For STOBER asynchronous motors, the motor data relevant for project configuration is also taken from the motor database. All other motor types need to have their parameters configured manually.

Make sure that the system nodes are wired and supplied with control voltage before commissioning.

### Information

The commissioning process described below is particularly suitable for quick initial commissioning of your drive system with subsequent testing of your projected axis model. Since steps or their sequence may vary depending on the application, refer to the corresponding application manual for detailed information.

### Information

Always perform the steps described below in the specified order!

Some parameters are interdependent and do not become accessible to you until you have first configured certain settings. Follow the steps in the specified sequence so that you can finish the parameterization completely.

## 14.1 Initiating the project

In order to be able to configure all drive controllers and axes of your drive system using DriveControlSuite, you must record them as part of a project.

### 14.1.1 Projecting the drive controller and axis

Create a new project and project the first drive controller along with the accompanying axis.

#### Creating a new project

1. Start DriveControlSuite.
2. On the start screen, click **Create new project**.
  - ⇒ The new project is created and the configuration dialog for the first drive controller opens.
  - ⇒ The **Drive controller** button is active.

## Projecting the drive controller

1. **Properties tab:**  
Establish the relationship between your circuit diagram and the drive controller to be projected in DriveControlSuite.  
Reference: Specify the reference code (equipment code) of the drive controller.  
Designation: Give the drive controller a unique name.  
Version: Version your project configuration.  
Description: If necessary, specify additional supporting information, such as the change history of the project configuration.
2. **Drive controller tab:**  
Select the series and device type of the drive controller.
3. **Option modules tab:**  
Communication module: If the drive controller communicates using a fieldbus with a controller, select the corresponding communication module.  
Terminal module: If you are controlling the drive controller using analog and digital inputs, select the corresponding terminal module (in addition to the communication module in mixed operation).  
Safety module: If the drive controller is part of a safety circuit, select the corresponding safety module.
4. **Device controller tab:**  
Device controller: Select the device controller that defines the underlying activation signals for the drive controller.  
Rx process data, Tx process data: If you use a fieldbus to control the drive controller, select the fieldbus-specific receive and transmit process data.

### Information

Make sure that you project the correct series in the Drive controller tab. The projected series cannot be changed afterwards.

## Projecting the axis

1. Click on Axis 1.
2. **Properties tab:**  
Establish the connection between your circuit diagram and the axis to be projected in DriveControlSuite.  
Reference: Specify the reference code (equipment code) of the axis.  
Designation: Give the axis a unique name.  
Version: Version your project configuration.  
Description: If necessary, specify supporting additional information such as the change history of the project configuration.
3. **Application tab:**  
Select the desired control or drive-based application.
4. **Motor tab:**  
Select the motor category, the series and the type of motor operated using this axis. If you are working with motors from third-party suppliers, enter the accompanying motor data at a later time.
5. Confirm with OK.

## 14.1.2 Configuring safety technology

If the drive controller is part of a safety circuit, you must configure the safety technology in accordance with the commissioning steps outlined in the corresponding manual in the next step (siehe [Detailed information \[► 476\]](#)).

## 14.1.3 Creating other modules and drive controllers

We recommend sorting all drive controllers of your project in DriveControlSuite either functionally by groups and combining a group under a module, or organizing several drive controllers in corresponding modules based on their distribution to different control cabinets.

1. Select your P1 project in the project tree > Context menu **Create new module**.  
⇒ Your M2 module is created in the project tree.
2. Select your M2 module in the project tree > Context menu **Create new drive controller**.  
⇒ Your T2 drive controller is created in the project tree.
3. Mark your T2 drive controller in the project tree.
4. Change to the project menu and click **Project configuration**.
5. Project the drive controller and specify the newly created module.
6. Repeat the steps for all other drive controllers and modules of your project.

## 14.1.4 Projecting the module

Give your module a unique name, enter the reference code and, as an option, store additional information like the version and change history of the module.

1. Select the module in the project tree and click on **Project configuration** in the project menu.  
⇒ The configuration dialog for the module opens.
2. Establish the relationship between your circuit diagram and the module in DriveControlSuite.  
**Reference:** Specify the reference code (equipment code) of the module.  
**Designation:** Give the module a unique name.  
**Version:** Version the module.  
**Description:** If necessary, specify additional supporting information, such as the change history of the module.
3. Confirm with **OK**.

## 14.1.5 Projecting the project

Give your project a unique name, enter the reference code and, as an option, store additional information like the version and change history of the project.

1. Mark the project in the project tree and click on **Project configuration** in the project menu.  
⇒ The configuration dialog for the project opens.
2. Establish the relationship between your circuit diagram and the project in DriveControlSuite.  
**Reference:** Specify the reference code (equipment code) of the project.  
**Designation:** Give the project a unique name.  
**Version:** Version the project.  
**Description:** If necessary, specify additional supporting information, such as the change history of the project.
3. Confirm with **OK**.

## 14.2 Mapping the mechanical axis model

To be able to put your real drive train with one or more drive controllers into operation, you must map your complete mechanical environment in DriveControlSuite.

### 14.2.1 Parameterizing the STOBER motor

You have projected a STOBER synchronous servo motor with EnDat 2.1/2.2 digital encoder and optional brake.

By projecting the corresponding motor, limit values for currents and torques as well as associated temperature data are automatically transferred to the respective parameters of the individual wizards. All additional data on the brake and encoder is transferred at the same time.

#### Motor protection

All models of the 6th STOBER drive controller generation feature an  $i^2t$  model – a computational model for thermal monitoring of the motor. To activate it and set up the protective function, configure the following settings (deviating from the presets): U10 = 2: Warning and U11 = 1.00 s. This model can be used instead of or in addition to temperature-monitored motor protection.

### 14.2.2 Parameterizing the axis model

Parameterize the setup of your drive in this order:

- Define the axis model
- Scale the axis
- Parameterize the position and velocity window
- Limit the axis (optional)
  - Limit the position
  - Limit the velocity, acceleration and jerk
  - Limit the torque and force

### 14.2.2.1 Define the axis model

1. Select the relevant drive controller in the project tree and click on the first projected axis in the Project menu > Wizard area.
2. Select the Axis model wizard.
3. I05 Type of axis:  
Define whether the axis type is rotational or translational.
  - 3.1. If you would like to configure the units of measure and the number of decimal places individually for specifying and displaying positions, velocities, accelerations and jerk, select 0: User defined, rotational or 1: User defined, translational.
  - 3.2. If the units of measure and the number of decimal places for specifying and displaying positions, velocities, accelerations and jerk are to be fixed, select 2: Rotational or 3: Translational.
4. B26 Motor encoder:  
Define the interface to which the motor encoder is connected.
5. I02 Position encoder (optional):  
Define the interface to which the position encoder is connected.
6. I00 Position range:  
Define whether the travel range of the axis is limited or endless (modulo).
7. If you have selected 1: Endless for I00, parameterize a revolution length (see [Scale the axis](#) [▶ 249]).

#### Information

When you parameterize I05 Type of axis, you can either use the selection 0: User defined, rotational or 1: User defined, translational to configure units of measure and the number of decimal places for the axis model individually or use the selections 2: Rotational and 3: Translational to revert to preset values.

Selection 0: User defined, rotational and selection 1: User defined, translational let you configure the unit of measure (I09) and the decimal places (I06) individually. Velocity, acceleration and jerk are represented as the derivative of the unit of measure with respect to time.

Selection 2: Rotational sets the following units of measure for the axis model: position in °, velocity in rpm, acceleration in  $\text{rad/s}^2$ , jerk in  $\text{rad/s}^3$ .

Selection 3: Translational sets the following units of measure for the axis model: position in mm, velocity in m/s, acceleration in  $\text{m/s}^2$ , jerk in  $\text{m/s}^3$ .

#### Information

If you do not parameterize it differently for I02 Position encoder, B26 Motor encoder is used for position control as standard.



### 14.2.2.2 Scale the axis

1. Select the relevant drive controller in the project tree and click on the first projected axis in the Project menu > Wizard area.
2. Select the Axis model wizard > Axis: Scaling.
3. Scale the axis by configuring the overall gear ratio between the motor and output.  
To simplify this scaling for you, you are provided with the scaling calculator Conversion of positions, velocities, accelerations, torque/force, which calculates the effects of changed motion variables on the entire system.
4. I01 Circular length:  
If you have selected 1: Endless for I00 Position range, enter the revolution length.
5. I06 Decimal places position (optional):  
If you have selected 0: User defined, rotational or 1: User defined, translational for I05 Type of axis, define the desired number of decimal places.
6. I09 Measure unit (optional):  
If you have selected 0: User defined, rotational or 1: User defined, translational for I05 Type of axis, define the desired unit of measure.

#### Information

A change to parameter I06 moves the decimal separator for all axis-specific values!  
Ideally, change I06 before parameterizing other axis-specific values and then check them afterwards.

#### Information

Parameter I297 Maximum speed position encoder must be parameterized according to your application case. If I297 is set too low, the permitted maximum speed is exceeded even at normal operating speeds. On the other hand, if I297 is set too high, measuring errors of the encoder can be overlooked.

I297 depends on the following parameters: I05 Type of axis, I06 Decimal places position, I09 Measure unit as well as I07 Distance factor numerator position and I08 Distance factor denominator position for applications of type Drive Based or PROFIdrive or A585 Feed constant for applications of type CiA 402. If you have made changes to one of the parameters listed, select I297 accordingly as well.

### 14.2.2.3 Parameterize the position and velocity window

Enter position limits and velocity zones for set values. To do so, parameterize boundary values for reaching a position or velocity.

1. Select the Axis model wizard > Window position, velocity.
2. C40 Velocity window:  
Parameterize a tolerance range for velocity tests.
3. I22 Target window:  
Parameterize a tolerance range for position tests.
4. I87 Actual position in window time:  
Parameterize how long a drive must stay in the specified position range before a corresponding status message is output.
5. Parameterize a tolerance range for lag tests.

#### 14.2.2.4 Limiting the axis

If necessary, limit the movement variables for position, velocity, acceleration, jerk as well as torque/force according to the applicable conditions for your axis model.

##### Limiting the position (optional)

1. Select the relevant drive controller in the project tree and click on the first projected axis in the Project menu > Wizard area.
2. Select the Axis model wizard > Limit: Position.
3. If necessary, limit the position of your axis using a software or hardware limit switch to secure the travel range.

##### Limiting velocity, acceleration, jerk (optional)

The default values are designed for slow velocities without gear units. For this reason, adapt the saved values.

For example, verify the maximum velocity of the motor (B83) against the velocity of the output (I10).

1. Select the Motor wizard.
2. Determine the maximum possible motor velocity in parameter B83 v-max motor.
3. Select the Axis model wizard > Axis: Scaling > Conversion of positions, velocities, accelerations, torque/force area.
4. Velocity line:  
Enter the maximum motor velocity from B83 in the Velocity line of the Motor column and confirm with ENTER.  
⇒ The maximum velocity of the motor has been transferred to the output.
5. Repeat the procedure for other limits, such as for the gear unit input speed (C11).
6. Select the Axis model wizard > Limit: Velocity, acceleration, jerk.
7. I10 Maximal speed:  
Limit the maximum velocity of the output, taking into account the determined system limits and the maximum motor velocity B83.
8. Determine the limiting values for acceleration and jerk if necessary and enter them into the associated parameters.

##### Limiting torque/force (optional)

The default values take into account the rated operation together with the overload reserves.

1. Select the Axis model wizard > Limit: Torque/force.
2. If the motor force must be limited, adapt the saved values as necessary.

## 14.3 Transmitting and saving a configuration

In order to transmit and save the configuration to one or more drive controllers, you must connect your PC and the drive controllers over the network.

### **WARNING!**

#### **Injury to persons and material damage due to axis movement!**

If there is an online connection between DriveControlSuite and the drive controller, changes to the configuration can lead to unexpected axis movements.

- Only change the configuration if you have visual contact with the axis.
- Make sure that no people or objects are within the travel range.
- For access via remote maintenance, there must be a communication link between you and a person on site with eye contact to the axis.

### **Information**

During the search, all drive controllers within the broadcast domain are found via IPv4 limited broadcast.

Requirements for finding a drive controller in the network:

- Network supports IPv4 limited broadcast
- All drive controllers and the PC are in the same subnet (broadcast domain)

### 14.3.1 Transmitting the configuration

The steps for transmitting the configuration vary depending on the safety technology.

#### **Drive controller without SE6 option**

- ✓ You have verified the plausibility of the predefined test motion variables.
  - ✓ The drive controllers are switched on.
1. In the project tree, select the module under which you have recorded your drive controller and click **Online connection** in the project menu.
    - ⇒ The **Add connection** dialog box opens. All drive controllers found via IPv4 limited broadcast are displayed.
  2. **Direct connection tab > IP address column:**  
 Activate the IP addresses in question and confirm your selection with **OK**.
    - ⇒ The **Online functions** window opens. All drive controllers connected through the previously selected IP addresses are displayed.
  3. Select the drive controller to which you want to transmit a configuration and change the selection of the transmission type from **Read** to **Send**.
  4. Change the selection **Create new drive controller:**  
 Select the configuration that you would like to transfer to the drive controller.
  5. Repeat steps 3 and 4 for all other drive controllers to which you would like to transfer your configuration.
  6. **Online tab:**  
 Click **Establish online connection**.
    - ⇒ The configurations are transferred to the drive controllers.

### Drive controller with SE6 option

- ✓ You have verified the plausibility of the predefined test motion variables.
  - ✓ The drive controllers are switched on.
1. In the project tree, select the module under which you have recorded your drive controller and click **Online connection** in the project menu.
    - ⇒ The **Add connection** dialog box opens. All drive controllers found via IPv4 limited broadcast are displayed.
  2. **Direct connection tab > IP address column:**  
 Activate the IP addresses in question and confirm your selection with **OK**.
    - ⇒ The **Online functions** window opens. All drive controllers connected through the previously selected IP addresses are displayed.
  3. Select the drive controller to which you want to transmit a configuration and change the selection of the transmission type from **Read** to **Send**.
  4. Change the selection **Create new drive controller:**  
 Select the configuration that you would like to transfer to the drive controller.
  5. Repeat steps 3 and 4 for all other drive controllers to which you would like to transfer your configuration.
  6. **Online tab:**  
 Click **Establish online connection**.
    - ⇒ The configurations are transferred to the drive controllers.
    - ⇒ A dialog box prompts you to open the **PASmotion** configuration tool.
1. Confirm the dialog box with **Yes**.
    - ⇒ **PASmotion** opens.
  2. In the **PASmotion** project administration, navigate to the safety module for the drive controller and double-click to open it.
    - ⇒ The dialog box for the password prompt opens.
  3. Enter the password and confirm with **OK**.
    - ⇒ The wizard for device synchronization opens.
    - ⇒ Device configuration and configuration are checked against each other automatically.
  4. **Optional:** If the configurations match, click on **Done** after device synchronization has finished.
  5. **Optional:** If the configurations do not match, click on **Next** after device synchronization has finished.
    - 5.1. Confirm the production number of the safety module and click **Next**.
    - 5.2. Enter the password for the configuration on the safety module and click **Next**.
    - 5.3. Click **Upload** to transfer the device configuration to the project.
    - 5.4. After the successful transfer, click **Done**.
  6. Exit **PASmotion**.
    - ⇒ The safety configuration is transferred to the selected drive controller.

## 14.3.2 Saving the configuration

- ✓ You have successfully transmitted the configuration.
- 1. Online functions window:  
Click Save values (A00).  
⇒ The Save values (A00) window opens.
- 2. Click Start action.  
⇒ The configuration is stored on the drive controllers in non-volatile memory.
- 3. Close the Save values (A00) window.

### Information

For the configuration to take effect on the drive controller, a restart is required when the configuration is saved on the drive controller for the first time or when changes are made to the firmware or process data mapping.

### Restarting a drive controller

- ✓ You have stored the configuration on the drive controller in non-volatile memory.
- 1. Online functions window:  
Click Restart (A09).  
⇒ The Restart (A09) window opens.
- 2. Select which of the connected drive controllers you want to restart.
- 3. Click Start action.
- 4. Confirm the safety instruction with OK.  
⇒ The Restart (A09) window closes.
- ⇒ The fieldbus communication and connection between DriveControlSuite and drive controllers are interrupted.
- ⇒ The selected drive controllers restart.

## 14.4 Testing the configuration

Before you continue with the parameterization, we recommend testing your projected axis model using the jog control panel.

Check your projected axis model as well as your configured electrical and mechanical data for plausibility by transferring your configuration to one of your drive controllers for test purposes and controlling the drive using the jog control panel instead of using a controller.

### Information

Check the suitability of the default values for your application before starting the test. If they appear too large or unsuitable compared with the results of the scaling calculator, replace them with values that are more suitable for test operation.

You can quickly and easily test the project configuration using the DriveControlSuite software or directly using the drive controller display.

## 14.4.1 Testing using DriveControlSuite

### WARNING!

#### Injury to persons and material damage due to axis movement!

When you activate the control panel, DriveControlSuite gives you sole control of the motions of the axis. If you are using a controller, it no longer monitors the axis movements after the control panel is activated. The controller cannot intervene to prevent collisions. The controller takes over control again when the control panel is deactivated, which can cause unexpected axis movements.

- Do not switch to other windows when the control panel is active.
- Only use the control panel if you have visual contact with the axis.
- Make sure that no people or objects are within the travel range.
- For access via remote maintenance, there must be a communication link between you and a person on site with eye contact to the axis.

- ✓ You have successfully saved the configuration.
  - ✓ There must not be any active safety function.
  - ✓ The drive controller is switched on and connected to the network.
  - ✓ There is an online connection between DriveControlSuite and the drive controller.
1. Select the relevant drive controller in the project tree and click on the first projected axis in the Project menu > Wizard area.
  2. Select the Jog control panel wizard.
  3. Click Control panel on and then Enable.
    - ⇒ The drive is controlled using the activated control panel.
  4. Move the axis step-by-step and test the direction of motion, velocity, distances, etc. using the Jog+, Jog-, Jog step+ and Jog step- buttons.
  5. Optimize your project configuration based on your test results as necessary.
  6. To deactivate the control panel, click on Control panel off.

### Information

Jog+ and Jog- cause a continual manual movement in the positive or negative direction. Jog step+ and Jog step- move the axis relative to the current actual position by the increment specified in I14.

Jog+ and Jog- have a higher priority than Jog step+ and Jog step-.

## 14.4.2 Testing using the operating unit

You have connected the SD6 drive controller along with its accessories as described and would like to test the components in the group for correct wiring and functionality. STOBER standard parameterization enables an initial function test if you are operating the drive controller together with a STOBER synchronous servo motor and an EnDat encoder. In this case, the electronic nameplate of the motor is read out when the device starts and the accompanying data is transferred into the drive controller.

### 14.4.2.1 Schematic test sequence

#### Schematic test sequence

The following illustration shows the schematic sequence of the wiring and function test.

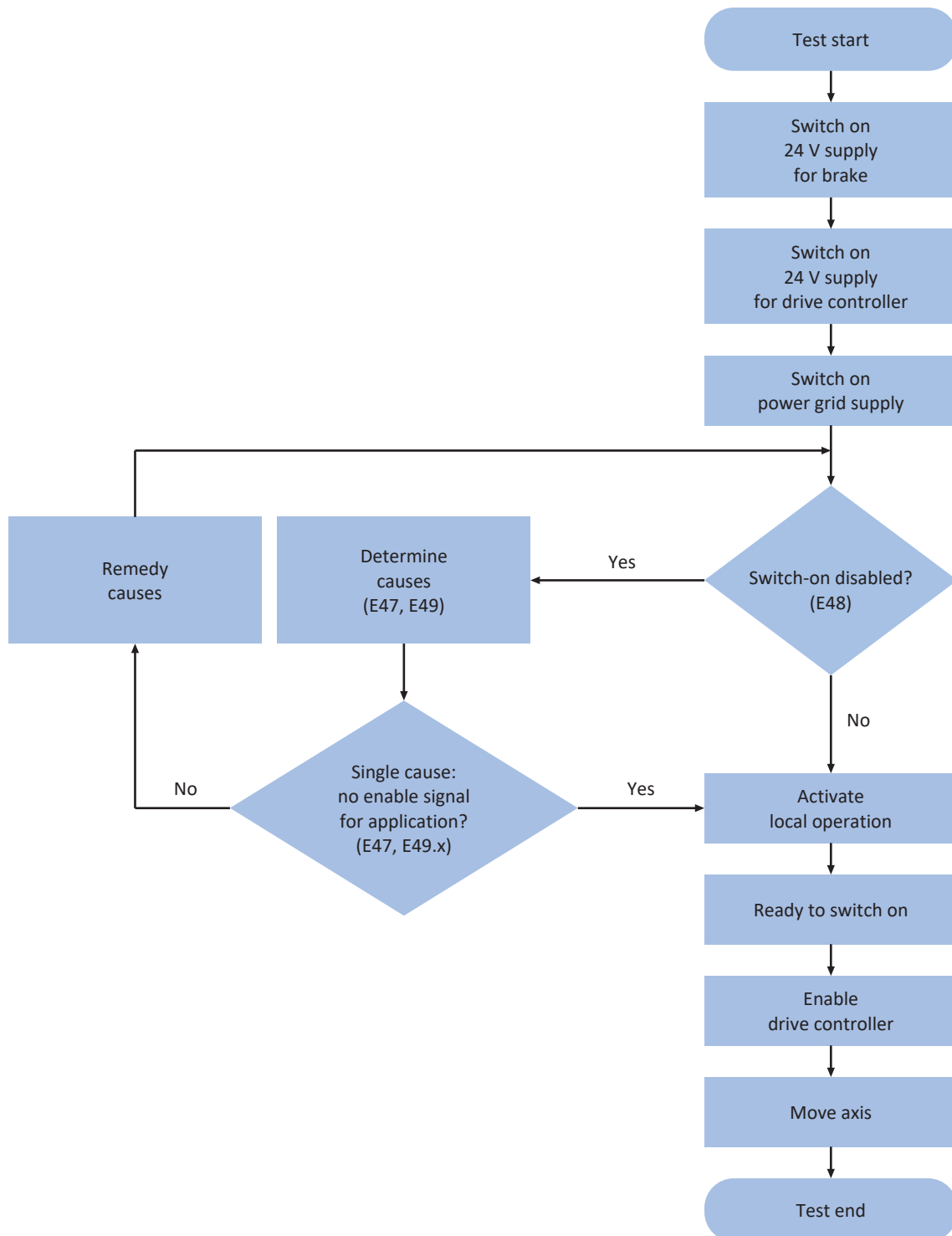

Fig. 58: Schematic test sequence for wiring and function test

### 14.4.2.2 Practical test sequence

#### DANGER!

#### Danger to life from moving parts!

Motor shaft rotates during the wiring and function test described below!

- Clear the danger area before the test.
- Do not connect any downstream mechanical parts to the motor or gear unit until the test has finished.
- Make sure that components attached to the motor, such as feather keys or coupling elements, are sufficiently secured against centrifugal forces.

Perform the individual steps in the specified order.

#### Preparing for the test

1. Switch on the 24 V<sub>DC</sub> supply of the brake.
  2. Switch on the 24 V<sub>DC</sub> supply of the drive controller.
  3. Switch on the power grid supply.
  4. Optional: If you are using the ST6 safety module, deactivate the STO safety function, such as by connecting 24 V<sub>DC</sub> to terminal X12.
  5. Optional: If you use the SE6 safety module, deactivate the STO safety function by connecting terminals X14 and X15 according to your safety configuration.
- ⇒ The drive controller either switches to the "ready to switch on" or "locked" state.

#### Performing the test

✓ Drive controller is ready to switch on:

1. Activate local operation using the [Manual] button.
  2. Enable the drive controller using the [I/O] button.
  3. Rotate the motor axis using the left and right arrow buttons at the velocity and acceleration configured in parameter I12.
- ⇒ You have correctly wired all components; the function test completed successfully.

✓ Drive controller is locked (display = 1: Switch-on disable, parameter E48):

1. Determine the causes for the switch-on lockout and remedy them:  
Parameter E49 outputs possible causes in code and parameter E47 shows them in plain text.
2. Then, carry out the test (see the section "Drive controller is ready to switch on").

#### Information

If the lack of enable signal for the CiA 402 application is the sole cause for the switch-on lockout, switch to local operation directly and carry out the test (see the section "Drive controller is ready to switch on").

#### Finishing the test

1. Lock the drive controller using the [I/O] button.
2. Switch to normal operation using the [Manual] button.



## 15 Communication

The following options are available for communicating with the SD6 drive controller:

- Communication between drive controller and controller
  - Fieldbus
  - Terminals
- Communication between drive controllers for synchronous operation
  - IGB motion bus
- Communication between drive controller and PC for commissioning, optimization and diagnostics
  - Direct connection
  - Fieldbus
  - Remote maintenance

The DriveControlSuite project configuration and commissioning software installed on the PC is able to handle multiple direct connections and remote maintenance sessions simultaneously.

### Information

Note that an IGB network can never be addressed via remote maintenance and direct connection at the same time.

## 15.1 Direct connection

A direct connection is a network connection in which all nodes are in the same network.

In its simplest form, a direct connection is a point-to-point cable connection between the network interface of the PC where DriveControlSuite is installed and the network interface of the drive controller. Switches or routers can also be used in place of a simple network cable.

The IP address required for direct connection is either assigned automatically by DriveControlSuite or using DHCP, or it is specified manually.

### Requirements

Type of direct connection	Requirements
Automatic	The A166 parameter in DriveControlSuite must be set to 2: DHCP + DS6 for the direct connection to be established automatically. In addition, the network adapter used on the PC side should be set to "Obtain IP address automatically".
Manual	If the IP address of the drive controller was specified manually, the socket of the gateway device and the network connection of the PC must have IP addresses from the same subnet.

Tab. 282: Requirements for a direct connection

In addition, obey the requirements (see [Communication requirements \[▶ 442\]](#)).

### Virtual machines

If you want to connect STOBER drive controllers to DriveControlSuite from a virtual machine, pay attention to the configuration information (see [Configuring virtual machines \[▶ 444\]](#)).

## 15.2 Remote maintenance

By remote maintenance, we are referring to indirectly connecting a PC to a drive controller over a local network, intranet or the Internet for the purpose of maintenance or support. Remote maintenance allows you to run all of the functions that are possible over a direct connection. It is also possible to transfer and run files or firmware updates. You can follow along on the screen with all of the actions taken by our service employee.

STOBER provides a separate teleserver for remote maintenance.

### STOBER remote maintenance

STOBER remote maintenance is an indirect communication connection between the drive controller and PC using a teleserver operated by STOBER and secured over the Internet.

## 15.3 IGB motion bus

For more detailed information on communication over IGB motion bus, refer to the Drive Based Synchronous application manual (see [Detailed information \[▶ 476\]](#)).

## 15.4 Fieldbus

For detailed information about the fieldbus connection, refer to the corresponding manual (see [Detailed information \[▶ 476\]](#)).

## 16 Optimizing the control cascade

The following chapters describe the structure of the control cascade first as a basis, as well as the general procedure for optimizing it. Then, you learn how you can check your control cascade based on a few parameters for nearly 80% of all applications and, if necessary, optimize the pre-set values for your specific application case. Special cases are addressed at the end of the chapter.

### 16.1 Structure of the control cascade

The control cascade triggers the appropriate electrical actuation of the motor for a requested movement. The structure of the control cascade depends on the control mode set in B20.

The following graphic shows the control cascade using a motor with encoder in vector-controlled operation as an example. The representation of the control cascade follows the signal course: Position controller > Velocity controller > Current controller.

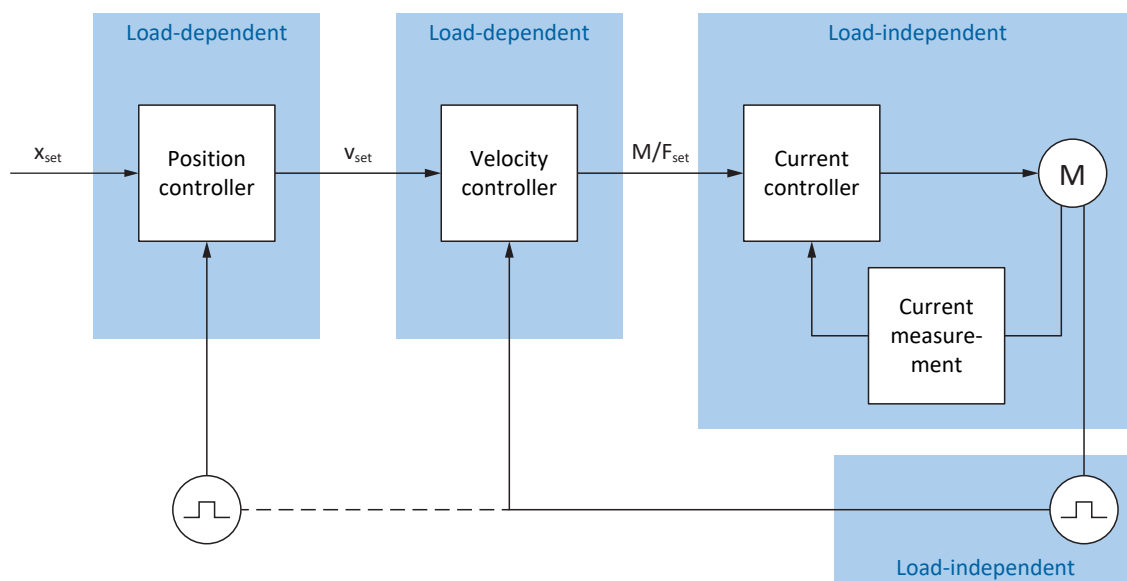

Fig. 59: Structure of the control cascade

#### Position controller

The position controller is a P controller (proportional controller) with feedforward control. The settings for the position controller are load-dependent.

The following applications use position control:

- Drive Based applications for the following commands:
  - MC\_MoveAbsolute
  - MC\_MoveRelative
  - MC\_MoveAdditive
  - MC\_MoveVelocity
- CiA 402 application in the following operating modes:
  - Cyclic synchronous position mode
  - Profile position mode
- Application-independent with position control in jog mode

### Velocity controller

The velocity controller is a PI controller (proportional-integral controller). The settings for the velocity controller are load-dependent. Velocity control is always required for vector control.

### Current controller

The current controller is a PID controller (proportional-integral-differential controller). The settings for the current controller are load-independent. The current controller is always required for vector control.

## 16.2 General procedure

Before making changes to your control cascade, observe the following information on the general procedure for optimization.

### Defining the optimization goal

First, define the goal that you want to reach through optimization:

- High dynamics
- High energy efficiency
- Positioning accuracy
- Smooth operation
- Minimal control deviation
- High velocity

Some goals can only be combined under certain conditions or are mutually exclusive.

### Hardware components as possible limits of optimization

An optimal drive train always consists of a coordinated system of all hardware components (gear unit, motor, encoder, drive controller and cable). Consequently, optimization depends not only on your parameter settings, but also on the hardware components used.

### Drive controller presets

If you use components from STOBER, all data is transmitted to the corresponding parameters when reading out the electronic nameplate or upon selection of the motor from the motor database – eliminating the need for complex parameterization of the motor, encoder and brake. These default values are carefully selected and checked, and generally deliver good results. Only change the default values when necessary, taking the following points into consideration:

1. First, record the current behavior of your drive train with a scope image.
2. Carry out the optimization of your control cascade in the opposite order of the signal course: Current controller > velocity controller > position controller, i.e. from the motor back to the set value specification. However, do not make adjustments to the current controller if you are using components from STOBER.
3. If adjustments are necessary, only ever change one setting and then check every change with a scope image.

## 16.3 Example project

The optimization described in the following chapters is based on the following general conditions and settings.

### Specified goal

High dynamics with the highest possible velocity, but without the system overshooting.

### System components

- 6th generation STOBER drive controller
- STOBER synchronous servo motor with absolute encoder and electronic nameplate
- DriveControlSuite commissioning software
- Load supplied to the motor

### Application and device control

- Drive Based application
- Drive Based device control

### 16.3.1 Scope settings

For the scope image at the beginning and after each adjustment, we recommend the settings described below to be able to compare the different results with each other.

#### General settings

- Sampling time: 250  $\mu$ s
- Pre-trigger: 5%

#### Channels

Using the [Parameter selection](#) and the associated picklists, define the relevant parameters for the scope image.

#### Trigger condition

- Simple trigger
- Source: Parameter E15 v-motor-encoder
- Absolute value: Yes
- Condition: Greater
- Edge: Yes
- Comparison value: 5.0 rpm

## 16.3.2 Jog settings

During optimization, test each change using the Jog control panel with the following settings:

- I26 Jog control mode:
  - Optimization of the velocity controller: Select 0: Velocity control to receive pure velocity control without a higher-level position controller with the Jog+ and Jog– bit.
  - Optimization of the position controller: Select 1: Position control with the Jog step+ und Jog step– bit.
- I14 Jog step:  
Define the increment.
- I12 Jog velocity:  
Define the jog velocity.
- I13 Jog acceleration:  
For the jog acceleration, select a value that is higher than the velocity by a factor of 10.
- I45 Jog deceleration:  
For the jog deceleration, select a value that is higher than the velocity by a factor of 10.
- I18 Jog jerk:  
For the jog jerk, select a value that is higher than the acceleration by a factor of 10.

## 16.4 Schematic sequence

The following graphic shows the schematic sequence for optimizing the control cascade. The specific steps that are required depend on the control mode. The information on optimization assumes the following control modes:

- B20 = 64: SSM - vector control for synchronous servo motors
- B20 = 2: ASM - vector control for asynchronous motors

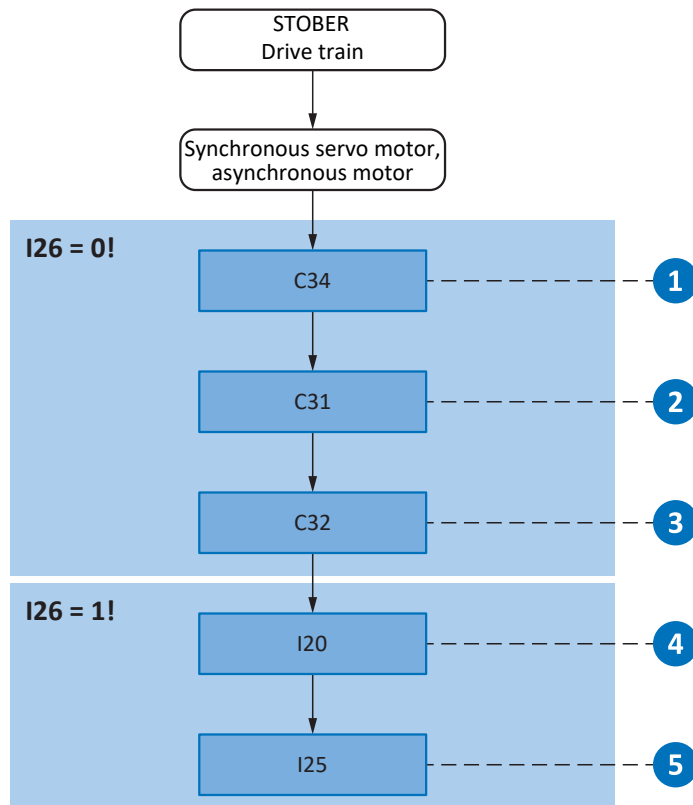

Fig. 60: Schematic sequence of optimization based on relevant parameters

- 1 Velocity controller – Defining filters for the actual velocity
- 2 Velocity controller – Defining the proportional coefficient
- 3 Velocity controller – Defining the integral coefficient
- 4 Position controller – Defining the proportional coefficient
- 5 Position controller – Defining the feedforward control of the velocity controller

## 16.5 Current controller – Notes

The current controller settings depend exclusively on the motor type, not on the load or application.

Do not make any changes to the current controller if you are using components from STOBER!

The data of a STOBER motor is part of the DriveControlSuite motor database as well as the electronic nameplate. This data is transferred to the respective parameters during project configuration or when reading out the nameplate. All additional data on the brake and encoder is transferred at the same time. These settings were calibrated in the STOBER test bay and no longer need to be adjusted.

## 16.6 1: Velocity controller – Actual velocity filters

The following graphic shows the influence of the lowpass filter time constant on the velocity controller.

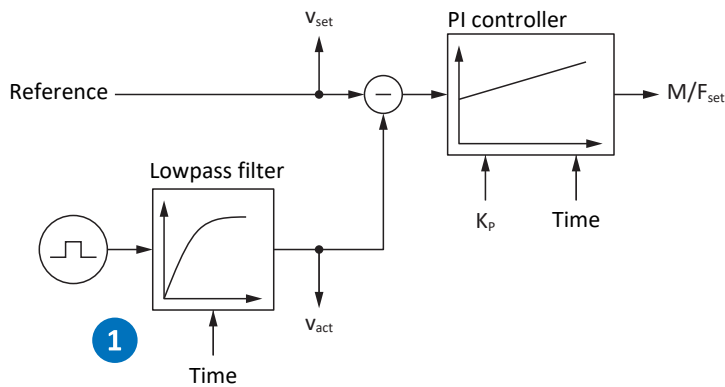

Fig. 61: Velocity controller – Filters for the actual velocity

The lowpass filter time constant for the actual velocity of the motor encoder is defined in C34.

### Effects

C34 affects the smooth operation of the motor and the dynamics that can be achieved with the drive; as C34 increases, smooth operation rises and the dynamics drop.

Furthermore, C34 also has a direct influence on the maximum possible coefficient, since a large filter time also requires a large downtime.

### Procedure

Select a value for C34 that is large enough to minimize the measurement and quantization noise, but is as small as possible to avoid unnecessary downtime, since this makes the system unstable and reduces dynamics.

Guide values for C34 when using a STOBER motor can be found in the following table.

Encoder model	Encoder interface	Guide value C34 [ms]
EBI 135	EnDat 2.2 digital	0.4 – 0.6
EBI 1135	EnDat 2.2 digital	0.4 – 0.6
ECI 119	EnDat 2.2 digital	0.4 – 0.6
ECI 1118-G1	EnDat 2.1 digital	1.4 – 1.8
ECI 1118-G2	EnDat 2.2 digital	0.4 – 0.6
ECI 1119	EnDat 2.2 digital	0.4 – 0.6
ECI 1319	EnDat 2.1 digital	1.2 – 1.8
ECN 1113	EnDat 2.1 digital	0.8 – 1.2
ECN 1123	EnDat 2.2 digital	0.2 – 0.4
ECN 1313	EnDat 2.1 digital	0.8 – 1.2
ECN 1313	EnDat 2.1 sin/cos	0.2 – 0.8
ECN 1325	EnDat 2.2 digital	0.0 – 0.2
EDM 35	HIPERFACE DSL	0.4 – 0.6
EDS 35	HIPERFACE DSL	0.4 – 0.6
EKM 36	HIPERFACE DSL	0.4 – 0.6



Encoder model	Encoder interface	Guide value C34 [ms]
EKS 36	HIPERFACE DSL	0.4 – 0.6
EQI 1130	EnDat 2.1 digital	1.4 – 1.8
EQI 1131	EnDat 2.2 digital, EnDat 3	0.4 – 0.6
EQI 1329	EnDat 2.1 digital	1.2 – 1.8
EQI 1331	EnDat 2.1 digital	1.2 – 1.8
EQN 425	EnDat 2.1	0.8 – 1.2
EQN 425	SSI	0.8 – 1.2
EQN 1125	EnDat 2.1 digital	0.8 – 1.2
EQN 1125	EnDat 2.1 sin/cos	0.4 – 0.8
EQN 1135	EnDat 2.2 digital	0.2 – 0.4
EQN 1325	EnDat 2.1 digital	0.8 – 1.2
EQN 1325	EnDat 2.1 sin/cos	0.2 – 0.8
EQN 1337	EnDat 2.2 digital	0.0 – 0.2
Incremental; 1024 increments/revolution	HTL/TTL	2.0
Incremental; 2048 increments/revolution	HTL/TTL	1.4
Incremental; 4096 increments/revolution	HTL/TTL	0.8
Resolver; 2 poles	Analog	1.4 – 2.0
Resolver; 4 poles	Analog	1.2 – 1.8
Resolver; 6 poles	Analog	1.0 – 1.6
Resolver; 8 poles	Analog	0.8 – 1.4

Tab. 283: Guide values for C34

### Scope image

Requirements:

- I26 = 0: Velocity control
- C34 = Guide value or value taken from firmware

Parameter for the scope image:

- E06 V-reference motor
- E15 v-motor-encoder

## 16.7 2: Velocity controller – Proportional coefficient

The following graphic shows the influence of the proportional coefficient on the velocity controller.

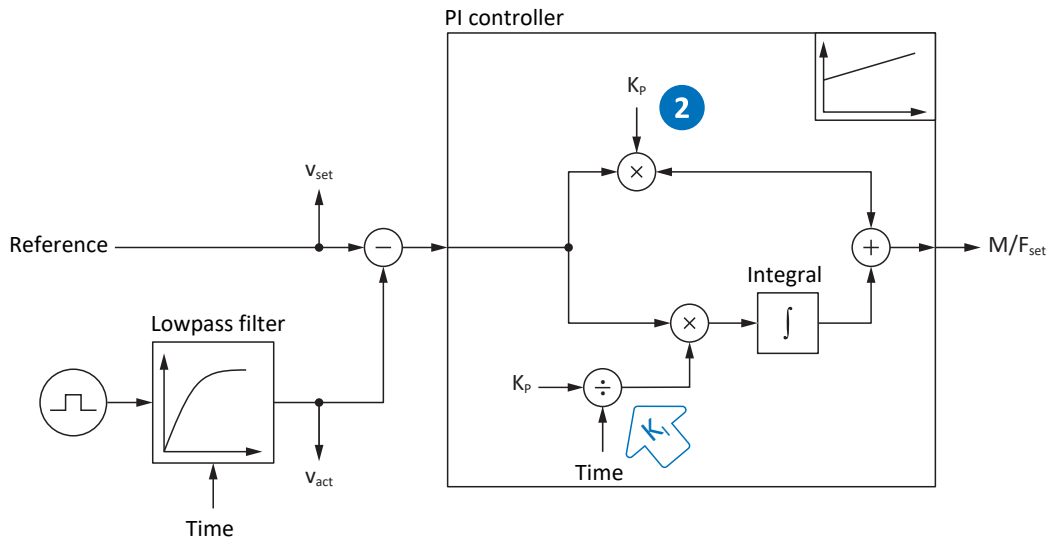

Fig. 62: Velocity controller – Proportional coefficient

The proportional coefficient  $K_p$  of the velocity controller can be defined in C31.

### Effects

An adjustment of the P-share always has an effect on the I-share as well. The reason for this is the following dependency:

The integral coefficient  $K_i$  of the velocity controller results from the proportional coefficient  $K_p$  and reset time  $T_i$  ( $K_i = K_p \div T_i = C31 \times C35 \div C32$ ).

### Procedure

1. Start with the default value for C31.
2. First, enter the value 0 ms for the reset time in C32 to deactivate the I-share initially.
3. Increase the value of C31 up to the stability limit.
4. Define the value of C31 approximately 10% below the stability limit.

### Scope image

Requirements:

- I26 = 0: Velocity control
- C34 = Guide value or value taken from firmware
- C32 = 0 ms
- C31 = e.g. 10, 20, 50, 150 and 200%

Parameter for the scope image:

- E06 V-reference motor
- E15 v-motor-encoder

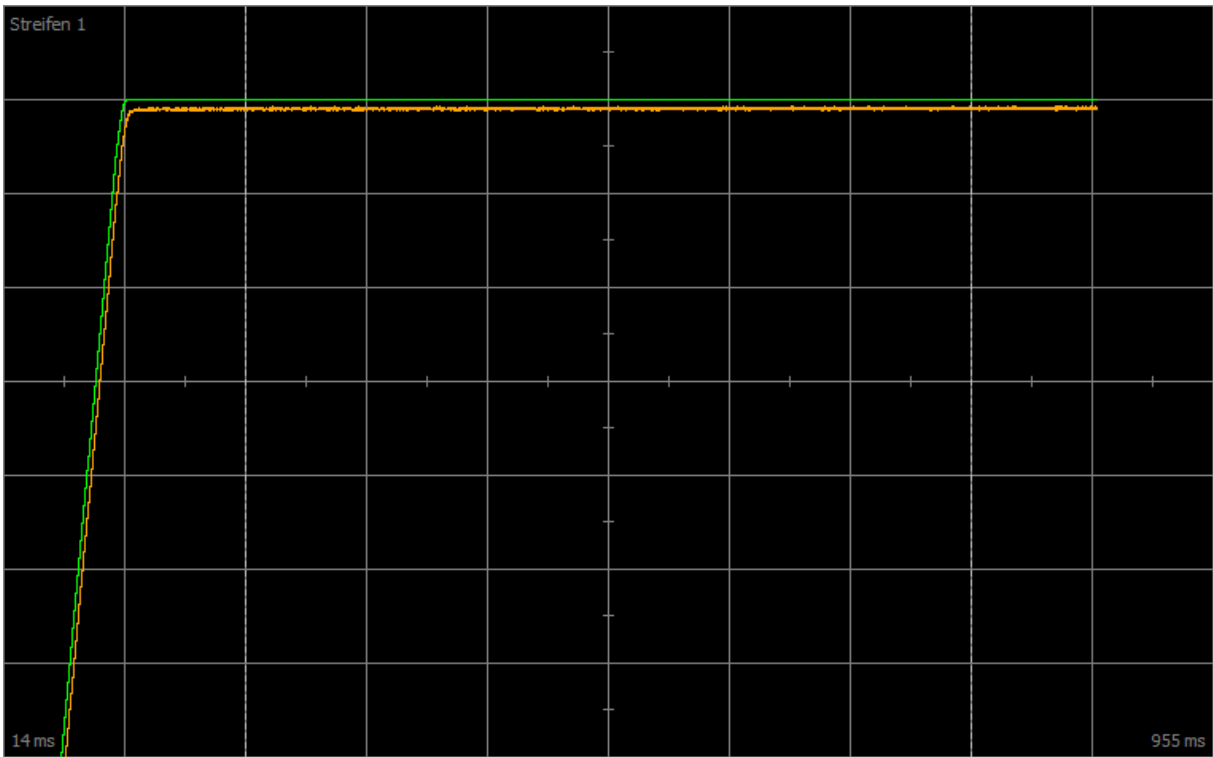

Fig. 63: Scope – Proportional coefficient of the velocity controller (C31), default value

Green      Set value  
Brown     Actual value with default value

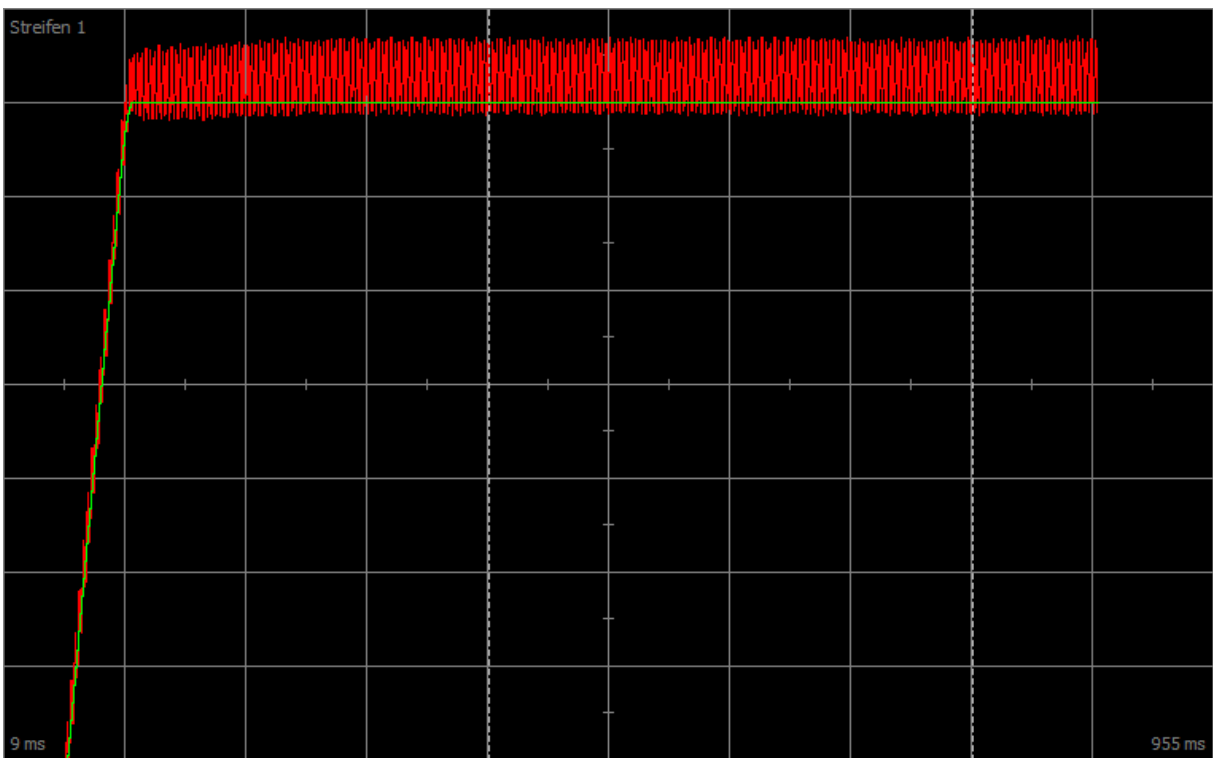

Fig. 64: Scope – Proportional coefficient of the velocity controller (C31), continuous oscillations

Green      Set value  
Red        Actual value that exhibits continuous oscillation upon reaching the stability limit

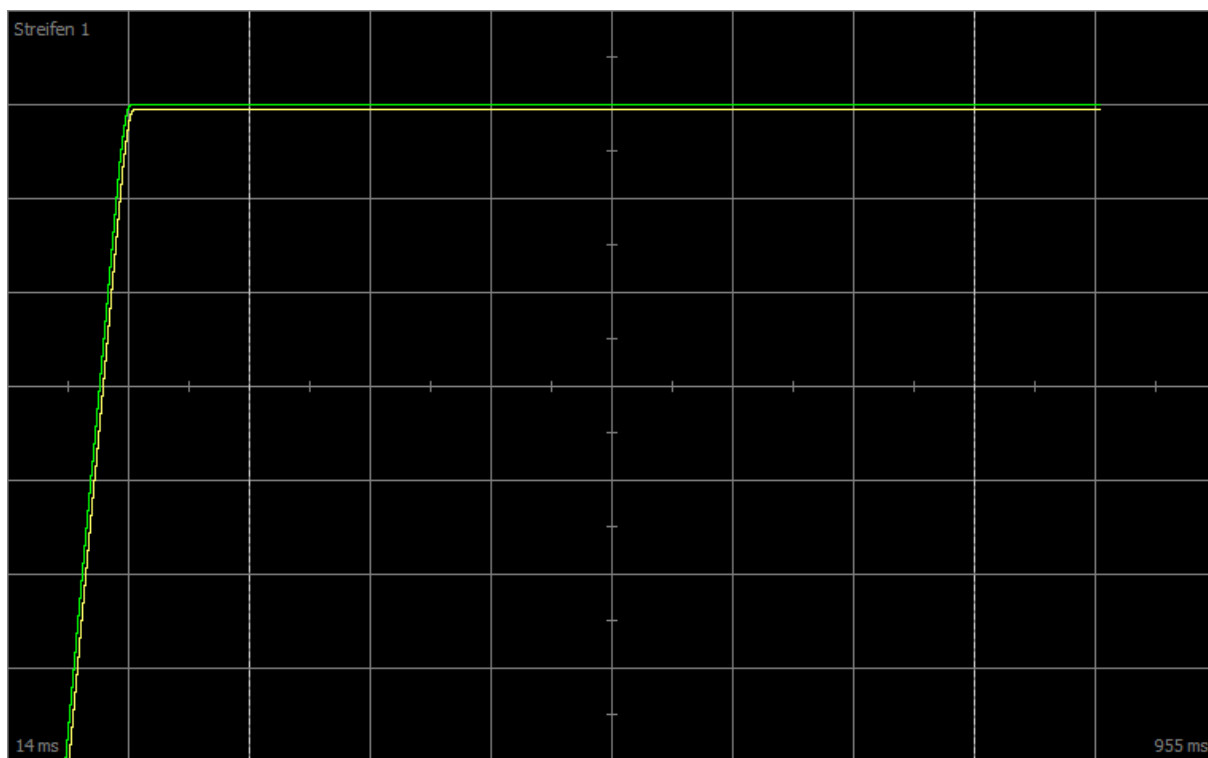

Fig. 65: Scope – Proportional coefficient of the velocity controller (C31), optimized value

Green      Set value  
Yellow     Actual value with optimized coefficient

The zoom factor was increased for the following scope image to show overshooting based on additional values, which devolves into continuous oscillations upon reaching the stability limit.

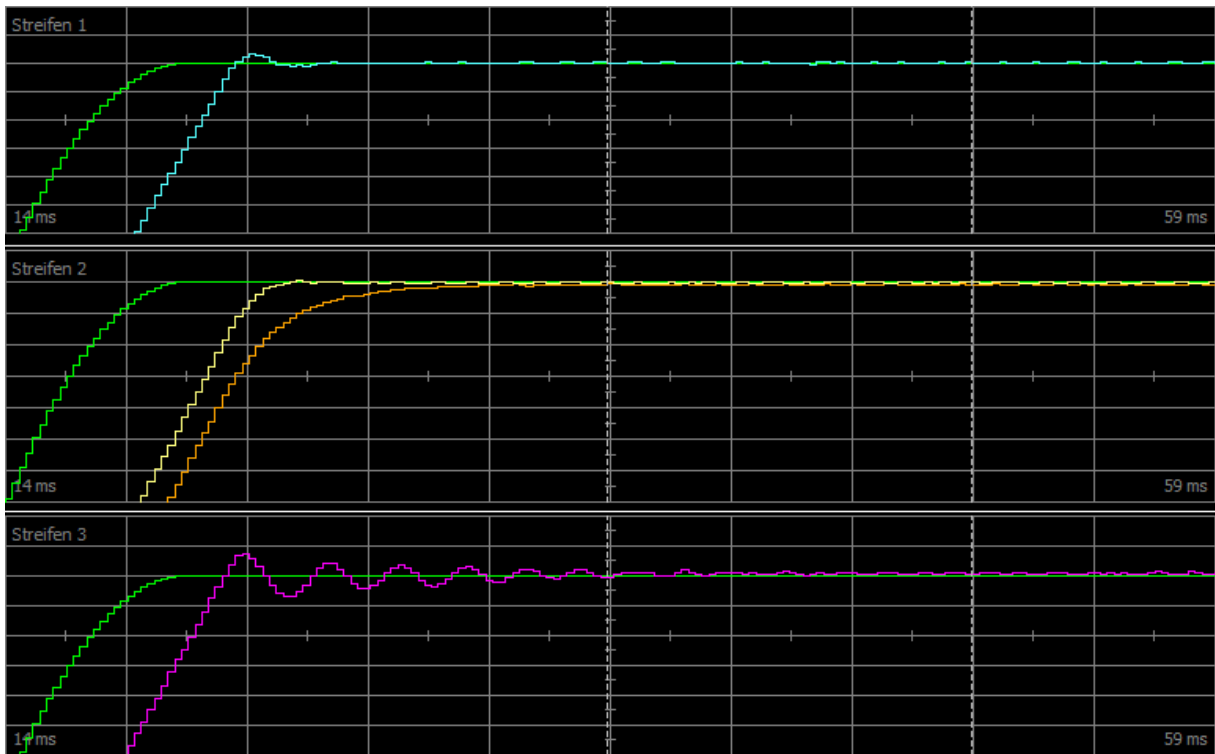

Fig. 66: Scope – Proportional coefficient of the velocity controller (C31), overshooting

- Green      Set value
- Turquoise    Actual value that shows brief overshooting
- Yellow      Actual value with optimized coefficient
- Brown      Actual value with default value
- Pink        Actual value that shows long overshooting with phase-out

## 16.8 3: Velocity controller – Integral coefficient

The following graphic shows the influence of the integral coefficient on the velocity controller.

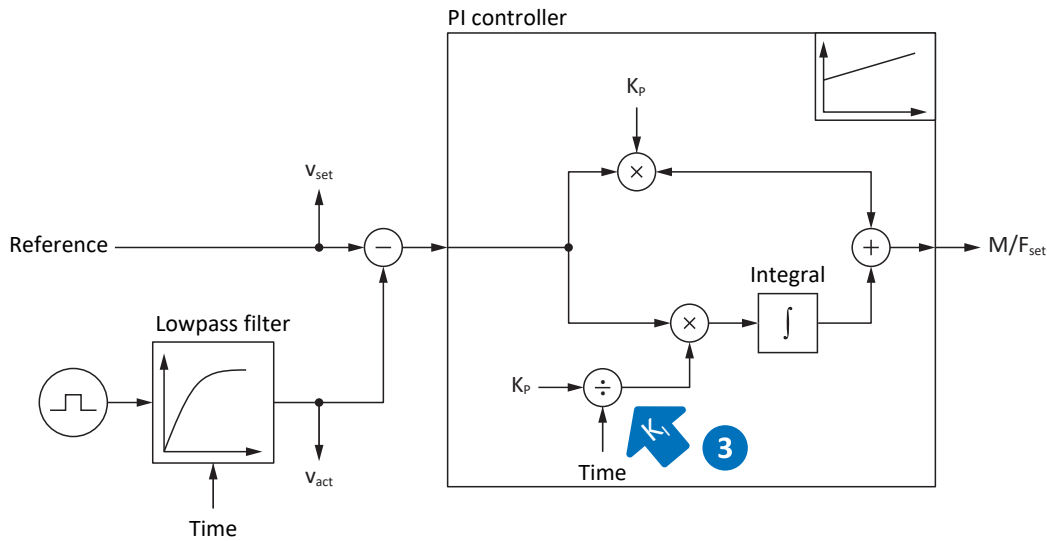

Fig. 67: Velocity controller – Integral coefficient

The integral coefficient  $K_i$  of the velocity controller results from the proportional coefficient  $K_p$  and reset time  $T_i$  ( $K_i = K_p \div T_i = C31 \times C35 \div C32$ ).

### Effects

Since the value of C31 was already optimized in the previous step, the integral coefficient is optimized in this step by adjusting the reset time in C32.

### Procedure

1. Start with the default value for C32.
2. Reduce the value of C32 in order to recover more quickly. In this process, note that if  $C32 \leq 1$  ms, the I-share is deactivated.
3. Increase the value of C32 up to the stability limit.
4. Define the value of C32 approximately 10% above the stability limit.

### Scope image

Requirements:

- I26 = 0: Velocity control
- C34 = Guide value or value taken from firmware
- C31 = Already optimized value
- C32 = e.g. 0, 5, 10 and 50 ms

Parameter for the scope image:

- E06 V-reference motor
- E15 v-motor-encoder

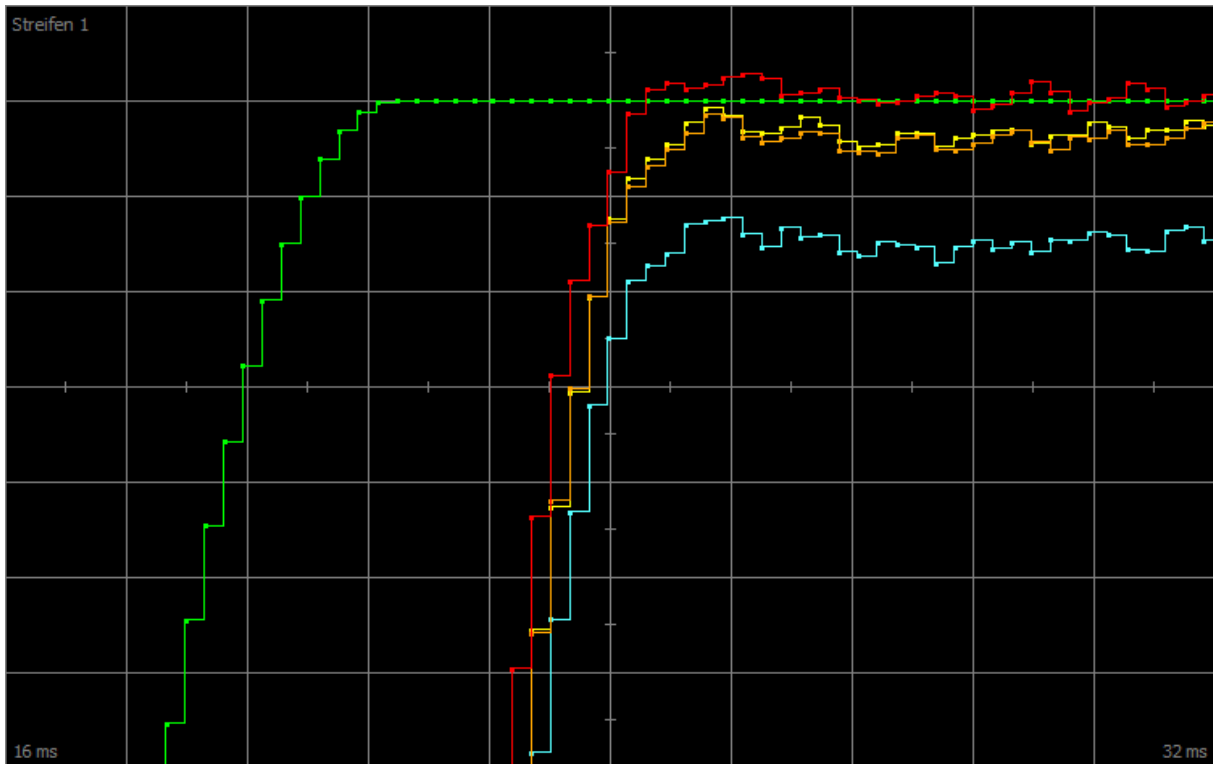

Fig. 68: Scope – Integral coefficient of the velocity controller (C32)

Green	Set value
Red	Actual value that exhibits overshooting
Yellow	Actual value with optimized coefficient
Brown	Actual value with default value
Turquoise	Actual value with deactivated coefficient ( $\leq 1$ )

## 16.9 Velocity controller – Summary

In summary, the following conclusions can be drawn for the optimization of the velocity controller:

- Simple encoders must be filtered more heavily.
- The maximum possible coefficient is lower with heavier filtering.
- The default coefficient is sufficient in simpler applications.
- You only require a higher coefficient in case of higher dynamics.
- Without the integral coefficient, you do not maintain any stationary accuracy, since the set velocity is not reached.

## 16.10 4: Position controller – Proportional coefficient

The following graphic shows the influence of the proportional coefficient on the position controller.

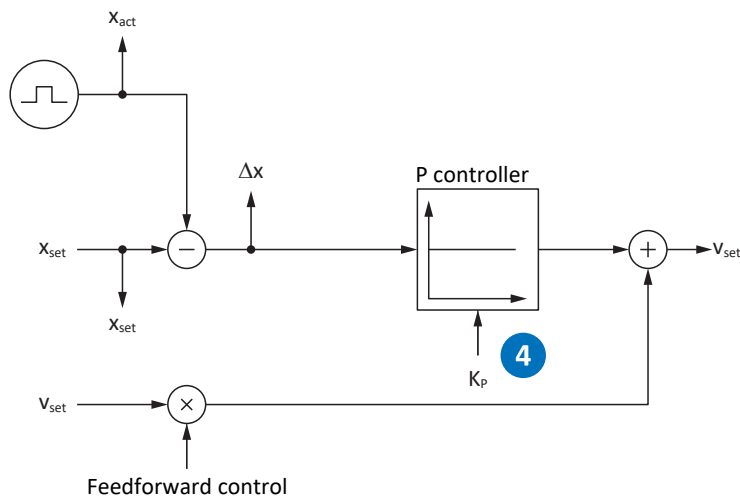

Fig. 69: Position controller – Proportional coefficient

The proportional coefficient  $K_p$  of the position controller can be defined in I20.

### Effects

A higher coefficient produces a lower following error, but the system becomes more sensitive.

### Procedure

1. Start with the default value for I20.
2. Increase the value of I20 up to the stability limit.
3. Define the value of I20 about 10% below the stability limit.

### Scope image

Requirements:

- I26 = 1: Position control
- C34 = Guide value or value taken from firmware
- C31 = Already optimized value
- C32 = Already optimized value
- I20 = e.g. 10, 20, and 50

Parameter for the scope image:

- I96 Reference position
- I80 Current position
- I84 Following error
- E06 V-reference motor
- E15 v-motor-encoder



## 16.11 5: Position controller – Velocity controller feedforward control

The following graphic shows the influence of the feedforward control on the position controller.

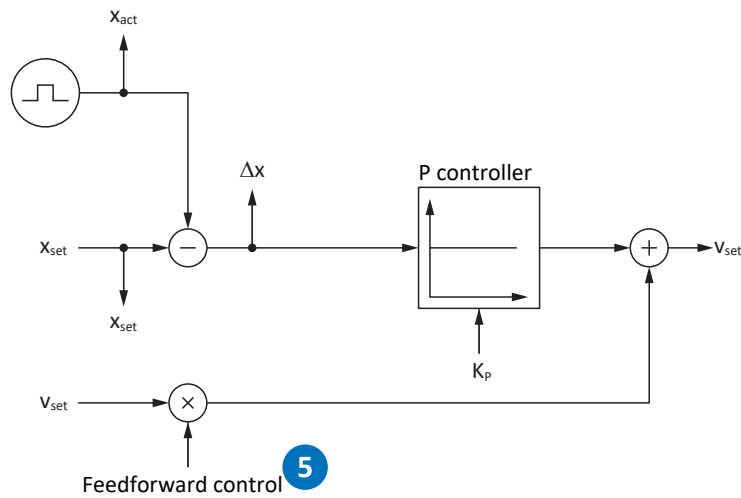

Fig. 70: Position controller – Feedforward control of the velocity controller

In case of external controller-generated or internal drive-generated feedforward control, the set velocity is also calculated in addition to the set position. In I25, you can define how much of that is directly communicated to the velocity controller.

### Effects

Feedforward control reduces the load of the position controller and reduces the following error; however, stronger feedforward control makes the system more sensitive.

### Procedure

1. Start with the default value of 95% for I25.
2. Reduce the value of I25 if the system is oscillating.

### Scope image

Requirements:

- I26 = 1: Position control
- C34 = Guide value or value taken from firmware
- C31 = Already optimized value
- C32 = Already optimized value
- I20 = Already optimized value
- I25 = e.g. 50 and 95%

Parameter for the scope image:

- I96 Reference position
- I80 Current position
- I84 Following error
- E06 V-reference motor
- E15 v-motor-encoder

## 16.12 Position controller – Summary

In summary, the following conclusions can be drawn for the optimization of the position controller:

- If the velocity controller is optimized, only small adjustments are required for the position controller.

## 16.13 Special cases

In the cases described below, additional parameters are relevant for optimization.

### 16.13.1 Current controller – Motor reaches saturation

Synchronous servo motors show a saturation effect at high currents.

#### Effects

Upon reaching the saturation limits, a higher motor current no longer generates higher field strength and it begins to fluctuate if the current continues to increase.

#### Procedure

1. Carry out the action B41 Calibrate motor.
  - ⇒ The electrical data of the motor is calibrated and the coefficients of the saturation characteristic are defined (B60).
2. Activate current control tracking in B59.
  - ⇒ The controller coefficients are tracked according to the saturation characteristic of the motor.

#### Scope image

Parameter for the scope image:

- E166 Iq-ref
- E93 Iq

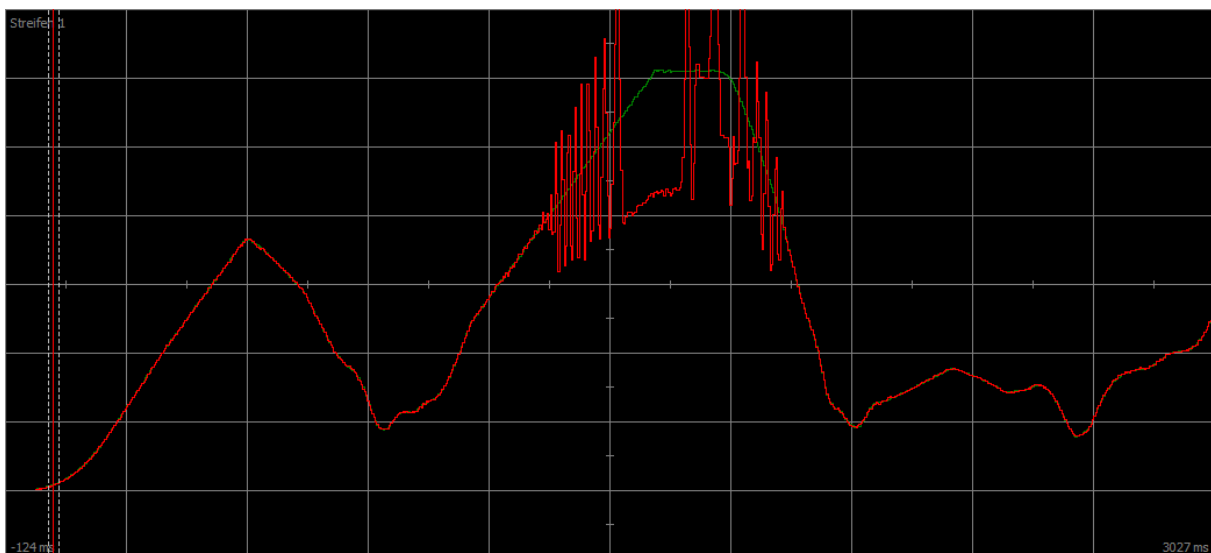

Fig. 71: Scope – Motor reaches saturation without tracking (B59)

Green      Set current  
Red        Actual current

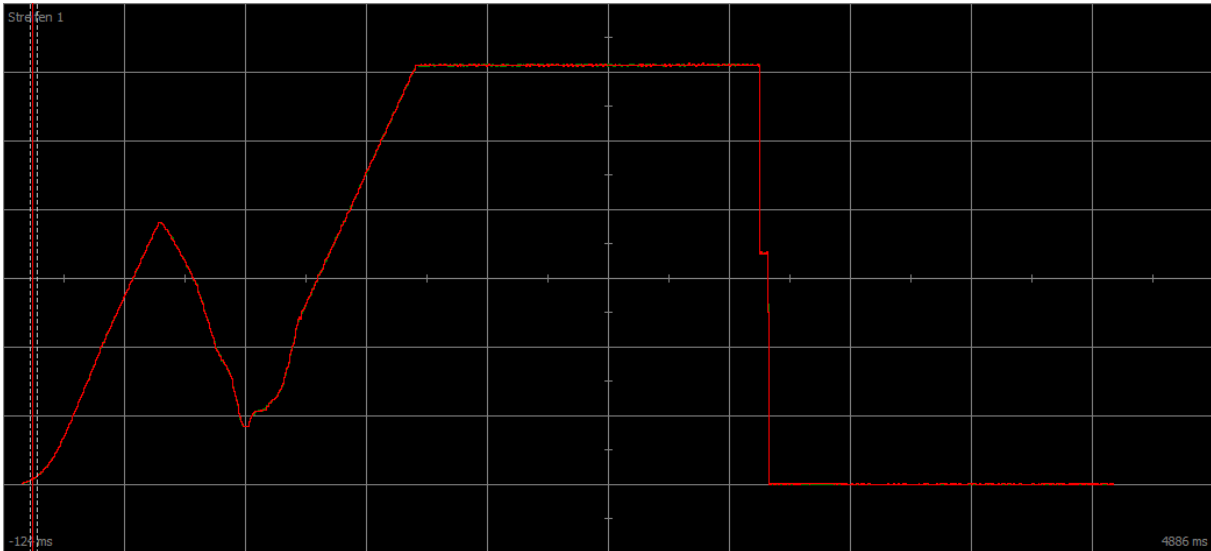

Fig. 72: Scope – Motor reaches saturation with tracking (B59)

Green      Set current  
Red        Actual current

### 16.13.2 Velocity controller – High set torque

C36 Reference torque/force low pass:

If the set torque becomes very high, such as in case of maximum utilization of the drive controller, the set torque can be filtered using this parameter. The filter prevents the overshooting of the torque and thus the occurrence of overcurrents. The effect of C36 is defined using C37.

### 16.13.3 Position controller – Friction or play

I23 Position controller deadband:

To prevent control oscillations due to friction or play in the mechanics, the position control can be deactivated in a narrow range using this parameter.

### 16.13.4 Position controller – Poor resolution

C33 Lowpass reference speed:

Using this parameter, the set velocity can be smoothed if the calculation of the set or actual position is too rough due to one of the following conditions:

- In case of controller-based applications with poor or low quantization of the set value
- In case of drive-based applications with poor resolution of the master encoder

# 17 Brake

The SD6 drive controller offers an option for both functional and safe brake management.

In combination with the ST6 option, the drive controller provides a functional brake test for the brake.

With the SE6 option, the drive controller offers safe brake management. Safe brake management fulfills the recommendations for gravity-loaded axes of DGUV Division Information Sheet 005/2012. It also fulfills the requirements for securing gravity-loaded axes from EN ISO 16090-1.

The following chapter describes the basic brake settings using the DriveControlSuite commissioning software and functional, non-safe brake management with one brake.

For detailed information on safe brake management, refer to the manual for the SE6 safety module (see [Detailed information \[▶ 476\]](#)).

Safety module	Application	Terminal(s)
ST6	Functional, non-safe brake management with one brake	X5
SE6	Functional, non-safe brake management with one brake	X5
SE6	Safe brake management with one brake	X8
SE6	Safe brake management with two brakes	X5 and X8

Tab. 284: Application cases for brake management

## CiA 402 application and gravity-loaded axes

<b>Information</b>
--------------------

If you are using a gravity-loaded axis and a brake, always use a quick stop to switch the drive (state transition 11 in accordance with the device state machine). This prevents the load from dropping until the brake is fully engaged.

For more detailed information on the CiA 402 application, refer to the corresponding manual (see [Detailed information \[▶ 476\]](#)).

## 17.1 Activating and selecting the brake

You activate the brake in parameter F00. You then select the brakes in F01.

1. Select the relevant drive controller in the project tree and click on the first projected axis in the project menu > Wizard area.
2. Select the Brake wizard.
3. F00 Brake:  
Select 1: Active if you are operating the motor in a regulated control mode and if the torque is to be saved at the time that the brake engages. In this case, the saved torque is restored before releasing the brakes. Select this option for gravity-loaded axes, for example.  
However, select 2: Do not save torque/force if only the motor magnetization is to be restored when the brake is released.
4. F01 Utilized brakes:  
Select 1: Brake 1 if the brake is connected to terminal X5.  
If the brake is connected to X8, select 2: Brake 2 (prerequisite: SE6 safety module).  
The 4: Brake 1 + 2 low frequency option is available if brakes are connected to X5 and X8 (prerequisite: SE6 safety module).
5. If necessary, store the release and engaging times of the brakes (see [Brake release time and brake engaging time](#) [▶ 290]).

## 17.2 Activating functional brake management

- ✓ You have activated and parameterized the brake.
1. Select the relevant drive controller in the project tree and click on the first projected axis in the Project menu > Wizard area.
  2. Select the Brake wizard > Brake control.
  3. B310 Brake management:  
Select 1: Global.
  4. B311 Timeout for brake test:  
Enter the time after which the drive controller is to output a message that a brake test is needed. You can set a maximum of 1 year = 52 weeks or 8760 hours of operating time.
  5. Transmit the configuration to the drive controller and save it in non-volatile memory (A00).
- ⇒ Brake management is activated.

## 17.3 Calibrate brake

For brakes with unknown release and engaging times, you can calibrate the release and engaging times, including the switching times of a contactor.

For more detailed information on the requirements as well as the exact procedure, see [Calibrating the brake \[▶ 292\]](#).



### Risk of fatal injury due to gravity-loaded vertical axis!

During this action, the brakes are released and movement starts. The motor cannot generate any or can only generate limited torque/force during this time. This can cause a gravity-loaded vertical axis to drop.

- Make sure that safe movement in the specified travel range is possible.
- Secure the area extending beyond the travel range for the case of further lowering of the gravity-loaded vertical axis.

✓ The drive controller is switched on.

1. Select the relevant drive controller in the project tree and click on the first projected axis in the Project menu > Wizard area.
2. Select the Brake wizard > Test brake.
3. B306 Permitted direction for actions of the brake:  
Define the permitted travel direction. Calibration only takes place in one travel direction. If both directions of rotation are permitted, travel proceeds in the positive direction.
4. B307 Standstill window brake test:  
Enter the angle of rotation that the drive evaluates as a standstill.
5. Select the Calibrate brake wizard.
6. Click Calibrate release/engaging time for brake.
  - ⇒ Calibration of the brake is executed.
  - ⇒ The determined times are stored in F04 and F05.
  - ⇒ F96[1] indicates the progress.
  - ⇒ F96[2] outputs the result of the action.
7. Afterwards, save the determined values in non-volatile memory (A00).

If two brakes are parameterized, the release and engaging times of both brakes are calibrated.

## 17.4 Testing a functional brake

Using the brake test, check whether the brake can still apply the required holding torque or holding force.

For more information on the test and calculation of test torques, see [Brake test \[► 295\]](#) and [Torque calculation \[► 296\]](#).

### DANGER!

#### Risk of fatal injury due to gravity-loaded vertical axis!

During this action, a test torque or test force is specified and the brakes are engaged. If the test torque/test force exceeds the holding torque/holding force of the brake, this results in movement of the axis. This can cause a gravity-loaded vertical axis to drop.

- Make sure that safe movement is possible.

### WARNING!

#### Injury to persons and material damage due to axis movement if test force exceeds holding ability!

Synchronous linear motors have high dynamics. A test force that cannot be maintained by the brake can result in a large travel path.

- Make sure that no people or objects are within the travel range.

- ✓ The drive controller is switched on.
  - ✓ The brake is activated and parameterized.
1. Select the relevant drive controller in the project tree and click on the first projected axis in the project menu > Wizard area.
  2. Select the Brake wizard > Test brake.
  3. B304 Positive torque/force limit for brake test:  
Enter the test torque or test force that that brake must hold in case of a positive direction of rotation.
  4. B305 Negative torque/force limit for brake test:  
Enter the test torque or test force that that brake must hold in case of a negative direction of rotation.
  5. E65 Current maximum positive torque/force:  
Make sure that the limit in the drive controller permits the value stored in B304.
  6. E66 Current maximum negative torque/force:  
Make sure that the limit in the drive controller permits the value stored in B305.
  7. B306 Permitted direction for actions of the brake:  
Define the permitted travel direction. If both directions of rotation are permitted, travel first proceeds in the positive direction.
  8. B307 Standstill window brake test:  
Enter the angle of rotation of the motor that the drive evaluates as a standstill.
  9. Click on Test brake.
- ⇒ The brake test is executed.
  - ⇒ B300[1] indicates the progress.
  - ⇒ B300[2] outputs the result of the action.

If two brakes are parameterized, both brakes are tested.

## 17.5 Bedding in the brake

By bedding in the brake, any deposits on the friction surface are removed that can negatively influence the holding function of the brake. For more information, see [Bedding in the brake](#) [▶ 298].

### DANGER!

#### Risk of fatal injury due to gravity-loaded vertical axis!

During this action, the brakes are released and movement starts. The motor cannot generate any or can only generate limited torque/force during this time. This can cause a gravity-loaded vertical axis to drop.

- Make sure that safe movement in the specified travel range is possible.
- Secure the area extending beyond the travel range for the case of further lowering of the gravity-loaded vertical axis.

- ✓ The drive controller is switched on.
  - ✓ The brake is activated and parameterized.
1. Select the relevant drive controller in the project tree and click on the first projected axis in the project menu > Wizard area.
  2. Select the Brake wizard > Bend in brake.
  3. B306 Permitted direction for actions of the brake:  
Define the permitted travel direction. If both directions of rotation are permitted, travel first proceeds in the positive direction.
  4. B308 Number of intervals for grind:  
Enter how often the brake is to engage when rotating in one direction.
  5. B309 Number of cycles for grind:  
Enter how often the drive is to bed in in any direction.
  6. Click on Bed in brake.
- ⇒ The bedding in of the brake is executed.
  - ⇒ B301[1] indicates the progress.
  - ⇒ B301[2] outputs the result of the action.



## 17.6 Bedding in brake 2

By bedding in the brake, any deposits on the friction surface are removed that can negatively influence the holding function of the brake. For more information, see [Bedding in the brake \[▶ 298\]](#).

Brake 2 is available exclusively in combination with the SE6 safety module.



### Risk of fatal injury due to gravity-loaded vertical axis!

During this action, the brakes are released and movement starts. The motor cannot generate any or can only generate limited torque/force during this time. This can cause a gravity-loaded vertical axis to drop.

- Make sure that safe movement in the specified travel range is possible.
- Secure the area extending beyond the travel range for the case of further lowering of the gravity-loaded vertical axis.

- 
- ✓ The drive controller is switched on.
  - ✓ Brake 2 is activated and parameterized.
1. Select the relevant drive controller in the project tree and click on the first projected axis in the project menu > Wizard area.
  2. Select the Brake wizard > Bend in brake 2.
  3. B306 Permitted direction for actions of the brake:  
Define the permitted travel direction. If both directions of rotation are permitted, travel first proceeds in the positive direction.
  4. B308 Number of intervals for grind:  
Enter how often the brake is to engage when rotating in one direction.
  5. B309 Number of cycles for grind:  
Enter how often the drive is to bed in in any direction.
  6. Click on Bed in brake 2.
- ⇒ The bedding in of the brake is executed.
  - ⇒ B302[1] indicates the progress.
  - ⇒ B302[2] outputs the result of the action.

## 17.7 More about the brake?

The following chapters summarize the important terms and settings.

### 17.7.1 Brakes used

The functions described in the following chapters apply to internal brake control. For external brake control (CiA 402), the brake is exclusively actuated by parameter and does not engage automatically in case of fault.

With external brake control, brake 2 behaves like brake 1, i.e. the control always makes both brakes release and engage together.

Brake 2 is available exclusively in combination with the SE6 safety module. If using 2 brakes or using brake 2, read the manual for the SE6 safety module (see [Detailed information](#) [▶ 476]).

#### Information

To protect the holding brake, avoid engaging a brake when an axis is moving:

- Always carry out an SS1 before an STO for this reason.
- If you would like to deactivate the enable signal for a moving axis, select A44 = 1: Active (default) so that a quick stop is carried out with Enable-off.
- As a fault response, always select a quick stop (A29 = 1: Active, default) or emergency braking (U30 = 1: Active).

#### 17.7.1.1 Operation with 1 brake (F01 = 1: Brake 1)

After Enable-on, the brake releases along with the first command and remains released until one of the following events occurs:

- Event with fault response:
  - The power unit is disabled and axis movement is no longer controlled by the drive controller
  - Quick stop
  - Emergency braking
- Enable-off
- Quick stop signal
- Brake is engaged at the end of the motion command (CiA 402 or PROFIdrive: I410 = 1: Active; DB: parameter depends on operating mode):
  - 1: MC\_MoveAbsolute
  - 2: MC\_MoveRelative
  - 3: MC\_MoveAdditive
  - 5: MC\_Stop
  - 6: MC\_Home (requirement: I30 ≠ 5: Define home)
  - 11: MC\_Halt
- STO with optional engaging of brake (prerequisite: SE6)

Regardless of this, the brake can be released long-term for commissioning or for service work by means of a release override. This must be defined in parameter F06 (signal: F07).

The behavior of the brake can be parameterized for the STO safety function. A requirement for this is the parameterization of the SS1 safety function in the SE6 safety module.

### Information

When the SE6 safety option is used, then the brake can be released for STO by a release override only if this is permitted by the settings for the SS1 safety function. For more information, refer to the manual for the SE6 safety module (see [Detailed information \[▶ 476\]](#)).

The 24 V<sub>DC</sub> supply to the brake and the short circuit are monitored. The monitoring can be adjusted or switched off in F93 or F100 (prerequisite: SE6). Furthermore, the brake connection to terminal X5 is checked for plausibility. The internal brake control monitors adherence to the release time and engaging time.

### 17.7.1.2 Operation with 1 brake (F01 = 2: Brake 2)

In combination with the SE6 safety module, you also have the option of using brake 2 as the only brake. This is only relevant if only one brake is available and it must be safely controlled and monitored.

### Information

For the use of 2 brakes or of brake 2, an SBC safety function must be parameterized. For more information, refer to the manual for the SE6 safety module (see [Detailed information \[▶ 476\]](#)).

After Enable-on, brake 2 releases along with the first command and remains released until one of the following events occurs:

- Event with fault response:
  - The power unit is disabled and axis movement is no longer controlled by the drive controller
  - Quick stop
  - Emergency braking
- Enable-off
- Quick stop signal
- Brake is engaged at the end of the motion command (CiA 402 or PROFIdrive: I410 = 1: Active; DB: parameter depends on operating mode):
  - 1: MC\_MoveAbsolute
  - 2: MC\_MoveRelative
  - 3: MC\_MoveAdditive
  - 5: MC\_Stop
  - 6: MC\_Home (requirement: I30 ≠ 5: Define home)
  - 11: MC\_Halt
- STO

Brake 2 cannot be released by a release override for STO and is monitored by the SE6 safety module. The internal brake control only monitors adherence to the release time and engaging time.

### 17.7.1.3 Operation with 2 brakes (F01 = 4: Brake 1 + 2 low frequency)

In combination with the SE6 safety module there is the option for implementing a concept with 2 brakes for safety-relevant applications. Brake 1, typically the motor holding brake, is used for frequent and fast switching during stalled motion. Brake 2, usually an external auxiliary brake with significantly higher switching times, remains open as a rule and is closed only in cases of exception. In this case, brake 1 is engaged for any intermediate stops required during working mode and brake 2 additionally ensures a secure hold during a prolonged stop, switched-off enable signal, STO or fault. Since the switching frequency of brake 2 can be substantially lower than the switching frequency of brake 1 as a result, a higher value can be achieved for the mean time to dangerous failure (MTTF<sub>b</sub>).

#### Information

For the use of 2 brakes or of brake 2, an SBC safety function must be parameterized. For more information, refer to the manual for the SE6 safety module (see [Detailed information](#) [▶ 476]).

For Enable-on, brake 2 releases and remains released until one of the following events occurs:

- Event with fault response:
  - The power unit is disabled and axis movement is no longer controlled by the drive controller
  - Quick stop
  - Emergency braking
- Enable-off
- Quick stop signal
- Movement detected despite brake 1 being engaged
- STO

After Enable-on, brake 1 releases along with the first command and remains released until one of the following events occurs:

- Event with fault response:
  - The power unit is disabled and axis movement is no longer controlled by the drive controller
  - Quick stop
  - Emergency braking
- Enable-off
- Quick stop signal
- Brake is engaged at the end of the motion command (CiA 402 or PROFIdrive: I410 = 1: Active; DB: parameter depends on operating mode):
  - 1: MC\_MoveAbsolute
  - 2: MC\_MoveRelative
  - 3: MC\_MoveAdditive
  - 5: MC\_Stop
  - 6: MC\_Home (requirement: I30 ≠ 5: Define home)
  - 11: MC\_Halt
- STO with optional engaging of brake (prerequisite: SE6)

The drive controller has a monitoring function that checks the standstill of the axis. If it is determined that the position has been left after brake 1 is engaged, then brake 2 engages as quickly as possible. Define the standstill window in parameter B307. In the event of a fault or emergency braking at the rotating axis, both brakes will engage at different times to prevent a shaft break caused by too much force from both brakes acting simultaneously.

## 17.7.2 Direct and indirect brake connection

The SD6 drive controller provides the option of directly connecting a 24 V<sub>DC</sub> brake with a current draw of up to 3 A (X5) or 3.6 A (X8). Brakes with a different supply voltage or higher current draw can be connected indirectly through a contactor.

### Drive controller with ST6 option

You have the following options for the connection:

- Directly to X5 (with or without monitoring)
- Indirectly to X5 (with or without feedback via X6)

Define the connection type of the brake at X5 in parameter F93.

### Drive controller with SE6 option

In combination with the SE6 safety module you have the following options:

- Directly to X5 (with or without monitoring)
- Indirectly to X5 (without feedback)
- Directly to X8 (with or without monitoring)
- Indirectly to X8 (with or without feedback via X14)

Define the connection type of the brake at X5 in parameter F100. Define the connection type for X8 in PASmotion.

## 17.7.3 Internal and external brake control

For the CiA 402 application, parameter F92[0] offers the option of switching from internal (automatic) brake control through the drive controller to external brake control through a controller.

In combination with the SE6 safety module, the advanced safety technology can intervene even for external brake control. For all other cases:

### **WARNING!**

#### **Injury to persons and material damage due to axis movement!**

For external brake control, the brake does not engage automatically in the event of faults or Enable-off. For Enable-on or the start of a motion, the brake is not automatically released. The external brake control is independent of the device state and motion core through the controller.

- Guarantee a suitable process in the controller and take suitable measures to ensure safety.
- When releasing the brake, also take into account the motor-side requirements (e.g. required time for building up magnetization in the case of asynchronous motors or for position determination in the case of Lean motors).

In parameter F06, define the source of the digital signal through which the brakes are released unconditionally. In the CiA 402 application, F06 = 2: Parameter is preset.

The controller can check whether the brakes are engaged or released (E201, bits 3 and 4) before position and speed set values are specified.

The following table shows the correlation between parameters F06 and F92[0].

F06 =	F92[0] =	Brake control
3: DI1 – 28: DI13 inverted	0: Internal (automatic)	Internal automatic system; release override through terminal input (source: E19)
3: DI1 – 28: DI13 inverted	1: External (plc)	Externally through terminal input (source: E19); no release override
2: Parameter	0: Internal (automatic)	Internal automatic system; release override through parameter (source: Drive Based A180, bit 6/CiA 402 A515, bit 14)
2: Parameter	1: External (plc)	Externally through parameter (Drive Based A180, bit 6/CiA 402 A515, bit 14); no release override

Tab. 285: Correlation between F06 and F92[0]

In the CiA 402 application, bit 14 of parameter A515 is the source of F92[1]. In the Drive Based application, bit 6 of parameter A180 serves as the source of F92[1].

F92[2] shows the current setting of the brake control.

### 17.7.4 Brake control based on control mode

The following chapters show the brake control depending on the control mode (B20) for one to two brakes with internal brake control through the drive controller.

#### 17.7.4.1 B20 = 0 or 1

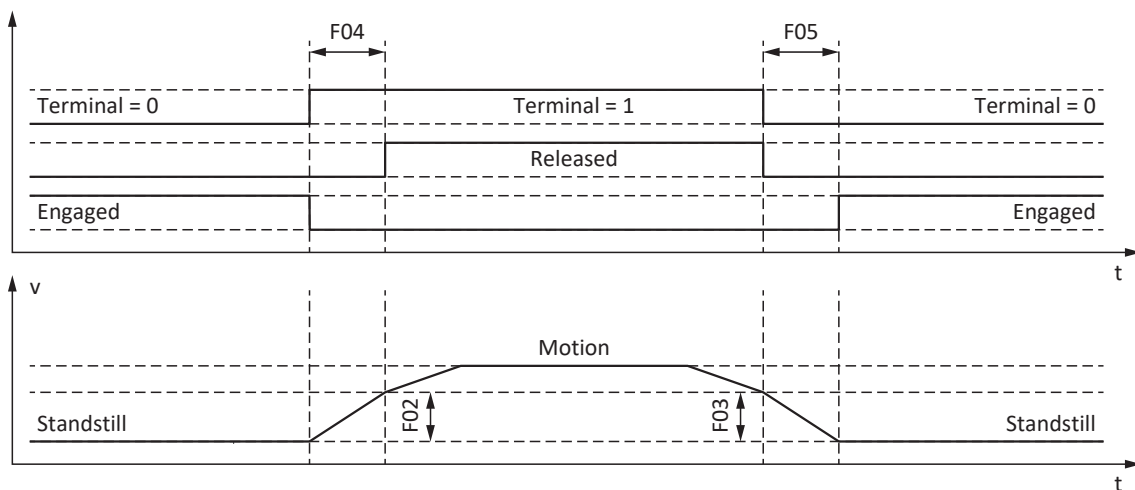

Fig. 73: Brake control for control mode B20 = 0: ASM - V/f-control or 1: ASM - V/f-slip compensated

In these control modes for asynchronous motors without a motor encoder, the axis is controlled to move within the release time F04.

Here, F02 is the velocity of the asynchronous motor that is built up during the release time F04. F03 is the velocity starting from which the brakes are controlled to engage.

During the release process, a set acceleration calculated from the velocity and release time takes effect (F02, F04). During the engaging process, a set deceleration calculated from the velocity and engaging time takes effect (F03, F05).

## 17.7.4.2 B20 = 2

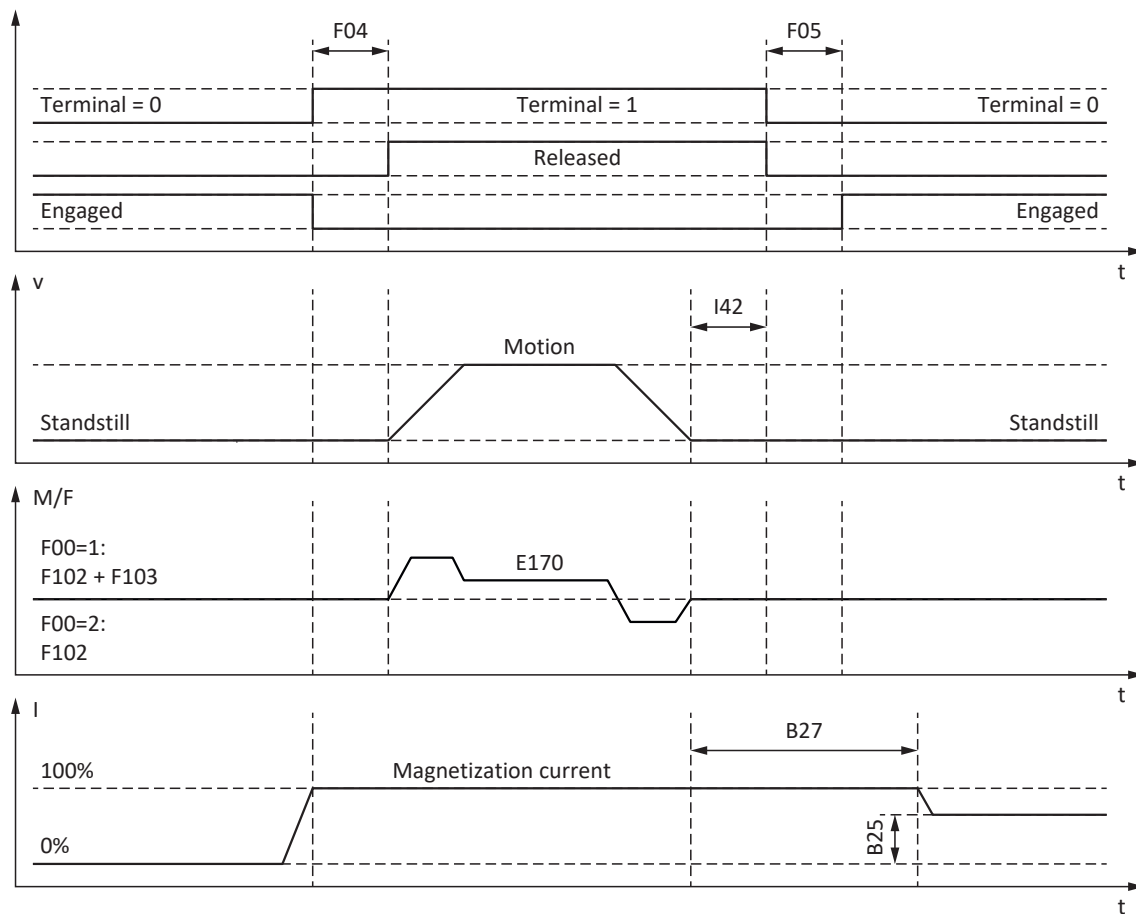

Fig. 74: Brake control for control mode B20 = 2: ASM - vector control

In this control mode for asynchronous motors with a motor encoder, the axis is controlled to move after the release time F04 has expired.

In the motion block and command operating modes, you can define a wait time for the brake to engage at the end of the motion command in parameter I42 (J27, J53). When this is done, multiple motion commands can be executed in succession without interruption from the brake engaging.

For specification of torque/force, E170 is the currently required set torque or the currently required set force  $M/F_{set}$  of the motor control (limit: E65, E66).

In F102, define a static feedforward control for torque/force for the velocity controller if you would like to set a base load for gravity-loaded axes. Depending on the boundary conditions of the machine, it may make sense to use different settings. For commissioning recommendations for gravity-loaded axes, see [Special case of load changes when the power unit is switched off \[► 299\]](#).

The torque or force for the next brake release process F103 is determined automatically and can be stored in non-volatile memory.

F103 is determined only for steady-state control and a completely released brake (F09) if the actual velocity of the motor encoder is less than the velocity window ( $|E15| < |C40|$ ).

The hold magnetization B25 ensures that the motor is still supplied with current when the brake is engaged. The magnetization is reduced as soon as the motor has come to a standstill and the wait time B27 has expired.

B25 influences the thermal machine utilization. The thermal machine utilization is reduced as B25 decreases, but the reaction time simultaneously increases as the brakes are released.

17.7.4.3 B20 = 3

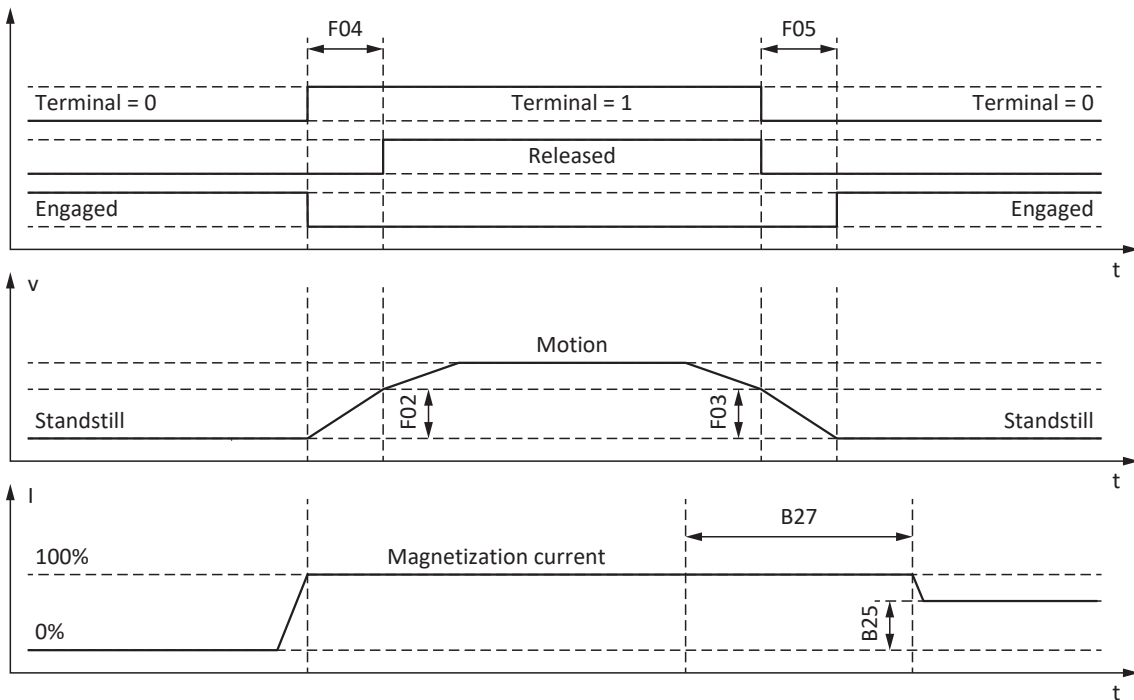

Fig. 75: Brake control for control mode B20 = 3: ASM - sensorless vector control

In this control mode for asynchronous motors without a motor encoder, the axis is controlled to move within the release time F04.

Here, F02 is the velocity of the asynchronous motor that is built up during the release time F04. F03 is the velocity starting from which the brakes are controlled to engage.

During the release process, a set acceleration calculated from the velocity and release time takes effect (F02, F04). During the engaging process, a set deceleration calculated from the velocity and engaging time takes effect (F03, F05).

The hold magnetization B25 ensures that the motor is still supplied with current when the brake is engaged. The magnetization is reduced as soon as the motor velocity has undershot the brake-engaging velocity F03 and the wait time B27 has expired.

B25 influences the thermal machine utilization. The thermal machine utilization is reduced as B25 decreases, but the reaction time simultaneously increases as the brakes are released.



17.7.4.4 B20 = 48, 64 or 70

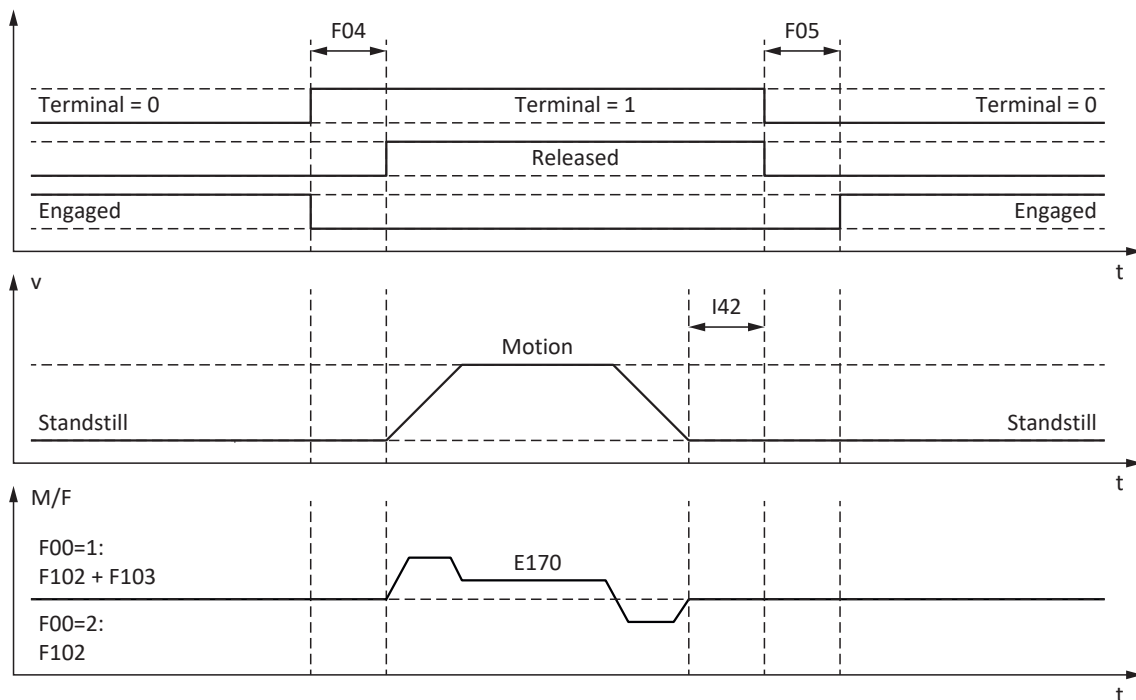

Fig. 76: Brake control for control mode B20 = 48: SSM-vector control incremental encoder, 64: SSM - vector control or 70: SLM - vector control

In these control modes for synchronous servo motors or synchronous linear motors with a motor encoder, the axis is controlled to move after the release time F04 has expired.

In the motion block and command operating modes, you can define a wait time for the brake to engage at the end of the motion command in parameter I42 (J27, J53). When this is done, multiple motion commands can be executed in succession without interruption from the brake engaging.

For specification of torque/force, E170 is the currently required set torque or the currently required set force  $M/F_{set}$  of the motor control (limit: E65, E66).

In F102, define a static feedforward control for torque/force for the velocity controller if you would like to set a base load for gravity-loaded axes. Depending on the boundary conditions of the machine, it may make sense to use different settings. For commissioning recommendations for gravity-loaded axes, see [Special case of load changes when the power unit is switched off \[► 299\]](#).

The torque or force for the next brake release process F103 is determined automatically and can be stored in non-volatile memory.

F103 is determined only for steady-state control and a completely released brake (F09) if the actual velocity of the motor encoder is less than the velocity window ( $|E15| < |C40|$ ).

## Commutation finding process using Wake and Shake in combination with a brake



### Risk of fatal injury due to gravity-loaded vertical axis!

Gravity-loaded axes can sink during a commutation finding process using Wake and Shake because the brake for the commutation finding process has to be released.

- Use the 48: SSM-vector control incremental encoder and 70: SLM - vector control control modes in combination with a commutation finding process using Wake and Shake only for axes without a gravity load.
- For gravity-loaded axes, use motors with an absolute encoder.

For a commutation finding process using Wake and Shake in combination with a brake, adhere to the following steps each time after restarting the drive controller:

1. Release brake using release override (F06)
2. Switch on the power unit (via Enable-on when G90 = 1: Position control or 2: Velocity control; with the first motion command when G90 = 0: Inactive)
3. Check E85 (2: Commutation OK = commutation succeeded; 0: Commutation unknown = commutation failed)
4. Use F06 to let the brake engage again

## 17.7.5 Brake release time and brake engaging time

The release times of the connected brakes are defined in parameter F04, the engaging times are defined in parameter F05:

- F04[0]: release time for brake 1
- F04[1]: release time for brake 2
- F05[0]: engaging time for brake 1
- F05[1]: engaging time for brake 2

When the motion start is activated after Enable-on, the motion and the status signals are delayed by the time F04 to prevent motion against a brake that has not yet opened completely.

When the brake engages, the control still remains active for the time F05 to prevent a gravity-loaded axis from sinking. For STO, the brake engages immediately. The behavior for deactivation of the enable signal can be defined with A44 (brake engages immediately or after a quick stop).

### Motors with an electronic nameplate

In motors with an electronic nameplate, the values during initial coupling of the motor and drive controller or when the action B06 is started are taken over from the electronic nameplate (prerequisite: B04 = 64: Active).

If the electronic nameplate also contains the release time and engaging time of the brakes integrated into the motor adapter (ServoStop), then these are also taken into account. The following additional setting is required for this, up to and including firmware V 6.5-H: B28 = 1: All data.

Sources for the values from the electronic nameplate:

- R50: nameplate release time of the motor brake
- R51: nameplate engaging time of the motor brake
- R67: nameplate release time of the motor adapter brake
- R68: nameplate engaging time of the motor adapter brake

### Motors without an electronic nameplate

Depending on the connection type, you have to calculate the release time and engaging time of the brake differently.

For a **direct connection**, the following guide values apply:

- $F04 = 1.3 \times t_{2B}$
- $F05 = 1.3 \times t_{1B}$

$t_{2B}$  and  $t_{1B}$  refer to the technical data for the brake specified in the STOBER catalog.

For an **indirect connection** of the brake through a contactor, additionally take into account  $1.2 \times$  the switching time of the contactor for both the release time and the engaging time.

If you do not know the release time and engaging time of the brake, you can calibrate these using the action F96.

## 17.7.6 Time between 2 release processes

### Information

The time between two brake release processes must be at least 1 s. If this is not observed, the 2nd release process will be delayed.

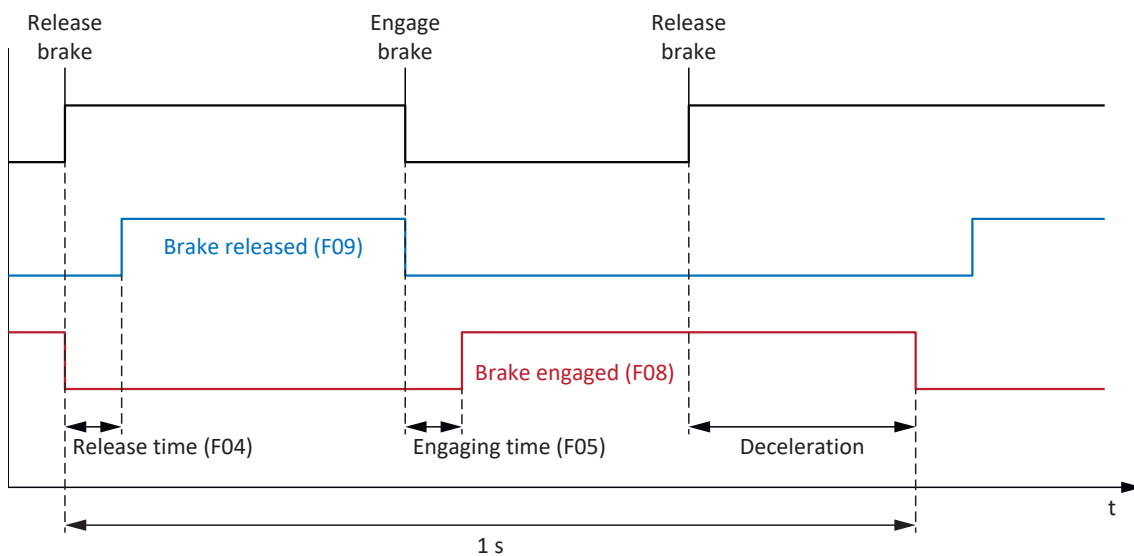

Fig. 77: Minimum time between two release processes for the brake

## 17.7.7 Calibrating the brake

With the action F96, you can calibrate the release and engaging times of the brake, including the switching times of a contactor. This action is not required for motors with an electronic nameplate because these values are taken over from the electronic nameplate during initial coupling of the motor for the drive controller.



### Risk of fatal injury due to gravity-loaded vertical axis!

During this action, the brakes are released and movement starts. The motor cannot generate any or can only generate limited torque/force during this time. This can cause a gravity-loaded vertical axis to drop.

- Make sure that safe movement in the specified travel range is possible.
- Secure the area extending beyond the travel range for the case of further lowering of the gravity-loaded vertical axis.

### Requirements

The action F96 requires a position encoder and is permitted only in the following control modes (B20):

- 2: ASM - vector control
- 3: ASM - sensorless vector control
- 48: SSM-vector control incremental encoder
- 64: SSM - vector control
- 70: SLM - vector control

F96 can be carried out also for loaded axes. In this case, the velocity controller should be optimized and the load must not be more than 2/3 of the maximum torque or force currently permitted (E65, E66).

### Required parameters

Define the permitted direction of motion for calibrating the brake in parameter B306, the standstill window in parameter B307.

The travel range is approximately 2.0 motor revolutions. To determine the travel path exactly, please include the gear unit and feed in the calculation.

### Sequence of the action

During the action, the axis rotates at 20 rpm. Initially, for a released brake, a measurement run is carried out for the duration of 1 s. Then the axis moves against the engaging brake. After detection of the brake engaging (timeout 2 s), the axis stops. This is followed by a standstill of 2 s (recovery phase). Then the axis moves against the releasing brake. After detection of the brake release (timeout 2 s), the axis continues moving for 0.5 s and then stops.

If two brakes are connected, the action F96 is always carried out for both brakes.

The determined times are stored in F04 and F05:

- F04[0]: release time for brake 1
- F04[1]: release time for brake 2
- F05[0]: engaging time for brake 1
- F05[1]: engaging time for brake 2

### Saving values

For the measured values to be saved in non-volatile memory, the action A00 has to be carried out after this.

Alternatively, the action B06 can be used to retrieve the values from the electronic nameplate, provided that it contains the brake data.

### Results

After the action F96 is started, the progress can be observed in parameter F96[1], and after the action is completed, F96[2] can be used to call up the results of calibrating.

The action F96 evaluates the measured time with the safety factor of 1.2. This means that the values entered in F04 and F05 are 1.2 times greater than the actually measured values.

## 17.7.8 Functional brake management

The functional brake management monitors the regular performance of brake tests to check whether the brake is functioning properly. The drive controller offers the following options through the axis management:

- **Single-axis operation:**  
One axis projected in the DriveControlSuite is used on a connected motor
- **Multi-axis operation:**  
Two, three or four axes projected in the DriveControlSuite are used on a connected motor

### Information

For **multi-axis operation**, you have to configure all settings in the parameters of Axis 1 in DriveControlSuite and select Axis 1 for actions.

The brake management can be used only if the following requirements are met:

- Self-engaging brakes are used, which brake in the de-energized state
- The drive has an encoder because no brake test can be carried out without an encoder

For detailed information on safe brake management, refer to the manual for the SE6 safety module (see [Detailed information](#) [▶ 476]).

### 17.7.8.1 State machine of brake management

Brake management functions with the following state machine:

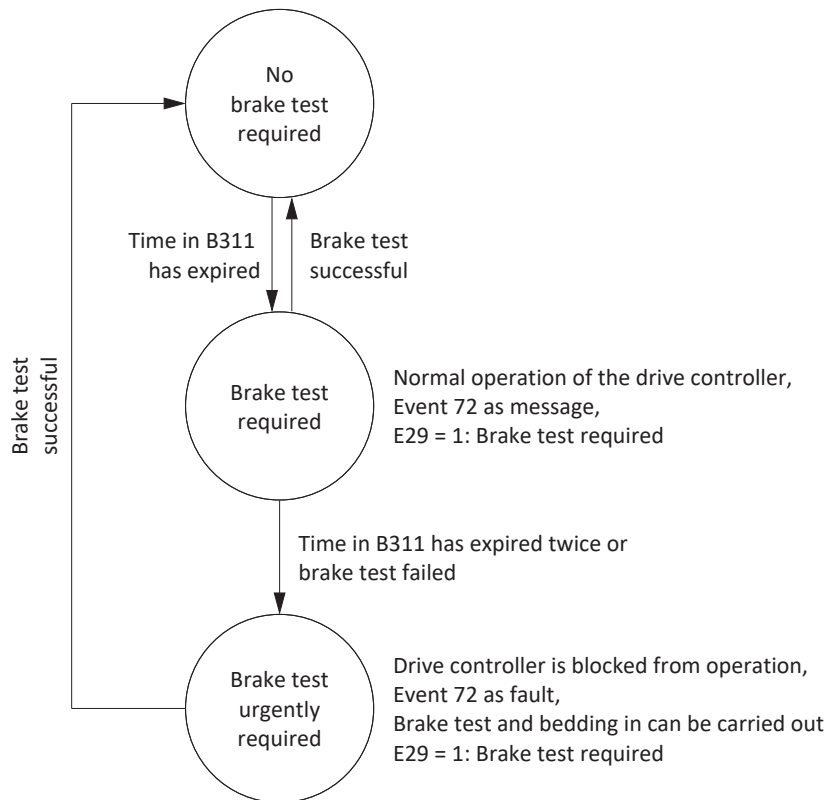

Fig. 78: State machine of brake management

The brake management time B311 begins to run starting from the time of activation. After the time expires, the brake management switches to the "Brake test required" state (E29 = 1: Brake test necessary, Event 72 as message with Cause 3). If you carry out a brake test successfully in this state, the brake management switches back to the "No brake test required" state (E29 = 0: Inactive) and the cycle B311 starts over.

If the state is "Brake test required" and the time B311 expires again without a brake test or the brake test was unsuccessful, the brake management switches to the "Brake test urgently required" state (fault E29 = 1: Brake test necessary, Event 72 as fault with Cause 1). To avoid interruption of the production process, the fault is not generated until the enable signal is switched off. The fault can be acknowledged to allow performance of the brake test and bedding in of the brake. However, if the brake test is not carried out successfully within 5 minutes after acknowledgment, the brake management switches back to the "Brake test urgently required" state. A successful brake test automatically leads back to the "No brake test required" state, and the cycle B311 starts over.

If a brake test is unsuccessful in the "Brake test urgently required" state, you can bed in the brakes and carry out the brake test again. If this brake test fails, too, then you have to replace the brake or the motor. The brake management remains in the "Brake test urgently required" state until a brake test has been carried out successfully after replacement of the brake or motor. The time that has passed since the last brake test is shown in parameter E177.

## 17.7.9 Brake test

The action B300 Test brake checks whether the brake can still apply the required holding torque or holding force.

### DANGER!

#### Risk of fatal injury due to gravity-loaded vertical axis!

During this action, a test torque or test force is specified and the brakes are engaged. If the test torque/test force exceeds the holding torque/holding force of the brake, this results in movement of the axis. This can cause a gravity-loaded vertical axis to drop.

- Make sure that safe movement is possible.

### WARNING!

#### Injury to persons and material damage due to axis movement if test force exceeds holding ability!

Synchronous linear motors have high dynamics. A test force that cannot be maintained by the brake can result in a large travel path.

- Make sure that no people or objects are within the travel range.

#### Requirements

The action B300 requires a position encoder and is permitted only in the following control modes (B20):

- 2: ASM - vector control
- 48: SSM-vector control incremental encoder
- 64: SSM - vector control
- 70: SLM - vector control

If you use a safety module with SBT safety function, then B300 and associated parameters are hidden and replaced by S18 as soon as the drive controller is online.

#### Required parameters

Enter the test torque or test force in the parameters B304 and B305:

- B304[0]: Positive set torque/positive set force for brake 1
- B304[1]: Positive set torque/positive set force for brake 2
- B305[0]: Negative set torque/negative set force for brake 1
- B305[1]: Negative set torque/negative set force for brake 2

Define the permitted travel direction in B306. If both directions of rotation are permitted, travel first proceeds in the positive direction. Enter the angle of rotation of the motor that the drive evaluates as a standstill in B307.

To define the test torques or test forces, note that the motor torque is limited to the values in C03 and C05. If larger values are entered in B304 and B305, they cannot be achieved. Furthermore, make sure that the limit in the drive controller permits the stored values. To do so, check the parameters E65 and E66 during the brake test.

#### Travel path for brake test

- Synchronous servo motors and asynchronous motors: If the brake can hold the test torque, then the maximum travel path is 0.125 motor revolutions.
- Synchronous linear motors: If the brake can hold the test force, then the maximum travel path is 0.8 mm.

## Sequence of the action

If the brake is released, then the encoder is tested first. For the encoder test, the motor rotates at approximately 60 rpm at a maximum of 45° in both directions of rotation. Then the brake engages and a parameterizable test torque or test force is applied to the drive in each permitted direction of rotation. If the drive detects motion, then the brake was unable to apply the required holding torque or holding force and the test has failed.

If two brakes are connected, the action B300 is always carried out for both brakes.

## Results

After the action B300 is started, the progress can be observed in parameter B300[1], and after the action is completed, B300[2] can be used to call up the test results.

## 17.7.10 Torque calculation

In the following chapters, you will find information for calculating the torques that you have to enter in B304 and B305 for the brake test.

### 17.7.10.1 Torques for synchronous servo motors

To calculate the torques, you need the following values:

- $M_B$ : Select the braking torque that you have designed and that is required for your application. Alternatively, perform a calculation using the static braking torque of the motor brake  $M_{Bstat}$  or of the motor adapter brake  $M_{1Bstat}$
- $M_0$ : Stall torque
- $I_0$ : Stall current
- $I_{2N,PU}$ : Nominal output current of the drive controller

In the first step, calculate the ratio of torques as a percentage:

$$K = \frac{M_B}{M_0} \times 100 \%$$

In the next step, determine the current for  $M_B$ :

$$I = I_0 \times K$$

Compare  $I$  to  $I_{2N,PU}$  of the drive controller:

If  $I \leq 2 \times I_{2N,PU}$ , then:

$$B304 = K \text{ and } B305 = -K$$

If  $I > 2 \times I_{2N,PU}$ , then the drive controller cannot generate the test torque that you have designed.

### Example

- $M_B = 10 \text{ Nm}$
- $M_0 = 6.6 \text{ Nm}$
- $I_0 = 4.43 \text{ A}$
- $I_{2N,PU} = 6 \text{ A}$

$$K = \frac{10 \text{ Nm}}{6,6 \text{ Nm}} \times 100 \% = 151 \%$$

$$I = 4.43 \text{ A} \times 151 \% = 6.69 \text{ A}$$

$$I = 6.69 \text{ A} < 2 \times I_{2N,PU} = 12 \text{ A}$$

Results: B304 = 151% and B305 = -151%



To define the test torques or test forces, note that the motor torque is limited to the values in C03 and C05. If larger values are entered in B304 and B305, they cannot be achieved. Furthermore, make sure that the limit in the drive controller permits the stored values. To do so, check the parameters E65 and E66 during the brake test.

### 17.7.10.2 Torques for asynchronous motors

To calculate the torques, you need the following values:

- $M_B$ : Select the braking torque that you have designed and that is required for your application. Alternatively, perform a calculation with the nominal braking torque of the motor brake  $M_{N,B}$
- $M_N$ : Nominal torque of the motor
- $M_k/M_N$ : Ratio of breakdown torque to nominal torque
- $I_{2N,PU}$ : Nominal output current of the drive controller
- $I_{d,ref}$  (E171): Magnetization-generating reference current in the d/q coordinate system
- $I_{q,ref}$  (E172): Torque/force-generating reference current in the d/q coordinate system

To obtain the correct values from E171 and E172, complete the project configuration of the motor, transfer the project to the drive controller and save it. Then read out the values in online operation.

In the first step, calculate the ratio of torques as a percentage:

$$K = \frac{M_B}{M_N} \times 100 \%$$

If  $M_k/M_N < 2$ , select  $K = M_k/M_N \times 100 \%$ .

In the next step, determine the current for  $M_B$ :

$$I = \sqrt{I_{d,ref}^2 + (K \times I_{q,ref})^2}$$

Compare  $I$  to  $I_{2N,PU}$  of the drive controller:

If  $I \leq 1.8 \times I_{2N,PU}$ , then:

B304 =  $K$  and B305 =  $-K$

If  $I > 1.8 \times I_{2N,PU}$ , then the drive controller cannot generate the test torque that you have designed.

#### Example

- $M_B = 10 \text{ Nm}$
- $M_0 = 5.12 \text{ Nm}$
- $M_k/M_N = 2.3$
- $I_{2N,PU} = 2.3 \text{ A}$
- $I_{d,ref} = 1.383 \text{ A}$
- $I_{q,ref} = 1.581 \text{ A}$

$$K = \frac{10 \text{ Nm}}{5.12 \text{ Nm}} \times 100 \% = 195 \%$$

$$I = \sqrt{(1.383 \text{ A})^2 + (195 \% \times 1.581 \text{ A})^2} = 3.38 \text{ A}$$

$I = 3.38 \text{ A} < 1.8 \times I_{2N,PU} = 4.14 \text{ A}$

Results: B304 = 195% and B305 = -195%

To define the test torques or test forces, note that the motor torque is limited to the values in C03 and C05. If larger values are entered in B304 and B305, they cannot be achieved. Furthermore, make sure that the limit in the drive controller permits the stored values. To do so, check the parameters E65 and E66 during the brake test.

### 17.7.11 Bedding in the brake

For the actions B301 Grind brake and B302 Brake 2 grind, the brake repeatedly engages for approximately 0.7 s and then is released for approximately 0.7 s while the motor rotates at approximately 20 rpm. This grinds off any deposits on the friction surface that can negatively influence the holding function of the brake.

Brake 2 is available exclusively in combination with the SE6 safety module.



#### Risk of fatal injury due to gravity-loaded vertical axis!

During this action, the brakes are released and movement starts. The motor cannot generate any or can only generate limited torque/force during this time. This can cause a gravity-loaded vertical axis to drop.

- Make sure that safe movement in the specified travel range is possible.
- Secure the area extending beyond the travel range for the case of further lowering of the gravity-loaded vertical axis.

#### Required parameters

You can define the following parameters:

- How often the brake engages while rotating in one direction (B308)
- How often the drive should rotate in each direction (B309)
- Whether a direction of rotation is blocked (B306)

#### Set speed/velocity and travel range

- Synchronous servo motors, Lean motors and asynchronous motors:
  - Fixed set speed: 20 rpm
  - Travel range:  $B308 \times 0.5$  motor revolutions
- Synchronous linear motors:
  - Fixed set velocity: 20 m/min
  - Travel range:  $B308 \times 0.5$  m

#### Results

After the action is started, the progress can be observed in parameter B301[1] for brake 1 and in B302[1] for brake 2. After the action is completed, the result for brake 1 can be called up in B301[2] and for brake 2 in B302[2].

## 17.7.12 Special case of load changes when the power unit is switched off

Depending on the boundary conditions of the machine, it may make sense to use different settings.

### Recommendation for commissioning with gravity-loaded axes

If load changes occur only when the power unit is switched on and the control is set to be vibration-free, leave the presets.

On the other hand, if load changes also occur when the power unit is switched off, reduce the correcting process when the brakes are released:

1. F00 Brake:  
Select 2: Do not save torque/force to save F103 only in volatile memory.
2. F102 Torque/force feed forward:  
Specify the determined value for the base load so that the automatic determination in the event of a load change yields only the difference.
3. Reduce the correcting process when releasing the brakes by optimizing the velocity controller.

### Determining the base load

1. F102 Torque/force feed forward:  
Set the value to 0.0%.
2. Load the axis with the base load.
3. Select the Jog control panel wizard.
4. Enable the axis and let it stand in one position with released brakes in active position control.
5. Determine a stable value for E02 using a scope image; this value corresponds to the base load.
6. Select the Jog control panel wizard.
7. Deactivate the enable signal of the axis.
8. F102 Torque/force feed forward:  
Enter the determined base load.
9. A00 Save values:  
Save the value in non-volatile memory.

## 18 Predictive Maintenance

Predictive Maintenance (PMR) in the context of Industry 4.0 enables a machine to predict and signal the optimal time when components should be serviced or replaced.

Especially in industrial automation technology, geared motors are system-relevant components and therefore very important for predictive analysis. One way to infer the service life of a geared motor is based on the loads to which the gear unit is subjected during its lifetime.

STOBER Predictive Maintenance monitors your connected geared motor. Its life performance is calculated using a model-based analysis procedure and mapped in parameters. These parameters can be displayed via the higher-level controller or in the DriveControlSuite commissioning software. This allows you to plan maintenance optimally and proactively. The solution includes 3 essential components. The load matrix is a solid data base for recording the real-world load situations of your machine and improving quality and economic efficiency. The life performance indicator is the value for the calculated life performance of the geared motor. The recommendation to replace the geared motor can be displayed in DriveControlSuite and is also provided to the controller as a parameter that can be read out.

STOBER Predictive Maintenance is automatically active for STOBER geared motors with an electronic nameplate as of production date 04/2022. For geared motors from STOBER without an electronic nameplate or for older STOBER geared motors, monitoring can be activated manually in the DriveControlSuite commissioning software by using a wizard (V 6.5-G and later and associated firmware in V 6.5-G and later).

### Your advantages at a glance

- Prognosis of the optimal time for maintenance
- Extension of the maintenance intervals
- Reduction of spare part inventories through controlled procurement
- Service concepts

STOBER Predictive Maintenance requires no additional external sensors, no additional wiring and no additional components.

### 18.1 Legal disclaimer

As of 2022 in DriveControlSuite in V 6.5-G or later, functions that estimate the aging and wear of the components used have been implemented in the STOBER system.

The estimates are used to make various kinds of predictions to provide support for decisions about preventative replacement. This computer-based support is usually called Predictive Maintenance or something similar.

As development matures, this support is expected to become increasingly precise. On the one hand, this is partly due to the growing statistical knowledge of STOBER. On the other hand, the algorithms are also refined over time and the number of sensors used increases.

Nevertheless, statistical errors are to be expected. In principle, there are two types of errors:

- False positive: The algorithm predicts failure in the future, although damage has already occurred in the system.
- False negative: The algorithm recommends replacement although the service life is evidently still long.

By using this function, it is acknowledged that the occurrence of statistical errors is typical of the system and is not cause for any liability on the part of the manufacturer. There is no entitlement to compensation for damages due to a miscalculation by the algorithm.

## 18.2 Displaying the state

Open the corresponding wizard in DriveControlSuite if you want to check the state of Predictive Maintenance and the relevant parameters.

- ✓ The drive controller is switched on and connected to the network.
- ✓ There is an online connection between DriveControlSuite and the drive controller.
- 1. Select the respective drive controller in the project tree and in the Project menu > Wizard area click on the configured axis whose monitoring you would like to check.
- 2. Select the Predictive Maintenance wizard.
- ⇒ The state is displayed directly as an icon with a corresponding note.
- ⇒ R100 PM state:  
Indicates the state of Predictive Maintenance; if R100 = 0: Inactive, you must manually configure STOBER Predictive Maintenance.
- ⇒ R101 PM life performance indicator:  
Displays the calculated life performance of the geared motor; from a value  $\geq 90\%$ , replacement of the geared motor is recommended.
- ⇒ R112 PM gear unit designation:  
Displays the type designation of the geared motor being monitored in Predictive Maintenance.

## 18.3 Sending the load matrix

Open the associated wizard in DriveControlSuite and send the load matrix to STOBER, for example, if you need assistance with data analysis. With an existing online connection, parameter R118 is read from the drive controller and sent as a JSON file. In offline mode, you can send a load matrix already exported in JSON format.

### Information

It is not possible to infer specific machine cycles based on the load matrix. The load matrix contains only highly condensed, statistical features.

### Sending the load matrix

- ✓ The drive controller is switched on and connected to the network.
  - ✓ There is an online connection between DriveControlSuite and the drive controller.
1. Select the relevant drive controller in the project tree and in the Project menu > Wizard area click on the configured axis whose load matrix you want to send to STOBER.
  2. Select the Predictive Maintenance wizard.
  3. Click Send load matrix.
    - ⇒ The Send load matrix dialog box opens.
    - ⇒ The source, destination and amount of data of the current load matrix are displayed.
  4. Click Proxy settings.
    - ⇒ The Proxy settings dialog box opens.
  5. Select the desired option for the proxy setting.  
For manual proxy configuration:
    - 5.1. If you are using a proxy server, specify the name of the proxy server or the IP address in the address field and the port of the proxy server in the Port field.
    - 5.2. If you are using a proxy server with a login, also specify the username and password for login.
    - 5.3. Use Test connection to make sure that a connection to the proxy server is possible.
  6. Confirm with OK.
    - ⇒ The Proxy settings dialog box closes.
  7. In the Send load matrix dialog box, click Send.
    - ⇒ The sending process starts and the data is transmitted to STOBER.
  8. Close the dialog box after sending has been completed successfully.

### Sending the load matrix (export)

- ✓ You have exported the load matrix in JSON format.
- 1. Select the relevant drive controller in the project tree and in the Project menu > Wizard area click on the projected axis whose exported load matrix you want to send to STOBER.
- 2. Select the Predictive Maintenance wizard.
- 3. Click Send load matrix (export).
  - ⇒ The dialog box for selecting the file opens.
- 4. Navigate to the load matrix previously exported in JSON format and select it.
- 5. Click Open.
  - ⇒ The Send load matrix (export) dialog box opens.
  - ⇒ The source, destination and data volume of the current load matrix are displayed in the dialog box.
- 6. Click Proxy settings.
  - ⇒ The Proxy settings dialog box opens.
- 7. Select the desired option for the proxy setting.  
For manual proxy configuration:
  - 7.1. If you are using a proxy server, specify the name of the proxy server or the IP address in the address field and the port of the proxy server in the Port field.
  - 7.2. If you are using a proxy server with a login, also specify the username and password for login.
  - 7.3. Use Test connection to make sure that a connection to the proxy server is possible.
- 8. Confirm with OK.
  - ⇒ The Proxy settings dialog box closes.
- 9. In the Send load matrix dialog box, click Send.
  - ⇒ The sending process starts and the data is transmitted to STOBER.
- 10. Close the dialog box after sending has been completed successfully.

## 18.4 Exporting the load matrix

If you want to review or analyze the data, use the associated DriveControlSuite wizard to export the load matrix. If an online connection exists, parameter R118 is read directly from the drive controller for export. If the data in your project is already available in DriveControlSuite, you can also export the data in offline mode.

- 1. Select the relevant drive controller in the project tree and in the Project menu > Wizard area click on the projected axis whose load matrix you want to export.
- 2. Select the Predictive Maintenance wizard.
- 3. Click Export load matrix.
  - ⇒ The Export load matrix dialog box opens.
- 4. Select the directory to which you want to export the load matrix.
- 5. Select the desired file type (JSON or CSV).
- 6. Assign a file name and select `.json` or `.csv` as the file extension.
- 7. Confirm with Save.
  - ⇒ The load matrix is saved as a JSON or CSV file (\*.json, \*.csv).

## 18.5 Configuring Predictive Maintenance

STOBER Predictive Maintenance is automatically active for STOBER geared motors with an electronic nameplate as of production date 04/2022. Configure monitoring in DriveControlSuite only in the following cases:

- STOBER geared motors with a manufacturing date prior to 04/2022
- STOBER geared motors without an electronic nameplate

In the cases mentioned above, Predictive Maintenance is inactive. First check the status of Predictive Maintenance with an existing online connection (see [Displaying the state](#) [▶ 301]). If R100 = 0: Inactive, you can then carry out the manual configuration in offline mode.

### Configuring Predictive Maintenance via the serial number

- ✓ You have the serial number of the gear unit.
1. Select the relevant drive controller in the project tree and click on the first projected axis in the Project menu > Wizard area.
  2. Select the Predictive Maintenance wizard.
  3. Click Configure Predictive Maintenance (Internet).
    - ⇒ The Configure Predictive Maintenance (Internet) dialog box opens.
  4. Click Proxy settings.
    - ⇒ The Proxy settings dialog box opens.
  5. Select the desired option for the proxy setting.  
For manual proxy configuration:
    - 5.1. If you are using a proxy server, specify the name of the proxy server or the IP address in the address field and the port of the proxy server in the Port field.
    - 5.2. If you are using a proxy server with a login, also specify the username and password for login.
    - 5.3. Use Test connection to make sure that a connection to the proxy server is possible.
  6. Confirm with OK.
    - ⇒ The Proxy settings dialog box closes.
  7. Enter the serial number of your gear unit in the Configure Predictive Maintenance (Internet) dialog box.
  8. Click Start download.
    - ⇒ The data is downloaded and automatically written to the associated parameters.
  9. After a successful download, confirm with OK
    - ⇒ You have activated Predictive Maintenance.

Then transfer the configuration to the drive controller, save it and restart the drive controller (see Transmitting and saving the configuration).



## Configuring Predictive Maintenance manually

If automatic configuration via the serial number fails, you can alternatively configure Predictive Maintenance manually.

### Information

The required information can be found in the order confirmation for your gear unit, for example. Alternatively, you can scan the QR code on the nameplate or retrieve it online using the serial, delivery note or invoice number at:

<https://id.stober.com>.

- ✓ The order confirmation is available to you or you have access to the electronic product ID of your gear unit.
- 1. Select the relevant drive controller in the project tree and click on the first projected axis in the Project menu > Wizard area.
- 2. Select the Predictive Maintenance wizard.
- 3. Click Configure Predictive Maintenance (local).
  - ⇒ The Configure Predictive Maintenance (local) dialog box opens.
- 4. Click Proxy settings.
  - ⇒ The Proxy settings dialog box opens.
- 5. Select the desired option for the proxy setting.  
For manual proxy configuration:
  - 5.1. If you are using a proxy server, specify the name of the proxy server or the IP address in the address field and the port of the proxy server in the Port field.
  - 5.2. If you are using a proxy server with a login, also specify the username and password for login.
  - 5.3. Use Test connection to make sure that a connection to the proxy server is possible.
- 6. Confirm with OK.
  - ⇒ The Proxy settings dialog box closes.
- 7. Select the series of your gear unit.
- 8. Select the size of your gear unit.
- 9. Then select your gear unit from the list.
- 10. Confirm with OK.
  - ⇒ You have activated Predictive Maintenance manually.

Then transfer the configuration to the drive controller, save it and restart the drive controller (see Transmitting and saving the configuration).

The following tables provide an overview of the abbreviations used for manual configuration.

**Bearing design**

Abbreviation	Meaning
N	Standard bearing
V	Reinforced bearing (e.g: PH3 – PH5)
D	Axially reinforced bearing
Z	Radially reinforced bearing

Tab. 286: Bearing design features

**Shaft design**

Abbreviation	Meaning
A	Hollow shaft with keyway
S	Hollow shaft with shrink ring
SB	Hollow shaft S on both sides
V	Solid shaft with feather key
G	Solid shaft without a feather key
B	Solid shaft on both sides
Q	Solid shaft without key with transverse bore
P	Solid shaft with feather key
F	Flange shaft

Tab. 287: Shaft design features

**Shaft/pinion position**

Abbreviation	Meaning
00	Not applicable
A3	Hollow shaft entry side 3
A4	Hollow shaft entry side 4
G3	Solid shaft without a feather key side 3
G4	Solid shaft without a feather key side 4
S3	Shrink ring side 3
S4	Shrink ring side 4
S34	Shrink ring side 3 and 4
V3	Solid shaft side 3
V4	Solid shaft side 4

Tab. 288: Shaft/pinion position features

**Gear unit option**

Abbreviation	Meaning
00	Not applicable
T3	Crown gear side 3
T4	Crown gear side 4

Tab. 289: Gear unit option features

## 18.6 Information on activation, operation and replacement

Pay attention to the following information on activating STOBER Predictive Maintenance and for operating and replacing components.

### Activation

The following requirements apply for successful activation of STOBER Predictive Maintenance:

- STOBER system (consisting of drive controllers and geared motors from STOBER)
- Automatic activation for geared motors with a manufacturing date as of 04/2022
- Manual configuration required for geared motors with an older manufacturing date or geared motors without an electronic nameplate
- Inserted Paramodul for non-volatile storage of the load matrix
- No linear motor (control mode B20 ≠ 70: SLM - vector control)
- Gear units not connected in series, as this is not supported by the life performance indicator

### Operation

STOBER Predictive Maintenance is continued without interruption after restarting the drive controller if the following requirements are met:

- Paramodul permanently inserted in the drive controller
- Uninterrupted connection of drive controller and geared motor
- Constant gear ratio of the gear unit (Drive Based/PROFIdrive: C15, C16, CiA 402: A584)

### Replacement

After replacing the geared motor, a new record is created. The existing data is not overwritten. With the original data, the drive controller is able to continue monitoring the geared motor after the geared motor has been replaced.

After the drive controller has been replaced, monitoring can be continued without interruption by transferring the data from the Paramodul.

## 18.7 More about Predictive Maintenance?

The following chapters summarize the essential terms of STOBER Predictive Maintenance and provide you with further relevant information on the subject.

### 18.7.1 Load matrix

The load matrix represents the data base for recording the real-world load situations of machines and improving the quality and economic efficiency. It represents the frequency distribution of speeds and torques that occurred at the output of the geared motor. The load matrix and other information are stored in DriveControlSuite in parameter R118. The information relevant for Predictive Maintenance is also made available to the controller via this parameter.

#### Information

The load matrix is only recorded if the axis is enabled (A900 = 1).

The load matrix is stored in non-volatile memory on the Paramodul along with the life performance indicator every 30 minutes.

### Structure and scope

The load matrix divides speed and torque into equidistant classes. For the speed, 21 classes are available for both directions of rotation. The speed range covers -150% to +150% of the nominal speed. For the torque, 31 classes are available for the torque range from -250% to +250% of the nominal torque.

The nominal speed and nominal torque of the load matrix refer to the gear unit output of the geared motor.

The speed range includes:

$$-1.5 \times n_{2N} \text{ to } +1.5 \times n_{2N}$$

The speed is stored in rpm.

The torque range includes:

$$-2.5 \times M_{2N} \text{ to } +2.5 \times M_{2N}$$

The torque is stored in %. The reference value for the percentage torque value is C09.

Torques and speeds outside the respective specified range are assigned to the outermost class:

Values that fall below the lower limit are sorted into the lowest class. Values that exceed the upper limit are sorted into the highest class.

### Scaling

The recorded speed classes are scaled as follows, with the label representing the average of the two class limits in each case:

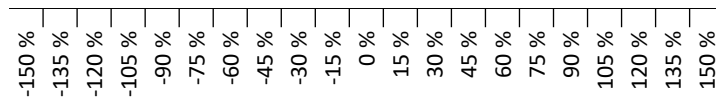

Fig. 79: Scaling of the recorded speed classes

The recorded torque classes are scaled as follows, with the label representing the average of the two class limits in each case:

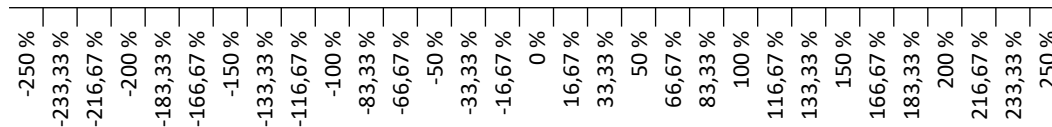

Fig. 80: Scaling of the recorded torque classes

### Data export or data transmission

From the DriveControlSuite commissioning software, the load matrix can be exported in JSON data format (\*.json) or in CSV data format (\*.csv).

Alternatively, you can send the load matrix to STOBER for analysis (see [Reading out and transmitting the load matrix \[▶ 313\]](#)).

### 18.7.1.1 Information on the load matrix

The load matrix is stored in DriveControlSuite in parameter R118 along with the life performance indicator in JSON data format. The parameter contains all the information necessary to understand the load matrix:

Key	Value	Description
"version"	String	Version name of the JSON format
"id"	String	ID for the type of JSON document
"mcgm-database-id"	Number	Database ID of the parameterized geared motor
"paramodul-sn"	String	Number on the SD card (generated upon first use and acts as identification)
"encoder-type"	Number	Type of connected encoder (0: none, 1: incremental, 2: SSI, 3: EnDat, 4: HIPERFACE, 5: Resolver)
"gearmotor-type"	String	Geared motor type
"drive-controller-type"	String	Drive controller type
"reference"	String	Reference of the drive controller
"user"	String	Person who created the project configuration
"motor-type"	String	Motor type
"axis-number"	Number	Axis number (0/1)
"operating-time-h"	Number	Hour value of the operating time
"operating-time-m"	Number	Minute value of the operating time
"operating-time-s"	Number	Seconds value of the operating time
"operating-time"	Number	Operating hours
"motor-serial-number"	Number	Serial number of the motor
"gearbox-serial-number"	Number	Serial number of the gear unit
"encoder-serial-number"	Number	Encoder serial number
"drive-production-number"	Number	Production number of the drive controller according to nameplate (S/N)
"t-reference"	Number	Reference torque for "t-average" and "t-limits"
"t-reference-unit"	String	Unit of reference torque for "t-average" and "t-limits"
"t-limits"	Array of numbers	Load matrix: upper limits of the torque classes
"t-limit-unit"	String	Load matrix: unit of the upper limits of the torque classes
"n-limits"	Array of numbers	Load matrix: upper limits of the speed classes
"n-limit-unit"	String	Load matrix: unit of the upper limits of the speed classes
"t-average"	Array of numbers	Load matrix: mean value of the class limits of the torque classes
"t-average-unit"	String	Load matrix: unit of the mean value of the class limits of the speed classes
"n-average"	Array of numbers	Load matrix: mean value of the class limits of the speed classes
"n-average-unit"	String	Load matrix: unit of the mean value of the class limits of the torque classes
"t-bucket-count"	Number	Load matrix: number of torque classes
"n-bucket-count"	Number	Load matrix: number of speed classes
"time-resolution"	String	Load matrix: resolution
"life-work-indicator"	Number	Value of the life performance indicator
"load-matrix"	Array of numbers	Two-dimensional array containing the load matrix; torque is applied to the rows and speed to the columns

Tab. 290: Information on the load matrix

The following characters or control characters are not allowed in the values of the load matrix:

Symbol	Description
"	Quotation marks
\	Backslash
\b	Backspace
\f	Form feed
\n	Line feed
\r	Carriage return
\t	Horizontal tab character

Tab. 291: Load matrix: impermissible characters or control characters

### 18.7.1.2 Example of a load matrix in JSON format

The following example shows a load matrix in JSON format.

```
{
  "version": "1.0",
  "id": "LoadMatrix",
  "mcgm-database-id": 3156,
  "paramodul-sn": "3522274995",
  "gearmotor-type": "ZR330SPH531SFSS0050EZ505U",
  "encoder-type": 3,
  "drive-controller-type": "SD6A36",
  "reference": "T1",
  "user": "gerhardt.gearhead",
  "motor-type": "ED212U",
  "axis-number": 0,
  "operating-time-h": 2974,
  "operating-time-m": 1,
  "operating-time-s": 41,
  "operating-time": 11706624,
  "motor-serial-number": 183989938,
  "gearbox-serial-number": 183989938,
  "encoder-serial-number": 40925454,
  "drive-production-number": 7000561,
  "t-reference": 120.12345,
  "t-reference-unit": "Nm",
  "t-limits":
  [-2.416667, -2.250000, -2.083333, -1.916667, -1.750000, -1.583333, -1.416667, -1.250000, -1.083333, -0.916667, -0.750000, -0.583333, -0.416667, -0.250000, -0.083333, 0.083333, 0.250000, 0.416667, 0.583333, 0.750000, 0.916667, 1.083333, 1.250000, 1.416667, 1.583333, 1.750000, 1.916667, 2.083333, 2.250000, 2.416667, 2.583333],
  "t-limit-unit": "%",
  "n-limits":
  [-4275.000000, -3825.000000, -3375.000000, -2925.000000, -2475.000000, -2025.000000, -1575.000000, -1125.000000, -675.000000, -225.000000, 225.000000, 675.000000, 1125.000000, 1575.000000, 2025.000000, 2475.000000, 2925.000000, 3375.000000, 3825.000000, 4275.000000, 4725.000000],
  "n-limit-unit": "rpm",
  "t-average":
  [-2.500000, -2.333333, -2.166667, -2.000000, -1.833333, -1.666667, -1.500000, -1.333333, -1.166667, -1.000000, -0.833333, -0.666667, -0.500000, -0.333333, -0.166667, -0.000000, 0.166667, 0.333333, 0.500000, 0.666667, 0.833333, 1.000000, 1.166667, 1.333333, 1.500000, 1.666667, 1.833333, 2.000000, 2.166667, 2.333333, 2.500000],
  "t-average-unit": "%",
  "n-average":
  [-900.000000, -810.000000, -720.000000, -630.000000, -540.000000, -450.000000, -360.000000, -270.000000, -180.000000, -90.000000, 0.000000, 90.000000, 180.000000, 270.000000, 360.000000, 450.000000, 540.000000, 630.000000, 720.000000, 810.000000, 900.000000],
  "n-average-unit": "rpm",
  "t-bucket-count": 31,
}
```

```
"n-bucket-count":21,  
"time-resolution":"1us",  
"life-work-indicator":0.000280,  
"load-matrix":  
[  
[0, 0, 0, 0, 0, 0, 0, 0, 0, 0, 0, 0, 0, 0, 0, 0, 0, 0, 0, 0, ],  
[0, 0, 0, 0, 0, 0, 0, 0, 0, 0, 0, 0, 0, 0, 0, 0, 0, 0, 0, 0, ],  
[0, 0, 0, 0, 0, 0, 0, 0, 0, 0, 0, 0, 0, 0, 0, 0, 0, 0, 0, 0, ],  
[0, 0, 0, 0, 0, 0, 0, 0, 0, 0, 0, 0, 0, 0, 0, 0, 0, 0, 0, 0, ],  
[0, 0, 0, 0, 0, 0, 0, 0, 0, 0, 0, 0, 0, 0, 0, 0, 0, 0, 0, 0, ],  
[0, 0, 0, 0, 1000, 3000, 4000, 4000, 3000, 4000, 1000, 0, 0, 0, 0, 0, 0, 0, 0, 0, 0, ],  
0, ],  
[0, 0, 0, 0, 0, 0, 0, 0, 0, 0, 0, 0, 0, 0, 0, 0, 0, 0, 0, 0, ],  
[0, 0, 0, 0, 0, 0, 0, 0, 0, 0, 2000, 4000, 4000, 3000, 4000, 3000, 0, 0, 0, 0, 0, ],  
0, ],  
[0, 0, 0, 0, 0, 0, 0, 0, 0, 0, 0, 0, 0, 0, 0, 0, 0, 0, 0, 0, ],  
[0, 0, 0, 0, 0, 0, 0, 0, 0, 0, 0, 0, 0, 0, 0, 0, 0, 0, 0, 0, ],  
[0, 0, 0, 0, 0, 0, 0, 0, 0, 0, 0, 0, 0, 0, 0, 0, 0, 0, 0, 0, ],  
[0, 0, 0, 0, 0, 0, 0, 0, 0, 0, 0, 0, 0, 0, 0, 0, 0, 0, 0, 0, ],  
[0, 0, 0, 0, 0, 0, 0, 0, 0, 0, 0, 0, 0, 0, 0, 0, 0, 0, 0, 0, ],  
[0, 0, 0, 0, 20000, 0, 0, 0, 0, 0, 0, 0, 0, 0, 0, 0, 0, 0, 0, 0, 0, ],  
[0, 0, 0, 0, 0, 0, 0, 0, 0, 0, 41000, 0, 0, 0, 0, 0, 0, 0, 0, 0, 0, ],  
[0, 0, 0, 0, 0, 0, 0, 0, 0, 0, 0, 0, 0, 0, 20000, 0, 0, 0, 0, 0, 0, ],  
[0, 0, 0, 0, 0, 0, 0, 0, 0, 0, 0, 0, 0, 0, 0, 0, 0, 0, 0, 0, ],  
[0, 0, 0, 0, 0, 0, 0, 0, 0, 0, 0, 0, 0, 0, 0, 0, 0, 0, 0, 0, ],  
[0, 0, 0, 0, 0, 0, 0, 0, 0, 0, 0, 0, 0, 0, 0, 0, 0, 0, 0, 0, ],  
[0, 0, 0, 0, 0, 0, 0, 0, 0, 0, 0, 0, 0, 0, 0, 0, 0, 0, 0, 0, ],  
[0, 0, 0, 0, 0, 0, 0, 0, 0, 0, 0, 0, 0, 0, 0, 0, 0, 0, 0, 0, ],  
[0, 0, 0, 0, 0, 3000, 4000, 4000, 3000, 4000, 2000, 0, 0, 0, 0, 0, 0, 0, 0, 0, 0, ],  
0, ],  
[0, 0, 0, 0, 0, 0, 0, 0, 0, 0, 0, 0, 0, 0, 0, 0, 0, 0, 0, 0, ],  
[0, 0, 0, 0, 0, 0, 0, 0, 0, 0, 1000, 4000, 4000, 3000, 4000, 3000, 1000, 0, 0, 0, 0, ],  
0, ],  
[0, 0, 0, 0, 0, 0, 0, 0, 0, 0, 0, 0, 0, 0, 0, 0, 0, 0, 0, 0, ],  
[0, 0, 0, 0, 0, 0, 0, 0, 0, 0, 0, 0, 0, 0, 0, 0, 0, 0, 0, 0, ],  
[0, 0, 0, 0, 0, 0, 0, 0, 0, 0, 0, 0, 0, 0, 0, 0, 0, 0, 0, 0, ],  
[0, 0, 0, 0, 0, 0, 0, 0, 0, 0, 0, 0, 0, 0, 0, 0, 0, 0, 0, 0, ],  
[0, 0, 0, 0, 0, 0, 0, 0, 0, 0, 0, 0, 0, 0, 0, 0, 0, 0, 0, 0, ],  
]  
}
```

### 18.7.2 Life performance indicator

The life performance indicator is the value for the calculated life performance of the geared motor. No additional external sensor is required to determine it. In DriveControlSuite, the life performance indicator is displayed in the Predictive Maintenance wizard (R101). Values below 100% mean that the geared motor is being operated within its life performance. For values above 100%, the probability of failure increases. From a value of 90%, it is recommended to replace the geared motor and a corresponding message is output in parameter R100.

**Information**

Increasing values do not mean that there is damage to the geared motor. Operation of the geared motor is also possible at values > 100%.

**Information**

The life performance indicator is calculated and updated only if the axis is enabled (A900 = 1).

The life performance indicator is stored in non-volatile memory in the drive controller every 10 minutes, and on the Paramodul together with the load matrix every 30 minutes. The A00 Save values action does not influence the calculation and updating of the life performance indicator.

The life performance indicator increases monotonically: faster with greater load, slower with lesser load.

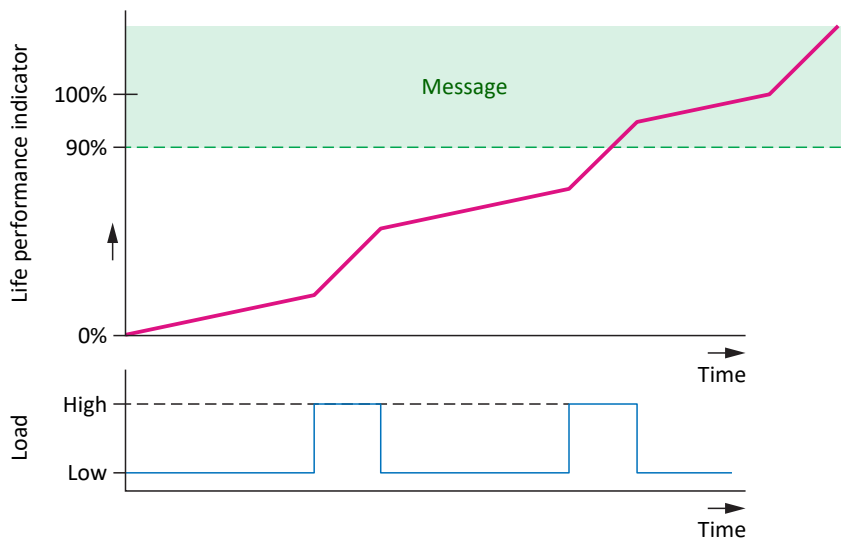

Fig. 81: Signaling area

The algorithm for the life performance indicator is continuously being developed by STOBER.

### 18.7.3 Recommendation for geared motor replacement

The recommendation to replace the geared motor is displayed in DriveControlSuite in the Predictive Maintenance wizard (R100). The recommendation is triggered when STOBER Predictive Maintenance is active and the life performance indicator reaches a value  $\geq 90\%$  (R101).



### 18.7.4 Reading out and transmitting the load matrix

Would you like to know more about the real-world load situation of your machine and its optimization potential? Would you like to support the further development of our algorithm? If you send us your load matrix, we will help you in analyzing or visualizing your data. We will also be able to take your specific machine behavior into consideration for further development.

**Information**

It is not possible to infer specific machine cycles based on the load matrix. The load matrix contains only highly condensed, statistical features.

**Reading out data**

The following graphic describes the 3 options for reading out the data.

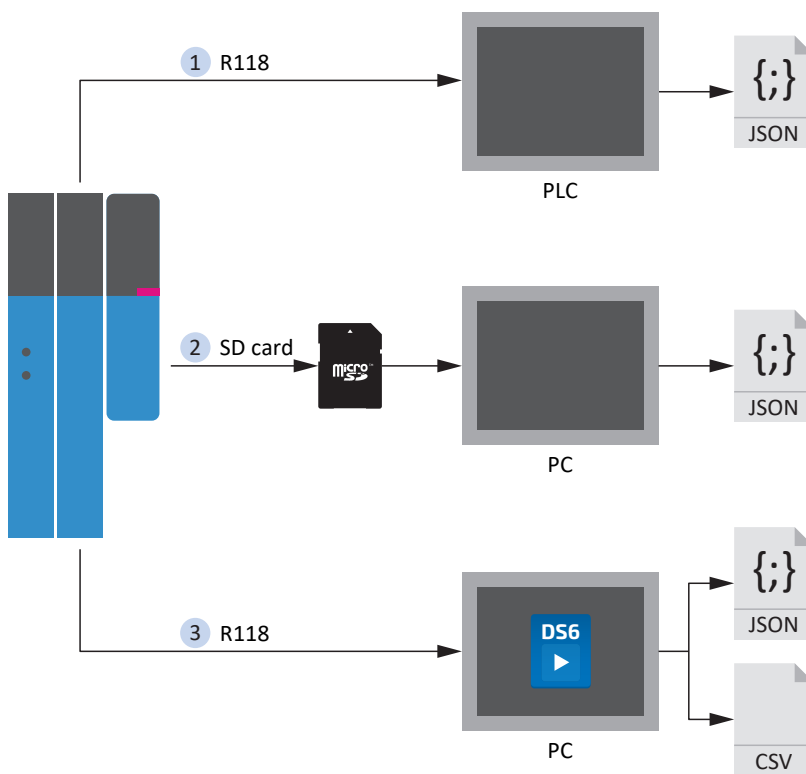

Fig. 82: Predictive Maintenance: Options for readout

**1. Via the controller (in preparation)**

STOBER provides a function block for controllers in accordance with IEC 61131-3. The function block enables the controller to read out parameter R118 and write it to a JSON file.

## 2. From the SD card

You can read out the data on your PC directly from the SD card.

The JSON files are stored in the following form:

- If a serial number is available for the motor, it is used for the file name
- If no serial number is available for the motor, the file name consists of 8 characters (hexadecimal)

File name	Example
PRM\[Serial number].PXX	03774434.P00
PRM\[8 characters].PXX	0BB5A846.P00

Tab. 292: Predictive Maintenance files on SD card

To avoid data loss, the files are each stored twice on the SD card.

The file extensions have the following meaning:

File extension	Meaning
P00	JSON for axis 1
P01	JSON for axis 1 (backup)
P10	JSON for axis 2
P11	JSON for axis 2 (backup)

Tab. 293: Meaning of file extensions on SD card

## 3. Via DriveControlSuite

Use the associated wizard in DriveControlSuite to export the load matrix. For the export, parameter R118 is read out from the drive controller (if an online connection exists) or from your project (in offline mode).

### Transmitting the data

You can provide the data to STOBER via upload through DriveControlSuite or by email to [prm\\_data@stober.de](mailto:prm_data@stober.de).

## 19 Diagnostics

LEDs on the top and front give you initial information about the device state of the respective device as well as the states of the physical connection and the communication. In the event of an error or fault, you will receive detailed information through the DriveControlSuite commissioning software.

### 19.1 Drive controllers

STOBER drive controllers have diagnostic LEDs that visually indicate the state of the drive controller as well as the states of the physical connection and communication.

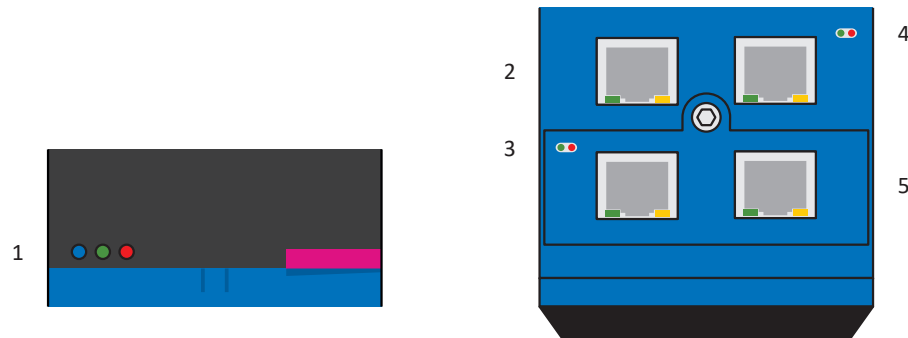

Fig. 83: Positions of the diagnostic LEDs on the front and top of the drive controller

- 1 Drive controller state
- 2 Service network connection
- 3 Fieldbus state
- 4 IGB state
- 5 Fieldbus network connection

### 19.1.1 Drive controller state: LEDs

3 LEDs on the front of the device provide information about the state of the drive controller.

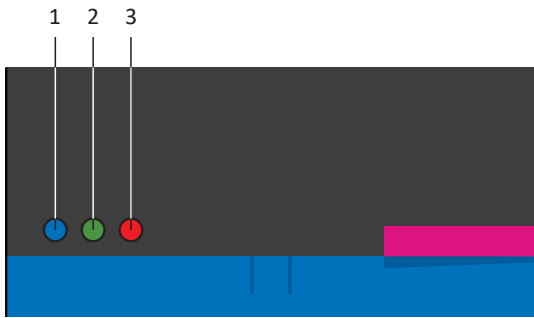

Fig. 84: LEDs for the state of the drive controller on the front of the SD6

- 1 Blue: REMOTE
- 2 Green: RUN
- 3 Red: ERROR

Blue LED	Conduct	Description
	Off	Remote maintenance not active
	Single blink	Connection established to the teleserver
	Flashing	Drive controller waits for connection to DriveControlSuite
	On	Remote maintenance is active

Tab. 294: Meaning of the blue LED (REMOTE)

LEDs: Green/Red	Conduct	Description
	Off	No supply voltage
	Off	
	Single blink	STO active
	Off	
	Flashing	Ready to switch on
	Off	
	On	Operation enabled
	Off	
	Rapid flashing	Data is written to internal memory and the SD card
	Off	
	On	Warning in the 4: Enabled device state
	Flashing	
	Flashing	Warning in the 2: Ready for switch-on device state
	Flashing	
	Off	Faults
	On	
	Off	No configuration active
	Rapid flashing	

Tab. 295: Meaning of the green and red LED (RUN)

## 19.1.2 Drive controller state: Display

Event displays on the display give you additional information about the state of the drive controller.

For a listing of all events with descriptions, see [Events \[▶ 327\]](#).

### Display of the reaction

If the event is parameterized as **Message**, it appears flashing in the lower display. An application is not affected by a message; that is, the operation continues. A message is not acknowledged, but remains pending until the cause disappears.

A **Warning** is displayed by the corresponding, flashing words. In addition, the display shows the event and time remaining until the cause is remedied. If the cause disappears within this time, the warning is reset. An application is not affected by a warning. If the cause is not remedied, the warning becomes a fault after the defined time expires.

If an event occurs with the **Fault** level, this is indicated by the corresponding, flashing words. The drive controller immediately changes to the fault reaction device state. The event is shown on the display. A fault must be acknowledged. For many events, the drive controller provides information about the cause. This is additionally output on the display and is indicated by a number:



Fig. 85: Appearance of a fault on the display

Causes that are not documented in the event descriptions with a number are not shown on the display. In this case, the documentation only provides information about potential errors.

### Events during active configuration

Once the device start-up is completed and the configuration is active, the events identified by a number monitor the operation. For some of these events, acknowledgement is possible on the operating unit or can be programmed via digital input. Communication and operation of the drive controller are not affected. For further diagnostics, the occurrence of an event is noted by a counter. You can find the Fault counter in parameter group Z. Some of these events can be parameterized, e.g. Event 39: Overtemperature drive controller i2t.

### Error when the drive controller is started

When the drive controller is started, the configuration from the Paramodul is loaded. Then the configuration is started. During both steps, detailed error messages can be generated that can be output on the display and indicated by an \*. You can find more information about the cause and the required measures in the corresponding event descriptions.

### 19.1.2.1 \*NoConfiguration

Error when the drive controller is started:

- The power unit remains switched off
- The brakes remain engaged

The brake chopper remains switched off.

#### ParaModul Error

Cause		Check and action
1:Read Error	Control unit was switched off while saving (A00)	Transfer the configuration of the drive controller from a project file using DS6 to the drive controller and save the configuration in Paramodul (A00); fault cannot be acknowledged
	Empty or disconnected Paramodul	
	Defective or unformatted Paramodul	Replace the Paramodul; fault cannot be acknowledged
3:Update Firmware!	The configuration in Paramodul cannot be executed with the current firmware because it uses unknown configuration memory areas	Update the firmware; fault cannot be acknowledged

Tab. 296: \*NoConfiguration, Cause: ParaModul Error – Causes and actions

#### ConfigStartError

Cause		Check and action
1:Parameters lost	Control unit was switched off while saving (A00)	Transfer the configuration of the drive controller from a project file using DS6 to the drive controller and save the configuration in Paramodul (A00); fault cannot be acknowledged
4:Non-volatile lost	Save (A00) was not carried out	
5:Unknown Block	The configuration saved in Paramodul comes from a newer firmware that knows more system blocks	Update the firmware; fault cannot be acknowledged
6:Unknown String	The configuration saved in Paramodul comes from newer firmware that knows more texts (e.g. names of the system default block parameters)	
7:Unknown Scale	The configuration saved in Paramodul comes from newer firmware that knows more scaling functions	

Cause		Check and action
8: Unknown Limit	The configuration saved in Paramodul comes from newer firmware that knows more limit value functions	
9:Unknown Post-Wr	The configuration saved in Paramodul comes from newer firmware that knows more post-write functions	
10:Unknown Pre-Read	The configuration saved in Paramodul comes from newer firmware that knows more pre-read functions (mapping of firmware parameters to configuration parameters)	
11:Unknown Hiding	The configuration saved in Paramodul comes from newer firmware that knows more hiding functions (hiding of parameters that should be visible depending on other parameters)	
12:Unknown Post-Read	The configuration saved in Paramodul comes from newer firmware that knows more post-read functions	
13:Unknown Pre-Write	The configuration saved in Paramodul comes from newer firmware that knows more pre-write functions (mapping of firmware parameters to configuration parameters)	

Tab. 297: \*NoConfiguration, Cause: ConfigStartError – Causes and actions

**Configuration Stopped**

Cause	Check and action
Transfer of the configuration through DS6 was interrupted	Switch the drive controller off and back on to load the previous configuration from Paramodul; fault cannot be acknowledged
	Transfer the configuration of the drive controller from a project file using DS6 to the drive controller and save the configuration in Paramodul (A00); fault cannot be acknowledged

Tab. 298: \*NoConfiguration, Cause: Configuration Stopped – Causes and actions

### 19.1.3 Service network connection

The LEDs at X3A and X3B on the top of the device indicate the state of the service network connection.

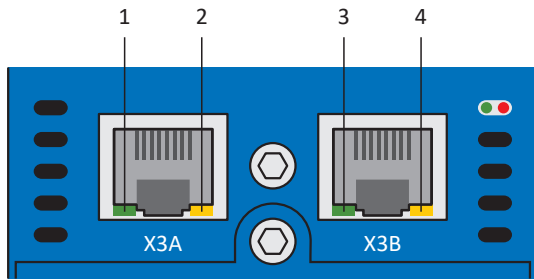

Fig. 86: LEDS for the state of the service network connection on the top of the SD6

- 1 LINK at X3A
- 2 ACTIVITY at X3A
- 3 LINK at X3B
- 4 ACTIVITY at X3B

Green LED	Conduct	Description
	Off	Physical connection not available
	On	Physical connection to the network is available and link is set up

Tab. 299: Meaning of the green LED (LINK)

Yellow LED	Conduct	Description
	Off	Physical connection not available
	Flashing	Individual data packets are sent or received
	On	Continuous data communication

Tab. 300: Meaning of the yellow LED (ACTIVITY)



### 19.1.4 Fieldbus state

The LEDs for the diagnostics of the fieldbus state vary depending on the implemented fieldbus system or communication module.

#### 19.1.4.1 EtherCAT state

There are 2 LEDs on the top of the drive controller that provide information about the connection between EtherCAT master and slave and about the state of the data exchange. This information can also be read out in parameter A255.

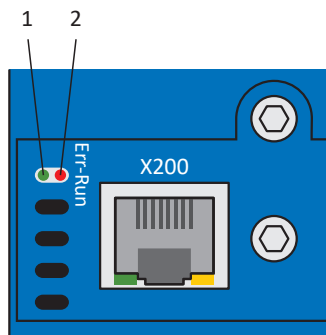

Fig. 87: LEDs for the EtherCAT state

- 1 Green: Run
- 2 Red: Error

Green LED	Conduct	Operating state	Description
	Off	Init	No communication between the EtherCAT master and slave; the configuration starts, saved values are loaded
	Flashing	Pre-operational	No PDO communication; the EtherCAT master and slave exchange application-specific parameters via SDOs
	1x flash	Safe-operational	The EtherCAT slave sends the current actual values to the EtherCAT master, ignores its set values and refers to internal default values
	On	Operational	Normal operation: The EtherCAT master and slave exchange set and actual values

Tab. 301: Meaning of the green LED (Run)

Red LED	Conduct	Error	Description
	Off	No Error	No error
	Flashing	Invalid Configuration	Invalid configuration
	Single flash	Unsolicited State Change	The EtherCAT slave changed operating states by itself
	2x flash	Application Watchdog Timeout	The EtherCAT slave did not receive new PDO data during the configured watchdog timeout

Tab. 302: Meaning of the red LED (error)

### 19.1.4.2 PROFINET state

There are 2 LEDs on the front of the drive controller that provide information about the connection between the controller and drive controller and about the state of the data exchange. This information can also be read out in parameter A271 PN state.

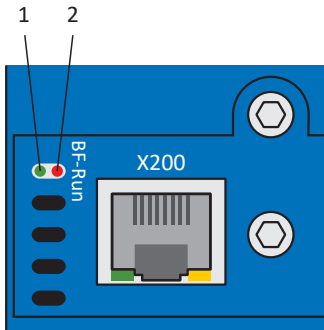

Fig. 88: LEDs for the PROFINET state

- 1 Red: BF (bus error)
- 2 Green: Run

Red LED	Conduct	Description
	Off	No error
	Rapid flashing	Data exchange with controller not active
	On	No network connection

Tab. 303: Meaning of the red LED (BF)

Green LED	Conduct	Description
	Off	No connection
	Single blink	Connection is set up to controller
	Single blink, inverse	Controller activates DHCP signal service
	Flashing	Existing connection to controller; data exchange expected
	On	Existing connection to controller

Tab. 304: Meaning of the green LED (Run)

### 19.1.4.3 CANopen state

There are 2 LEDs on the top of the drive controller that provide information about the connection between the CANopen master and slave and about the state of the data exchange. This information can also be read out in parameter A245.

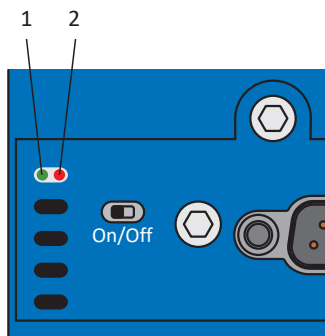

Fig. 89: LEDs for the CAN status

- 1 Green: Run
- 2 Red: Error

Green LED	Conduct	NMT state	Description
	Off	Init	No error, no warning
	Flashing	Pre-operational	The drive controller is ready for parameterization to prepare for actual operation.
	1x flash	Stopped	All communication activities have stopped.
	On	Operational	The CAN bus is activated, all services are in operation.

Tab. 305: Meaning of the green LED (Run)

Red LED	Conduct	Error	Description
	Off	No error, no warning	No error
	1x flash	Communication error in the operational state (Warning level)	Check the bus cables, shielding and compliance with the CAN specifications regarding this.
	2x flash	Node guard event	Check the node guard function of the controller.
	3x flash	SYNC error	Check the SYNC configuration of the controller.
	On	Bus off	The SD6 in question is no longer participating in the CAN communication. Check the baud rate and bus cables and switch the drive controller off and on again.

Tab. 306: Meaning of the red LED (error)

### 19.1.5 IGB state

2 LEDs on the top of the device indicate the IGB state.

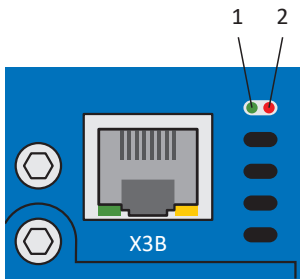

Fig. 90: LEDs for the IGB state on the top of the device

- 1 Green: RUN
- 2 Red: ERROR

Green LED	Conduct	Description
	Off	IGB is not active
	Flashing	The IGB state is 2: IGB running
	On	The IGB state is 3: IGB-motionbus

Tab. 307: Meaning of the green LED (RUN)

Red LED	Conduct	Description
	Off	IGB Motion Bus is not used or works correctly
	On	The IGB state is 4: IGB-Motionbus Error

Tab. 308: Meaning of the red LED (ERROR)

## 19.1.6 Fieldbus network connection

The LEDs for communication diagnostics vary depending on implemented fieldbus system or communication module.

### 19.1.6.1 EtherCAT network connection

The LEDs LA<sub>ec</sub>IN and LA<sub>ec</sub>OUT at X200 and X201 on the top of the device display the state of the network connection.

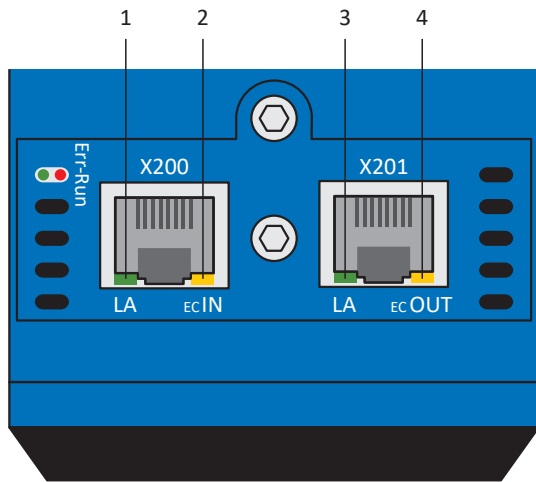

Fig. 91: LEDs for the state of the EtherCAT network connection

- 1 Green: LA<sub>ec</sub>IN at X200
- 2 Yellow: No function
- 3 Green: LA<sub>ec</sub>OUT at X201
- 4 Yellow: No function

Green LED	Behavior	Description
	Off	No network connection
	Flashing	Active data exchange with other EtherCAT nodes
	On	Network connection exists

Tab. 309: Meaning of the green LEDs (LA)

### 19.1.6.2 PROFINET network connection

The Act. and Link LEDs at X200 and X201 on the top of the device indicate the state of the PROFINET network connection.

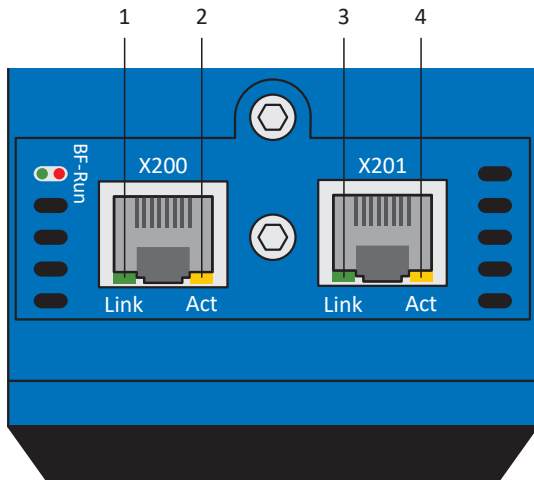

Fig. 92: LEDs for the state of the PROFINET network connection

- 1 Green: Link at X201
- 2 Yellow: Activity at X201
- 3 Green: Link at X200
- 4 Yellow: Activity at X200

Green LED	Behavior	Description
	Off	No network connection
	On	Network connection exists

Tab. 310: Meaning of the green LEDs (Link)

Yellow LED	Behavior	Description
	Off	No data exchange
	Flashing	Active data exchange with IO controller

Tab. 311: Meaning of the yellow LEDs (Act.)

## 19.1.7 Events

The drive controller has a self-monitoring system that uses test rules to protect the drive system from damage. Violating the test rules triggers a corresponding event. There is no possible way for you as the user to intervene in some events, such as the Short/ground event. In others, you can influence the effects and responses.

Possible effects include:

- **Message:** Information that can be evaluated by the controller
- **Warning:** Information that can be evaluated by the controller and becomes a fault after a defined time span has elapsed without the cause being resolved
- **Fault:** Immediate drive controller response; the power unit is disabled and axis movement is no longer controlled by the drive controller or the axis is brought to a standstill by a quick stop or emergency braking

### ATTENTION!

#### Damage to property due to interruption of a quick stop or emergency braking!

If, when executing a quick stop or emergency braking, a fault occurs or STO is active, the quick stop or emergency braking is interrupted. In this case, the machine can be damaged by the uncontrolled axis movement.

Events, their causes and suitable measures are listed below. If the cause of the error is corrected, you can usually acknowledge the error immediately. If the drive controller has to be restarted instead, a corresponding note can be found in the measures.

### Information

To make it easier for control programmers to set up the human-machine interface (HMI), a list of events and their causes can be found in the STOBER download center at <http://www.stoeber.de/en/downloads/>.

### 19.1.7.1 Overview

The following table shows the possible events at a glance.

Event
<a href="#">Event 31: Short/ground [▶ 329]</a>
<a href="#">Event 32: Short/ground internal [▶ 329]</a>
<a href="#">Event 33: Overcurrent [▶ 330]</a>
<a href="#">Event 34: Hardware fault [▶ 331]</a>
<a href="#">Event 35: Watchdog [▶ 332]</a>
<a href="#">Event 36: High voltage [▶ 332]</a>
<a href="#">Event 37: Motor encoder [▶ 333]</a>
<a href="#">Event 38: Temperature drive controller sensor [▶ 336]</a>
<a href="#">Event 39: Overtemperature drive controller i2t [▶ 337]</a>
<a href="#">Event 40: Invalid data [▶ 338]</a>
<a href="#">Event 41: Temp.MotorTMP [▶ 339]</a>
<a href="#">Event 42: TempBrakeRes [▶ 340]</a>
<a href="#">Event 43: AI1 wire break [▶ 341]</a>
<a href="#">Event 44: External fault 1 [▶ 342]</a>
<a href="#">Event 45: Overtemp.motor i2t [▶ 343]</a>

Event
<a href="#">Event 46: Low voltage [▶ 344]</a>
<a href="#">Event 47: Torque/force-max. limit [▶ 345]</a>
<a href="#">Event 48: Brake release monitoring [▶ 346]</a>
<a href="#">Event 49: Brake [▶ 347]</a>
<a href="#">Event 50: Safety module [▶ 348]</a>
<a href="#">Event 51: Virtual master software limit switch [▶ 349]</a>
<a href="#">Event 52: Communication [▶ 350]</a>
<a href="#">Event 53: Limit switch [▶ 351]</a>
<a href="#">Event 54: Following error [▶ 352]</a>
<a href="#">Event 55: Option module [▶ 353]</a>
<a href="#">Event 56: Overspeed [▶ 354]</a>
<a href="#">Event 57: Runtime requirement [▶ 355]</a>
<a href="#">Event 58: Encoder simulation [▶ 356]</a>
<a href="#">Event 59: Overtemperature drive controller i2t [▶ 357]</a>
<a href="#">Event 60: Application event 0 – Event 67: Application event 7 [▶ 358]</a>
<a href="#">Event 68: External fault 2 [▶ 359]</a>
<a href="#">Event 69: Motor connection [▶ 360]</a>
<a href="#">Event 70: Parameter consistency [▶ 361]</a>
<a href="#">Event 71: Firmware [▶ 362]</a>
<a href="#">Event 72: Brake test timeout – Event 75: Axis 4 brake test timeout [▶ 363]</a>
<a href="#">Event 76: Position encoder [▶ 364]</a>
<a href="#">Event 77: Master encoder [▶ 367]</a>
<a href="#">Event 78: Position limit cyclic [▶ 369]</a>
<a href="#">Event 79: Motor/position encoder plausibility [▶ 370]</a>
<a href="#">Event 80: Illegal action [▶ 371]</a>
<a href="#">Event 81: Motor allocation [▶ 372]</a>
<a href="#">Event 82: Hall sensor [▶ 373]</a>
<a href="#">Event 83: Failure of one/ all phases (mains) [▶ 374]</a>
<a href="#">Event 84: Drop in network voltage when power section active [▶ 375]</a>
<a href="#">Event 85: Excessive jump in reference value [▶ 376]</a>
<a href="#">Event 88: Control panel [▶ 377]</a>
<a href="#">Event 90: Motion block [▶ 378]</a>

Tab. 312: Events



### 19.1.7.2 Event 31: Short/ground

The drive controller is interrupted:

- The power unit is disabled and axis movement is no longer controlled by the drive controller
- The behavior of the brakes depends on the configuration of the safety module and an optional release override (F06)

The brake chopper is switched off.

**ATTENTION!**

**Material damage due to repeated activation and deactivation or new enable signal!**

Repeated activation and deactivation or a new enable signal with an existing short circuit can lead to a device fault.

- Before the new activation or enable signal, the cause must be found and corrected.

Cause	Check and action
Connection error at the motor	Check the connection and correct it if necessary
Defective power cable	Check the cable and replace it if necessary
Short-circuit in the motor winding	Check the motor and replace it if necessary
Short-circuit in the braking resistor	Check the braking resistor and replace it if necessary
Short-circuit/ground fault inside the device	Check whether the fault occurs when switching on the power unit and replace the drive controller if necessary; the fault can only be acknowledged after 30 s

Tab. 313: Event 31 – Causes and actions

### 19.1.7.3 Event 32: Short/ground internal

The drive controller is interrupted:

- The power unit is disabled and axis movement is no longer controlled by the drive controller
- The behavior of the brakes depends on the configuration of the safety module and an optional release override (F06)

The brake chopper is switched off.

**ATTENTION!**

**Material damage due to repeated activation and deactivation!**

Repeated activation and deactivation with an existing short circuit can lead to a device fault.

- Before the new activation or enable signal, the cause must be found and corrected.

Cause	Check and action
Short-circuit/ground fault inside the device	Replace the drive controller; the fault cannot be acknowledged

Tab. 314: Event 32 – Causes and actions

### 19.1.7.4 Event 33: Overcurrent

The drive controller is interrupted if:

- U30 = 0: Inactive

Response:

- The power unit is disabled and axis movement is no longer controlled by the drive controller
- The brakes are applied in the event of an inactive release override (F06)

The drive controller is interrupted with emergency braking if:

- U30 = 1: Active and
- A29 = 1: Active for Drive Based device controller  
or
- U30 = 1: Active and
- A540 = 2: Slow down on quick stop ramp for CiA 402 device controller

Response:

- The axis is stopped by emergency braking; the brakes are applied in the event of an inactive release override (F06)
- At the end of emergency braking, the power unit is disabled and axis movement is no longer controlled by the drive controller

Emergency braking is only possible for the synchronous servo, torque and synchronous linear motor types.

Cause	Check and action
Short acceleration times	Check the actual current using the scope image and reduce the acceleration values if necessary (E00); the fault can only be acknowledged 3 s after the cause has been corrected
Large torque/force limits	Check the actual current using the scope image (E00) and reduce the torque/force limits if necessary (C03, C05); the fault can only be acknowledged 3 s after the cause has been corrected
Wrong drive controller design	Check the design and change the drive controller type if necessary; the fault can only be acknowledged 3 s after the cause has been corrected

Tab. 315: Event 33 – Causes and actions

### 19.1.7.5 Event 34: Hardware fault

The drive controller is interrupted:

- The power unit is disabled and axis movement is no longer controlled by the drive controller
- The behavior of the brakes depends on the configuration of the safety module and an optional release override (F06)

Cause		Check and action
1: FPGA, 2: NOV control unit, 3: NOV-Power Unit, 6: NOV safety module, 7: Current measurement, 8: power supply, 9: power supply, 10: power supply, 11: power supply, 12: Timer control board	Defective drive controller	Exchange drive controller; fault cannot be acknowledged
13: Communication module adress-/databus, 14: Communication module signal lines, 15: Communication module clock error, 16: Communication module voltage missing, 17: Communication module databus	Defective or incorrectly installed communication module or defective drive controller	Removal and installation of the communication module; replace the communication module or drive controller if necessary; fault cannot be acknowledged
18: Terminal module adress-/ databus, 19: Terminal module signal lines, 20: Terminal module clock error, 21: Terminal module voltage is missing, 22: Terminal module databus	Defective or incorrectly installed terminal module or defective drive controller	Removal and installation of the terminal module; replace the terminal module or drive controller if necessary; fault cannot be acknowledged
23: FPGA, 24: FPGA, 25: FPGA, 26: CPU, 27: CPU, 28: CPU, 29: Communication	Defective drive controller	Exchange drive controller; fault cannot be acknowledged
30: power supply	Defective drive controller Defective encoder Power output of encoder interface outside specification	Check encoder power consumption; replace defective or incorrectly selected component; fault cannot be acknowledged

Tab. 316: Event 34 – Causes and actions

### 19.1.7.6 Event 35: Watchdog

The drive controller is interrupted:

- The power unit is disabled and axis movement is no longer controlled by the drive controller
- The behavior of the brakes depends on the configuration of the safety module and an optional release override (F06)

The brake chopper and brake release override are non-functional while the runtime system restarts.

Cause		Check and action
1: Core 0, 2: Core 1	Microprocessor at full load	Check the runtime utilization using the scope image (E191) and reduce it using a longer cycle time if necessary (A150)
	Microprocessor faulty	Check the connection and shielding and correct them if necessary; replace the drive controller if necessary

Tab. 317: Event 35 – Causes and actions

### 19.1.7.7 Event 36: High voltage

The drive controller is interrupted:

- The power unit is disabled and axis movement is no longer controlled by the drive controller
- The behavior of the brakes depends on the configuration of the safety module and an optional release override (F06)

Cause	Check and action
Short delay times	Check the DC link voltage during the braking operation using the scope image (E03) and, if necessary, reduce the delay values, use a (larger) braking resistor or connect a DC link
Brake chopper deactivated	Check the values of the parameterized braking resistor and correct it if necessary (A21, A22, A23)
Braking resistor connection error	Check the connection to the braking resistor and drive controller and correct them if necessary
Pulse power of the braking resistor is too low	Check that the braking resistor pulse power is suitable for the application; replace the braking resistor if necessary
Brake chopper is defective	Check the DC link voltage during the braking operation using the scope image (E03); the brake chopper is defective if the DC link voltage exceeds the on limit of the brake chopper (R31) without the DC link voltage dropping; replace the drive controller if necessary
Supply voltage exceeded	Check the supply voltage for an overrun of the permitted input voltage and adjust it if necessary

Tab. 318: Event 36 – Causes and actions

### 19.1.7.8 Event 37: Motor encoder

The drive controller is interrupted if:

- U30 = 0: Inactive

Response:

- The power unit is disabled and axis movement is no longer controlled by the drive controller
- The brakes are applied in the event of an inactive release override (F06)

The drive controller is interrupted with emergency braking if:

- U30 = 1: Active and
- A29 = 1: Active for Drive Based device controller  
or
- U30 = 1: Active and
- A540 = 2: Slow down on quick stop ramp for CiA 402 device controller

Response:

- The axis is stopped by emergency braking; the brakes are applied in the event of an inactive release override (F06)
- At the end of emergency braking, the power unit is disabled and axis movement is no longer controlled by the drive controller

Emergency braking is only possible for the synchronous servo, torque and synchronous linear motor types.

Cause		Check and action
1: Parameter <-> encoder	Inconsistent parameterization	Compare the specification of the connected encoder to the corresponding values of the H parameters and correct them if necessary
2: X4 maximum speed	Exceeded encoder maximum velocity	Check the actual velocity during a movement using the scope image (I88) and adjust the permitted encoder maximum velocity if necessary (I297)
	Connection error	Check the connection and shielding and correct them if necessary
6: X4 EnDat encoder found	Inconsistent parameterization	Compare the connected encoder to the parameterized encoder and correct it if necessary (H00)
7: X4 channel A/incremental	Connection error	Check the connection and correct it if necessary
8: X4 no encoder found	Connection error	Check the connection and correct it if necessary; restart the drive controller to switch the encoder supply back on
	Defective encoder cable	Check the cable and replace it if necessary; restart the drive controller to switch the encoder supply back on
	Defective power supply	Check the encoder power supply and correct it if necessary; restart the drive controller to switch the encoder supply back on
	Inconsistent parameterization	Compare the connected encoder to the parameterized encoder and correct it if necessary (H00); restart the drive controller to switch encoder supply back on

Cause		Check and action
10: X4 channel A/Clk, 11: X4 channel B/Dat, 12: X4 channel 0	Defective encoder cable	Check the cable and replace it if necessary
13: X4-EnDat alarm	Defective EnDat encoder	Replace the motor; EnDat 2.1 digital, EnDat 2.2 digital: Fault cannot be acknowledged
14: X4 EnDat CRC, 15: X4 double transmission	Connection error	Check the connection and correct it if necessary
	Electromagnetic interference	Take EMC recommendations into account [► 144] and, if necessary, increase the fault tolerance (B298)
16: X4 busy	Defective encoder cable	Check the cable and replace it if necessary
	Inconsistent parameterization	Compare the connected encoder to the parameterized encoder and correct it if necessary (H00)
	Incompatible encoder	Compare the specification of the encoder with the corresponding specifications from STOBER and replace the motor if necessary
17: EBI encoder low battery	Battery in battery module weak	Replace the battery; reference remains intact
18: EBI encoder battery empty	Battery in battery module empty	Replace the battery
	Initial connection	–
	Connection error	Check the connection and correct it if necessary
	Defective encoder cable	Check the cable and replace it if necessary
	Faulty battery module	Check the battery module and replace it if necessary
19: Alarm bit	Encoder fault	Check the specification of the encoder regarding the alarm bit
20: Resolver carrier, 21: Resolver sin/cos undervoltage, 22: Resolver sin/cos overvoltage	Defective encoder cable	Check the cable and replace it if necessary
	Incompatible encoder	Compare the specification of the encoder with the corresponding specifications from STOBER and replace the encoder or motor if necessary; fault cannot be acknowledged
24: Resolver failure	Defective encoder cable	Check the cable and replace it if necessary
30: X120 wire break	Defective encoder cable	Check the cable and replace it if necessary
35: X120 double transmission	Defective encoder cable	Check the cable and replace it if necessary; fault cannot be acknowledged
	Inconsistent double transmission	Check the specification of the connected encoder and deactivate the double transmission (H128) or replace the encoder if necessary
	Incompatible encoder	Compare the specification of the encoder with the corresponding specifications from STOBER and replace the encoder or motor if necessary

Cause		Check and action
36: X120 busy	Defective encoder cable	Check the cable and replace it if necessary
	Inconsistent parameterization	Compare the connected encoder to the parameterized encoder and correct it if necessary (H120)
	Incompatible encoder	Compare the specification of the encoder with the corresponding specifications from STOBER and replace the motor if necessary
43: X140 EnDat alarm	Defective EnDat encoder	Replace the motor
44: X140 EnDat CRC	Connection error	Check the connection and shielding and correct them if necessary
	Electromagnetic interference	<a href="#">Take EMC recommendations into account [► 144]</a> and, if necessary, increase the fault tolerance (B298)

Tab. 319: Event 37 – Causes and actions

### 19.1.7.9 Event 38: Temperature drive controller sensor

The drive controller is interrupted if:

- A29 = 0: Inactive for Drive Based device controller  
or
- A540 = 0: Disable drive motor coasting for CiA 402 device controller

Response:

- The power unit is disabled and axis movement is no longer controlled by the drive controller
- The brakes are applied in the event of an inactive release override (F06)

The drive controller has a fault and a quick stop occurs if:

- A29 = 1: Active for Drive Based device controller  
or
- A540 = 2: Slow down on quick stop ramp for CiA 402 device controller

Response:

- The axis is stopped by a quick stop; meanwhile, the brakes remain released
- At the end of the quick stop, the power unit is disabled and the axis movement is no longer controlled by the drive controller; the brakes engage if release override is inactive (F06)

Cause	Check and action
Surrounding temperatures too high or too low	Check the surrounding temperature of the drive controller and adjust it to the operating conditions of the drive controller if necessary; the fault can only be acknowledged 30 s after the cause has been corrected
Too little air circulation in the control cabinet	Check the minimum clearances and adjust them if necessary; the fault can only be acknowledged 30 s after the cause has been corrected
Defective or blocked fan	Switch on control unit supply; check that the fan starts and replace the drive controller if necessary; the fault can only be acknowledged 30 s after the cause has been corrected
Assembly protection film	Remove the assembly protection film
Wrong drive controller design	Check the design and change the drive controller type if necessary; the fault can only be acknowledged 30 s after the cause has been corrected
Increased or reduced mechanical friction	Check the service status of the mechanical system of all axes and service them if necessary; the fault can only be acknowledged 30 s after the cause has been corrected
Mechanical block	Check the output of all axes and remove the block if necessary
Short deceleration/acceleration times	Check the actual current during the braking process using the scope image (E00); reduce the deceleration and acceleration values if necessary; the fault can only be acknowledged 30 s after the cause has been corrected
Clock frequency too high	Check the utilization of the drive, taking into account derating and the configured clock frequency (E20, B24); reduce the configured clock frequency or replace the drive controller if necessary; the fault can only be acknowledged 30 s after the cause has been corrected

Tab. 320: Event 38 – Causes and actions



### 19.1.7.10 Event 39: Overtemperature drive controller i2t

The possible effects depend on the configured level (U02):

- 0: Inactive
- 1: Message
- 2: Warning
- 3: Fault

The maximum permitted output current is limited to 100% of  $I_{2N,PU}$  (R04). If the  $i^2t$  value (E24) increases to 105%, event 59: Overtemperature drive controller i2t is triggered.

The drive controller is interrupted if:

- A29 = 0: Inactive for Drive Based device controller  
or
- A540 = 0: Disable drive motor coasting for CiA 402 device controller

Response:

- The power unit is disabled and axis movement is no longer controlled by the drive controller
- The brakes are applied in the event of an inactive release override (F06)

The drive controller has a fault and a quick stop occurs if:

- A29 = 1: Active for Drive Based device controller  
or
- A540 = 2: Slow down on quick stop ramp for CiA 402 device controller

Response:

- The axis is stopped by a quick stop; meanwhile, the brakes remain released
- At the end of the quick stop, the power unit is disabled and the axis movement is no longer controlled by the drive controller; the brakes engage if release override is inactive (F06)

Cause	Check and action
Wrong drive controller design	Check the design and change the drive controller type if necessary
Increased or reduced mechanical friction	Check the service status of the mechanical system of all axes and service them if necessary
Mechanical block	Check the output of all axes and remove the block if necessary
Short deceleration/acceleration times	Check the actual current during the braking process using the scope image (E00); reduce the deceleration and acceleration values if necessary
Clock frequency too high	Check the utilization of the drive, taking into account derating and the configured clock frequency (E20, B24); reduce the configured clock frequency or replace the drive controller if necessary

Tab. 321: Event 39 – Causes and actions

### 19.1.7.11 Event 40: Invalid data

The drive controller is interrupted:

- The power unit is disabled and axis movement is no longer controlled by the drive controller
- The behavior of the brakes depends on the configuration of the safety module and an optional release override (F06)

Cause		Check and action
1: Fault, 2: Block missing, 3: Data security, 4: Checksum, 5: Read only, 6: Read error, 7: Block missing, 8: Wrong/illegal serial number	Invalid data in the internal memory of the drive controller or option module	Determine the affected memory (Z730) and, based on that, replace the drive controller, option module or motor; fault cannot be acknowledged
32: Electronic nameplate	No data available in the electronic nameplate	Deactivate the evaluation of the nameplate or replace the motor (B04); fault cannot be acknowledged
33: Electronic nameplate limit	Invalid data in the electronic nameplate	Deactivate the evaluation of the nameplate or replace the motor (B04); fault cannot be acknowledged
48: Reverse documentation	Defective memory in Paramodul	Replace the Paramodul; fault cannot be acknowledged

Tab. 322: Event 40 – Causes and actions

### 19.1.7.12 Event 41: Temp.MotorTMP

The possible effects depend on the configured level (U15):

- 2: Warning
- 3: Fault

The drive controller is interrupted if:

- A29 = 0: Inactive for Drive Based device controller  
or
- A540 = 0: Disable drive motor coasting for CiA 402 device controller

Response:

- The power unit is disabled and axis movement is no longer controlled by the drive controller
- The brakes are applied in the event of an inactive release override (F06)

The drive controller has a fault and a quick stop occurs if:

- A29 = 1: Active for Drive Based device controller  
or
- A540 = 2: Slow down on quick stop ramp for CiA 402 device controller

Response:

- The axis is stopped by a quick stop; meanwhile, the brakes remain released
- At the end of the quick stop, the power unit is disabled and the axis movement is no longer controlled by the drive controller; the brakes engage if release override is inactive (F06)

Cause	Check and action
Motor temperature sensor connection error	Check the connection and correct it if necessary
Wrong motor design	Check the design and change the motor type if necessary
Surrounding temperatures at the motor too high	Check the surrounding temperature and adjust it if necessary
Mechanical block of the motor	Check the output and remove the block if necessary
Increased or reduced mechanical friction	Check the service status of the mechanical system and service them if necessary

Tab. 323: Event 41 – Causes and actions

### 19.1.7.13 Event 42: TempBrakeRes

The drive controller is interrupted if:

- A29 = 0: Inactive for Drive Based device controller  
or
- A540 = 0: Disable drive motor coasting for CiA 402 device controller

Response:

- The power unit is disabled and axis movement is no longer controlled by the drive controller
- The brakes are applied in the event of an inactive release override (F06)

The drive controller has a fault and a quick stop occurs if:

- A29 = 1: Active for Drive Based device controller  
or
- A540 = 2: Slow down on quick stop ramp for CiA 402 device controller

Response:

- The axis is stopped by a quick stop; meanwhile, the brakes remain released
- At the end of the quick stop, the power unit is disabled and the axis movement is no longer controlled by the drive controller; the brakes engage if release override is inactive (F06)

Cause	Check and action
Short deceleration/acceleration times	Check the DC link voltage during the braking process using the scope image (E03); reduce the deceleration and acceleration values if necessary
Braking resistor too low	Check that the maximum permitted braking resistor power loss is suitable for the application and replace the braking resistor if necessary

Tab. 324: Event 42 – Causes and actions

### 19.1.7.14 Event 43: AI1 wire break

The drive controller is interrupted if:

- A29 = 0: Inactive for Drive Based device controller  
or
- A540 = 0: Disable drive motor coasting for CiA 402 device controller

Response:

- The power unit is disabled and axis movement is no longer controlled by the drive controller
- The brakes are applied in the event of an inactive release override (F06)

The drive controller has a fault and a quick stop occurs if:

- A29 = 1: Active for Drive Based device controller  
or
- A540 = 2: Slow down on quick stop ramp for CiA 402 device controller

Response:

- The axis is stopped by a quick stop; meanwhile, the brakes remain released
- At the end of the quick stop, the power unit is disabled and the axis movement is no longer controlled by the drive controller; the brakes engage if release override is inactive (F06)

Cause	Check and action
Connection error	Check the connection and correct it if necessary
Inconsistent parameterization	Check wire break monitoring, taking into account the configured operating mode, and correct it if necessary (F15, F16)

Tab. 325: Event 43 – Causes and actions

### 19.1.7.15 Event 44: External fault 1

The drive controller is interrupted if:

- A29 = 0: Inactive for Drive Based device controller  
or
- A540 = 0: Disable drive motor coasting for CiA 402 device controller

Response:

- The power unit is disabled and axis movement is no longer controlled by the drive controller
- The brakes are applied in the event of an inactive release override (F06)

The drive controller has a fault and a quick stop occurs if:

- A29 = 1: Active for Drive Based device controller  
or
- A540 = 2: Slow down on quick stop ramp for CiA 402 device controller

Response:

- The axis is stopped by a quick stop; meanwhile, the brakes remain released
- At the end of the quick stop, the power unit is disabled and the axis movement is no longer controlled by the drive controller; the brakes engage if release override is inactive (F06)

Cause	Check and action
Application-specific	Application-specific

Tab. 326: Event 44 – Causes and actions

### 19.1.7.16 Event 45: Overtemp.motor i2t

The possible effects depend on the parameterized level (U10):

- 0: Inactive
- 1: Message
- 2: Warning
- 3: Fault

The drive controller is interrupted if:

- A29 = 0: Inactive for Drive Based device controller  
or
- A540 = 0: Disable drive motor coasting for CiA 402 device controller

Response:

- The power unit is disabled and axis movement is no longer controlled by the drive controller
- The brakes are applied in the event of an inactive release override (F06)

The drive controller has a fault and a quick stop occurs if:

- A29 = 1: Active for Drive Based device controller  
or
- A540 = 2: Slow down on quick stop ramp for CiA 402 device controller

Response:

- The axis is stopped by a quick stop; meanwhile, the brakes remain released
- At the end of the quick stop, the power unit is disabled and the axis movement is no longer controlled by the drive controller; the brakes engage if release override is inactive (F06)

Cause	Check and action
Wrong motor design	Check the design and change the motor type if necessary
Mechanical block of the motor	Check the output and remove the block if necessary
Increased or reduced mechanical friction	Check the service status of the mechanical system and service them if necessary

Tab. 327: Event 45 – Causes and actions

### 19.1.7.17 Event 46: Low voltage

The possible effects depend on the configured level (U00):

- 0: Inactive
- 1: Message
- 2: Warning
- 3: Fault

The drive controller is interrupted if:

- A29 = 0: Inactive for Drive Based device controller  
or
- A540 = 0: Disable drive motor coasting for CiA 402 device controller

Response:

- The power unit is disabled and axis movement is no longer controlled by the drive controller
- The brakes are applied in the event of an inactive release override (F06)

The drive controller has a fault and a quick stop occurs if:

- A29 = 1: Active for Drive Based device controller  
or
- A540 = 2: Slow down on quick stop ramp for CiA 402 device controller

Response:

- The axis is stopped by a quick stop; meanwhile, the brakes remain released
- At the end of the quick stop, the power unit is disabled and the axis movement is no longer controlled by the drive controller; the brakes engage if release override is inactive (F06)

Cause	Check and action
Supply voltage does not correspond to the configured supply voltage	Check the supply voltage, parameterized supply voltage and undervoltage limit and correct them if necessary (A36, A35)
Supply voltage below undervoltage limit	Check undervoltage limit and correct it if necessary (A35)

Tab. 328: Event 46 – Causes and actions



### 19.1.7.18 Event 47: Torque/force-max. limit

The possible effects depend on the configured level (U20):

- 0: Inactive
- 1: Message
- 2: Warning
- 3: Fault

The drive controller is interrupted if:

- A29 = 0: Inactive for Drive Based device controller  
or
- A540 = 0: Disable drive motor coasting for CiA 402 device controller

Response:

- The power unit is disabled and axis movement is no longer controlled by the drive controller
- The brakes are applied in the event of an inactive release override (F06)

The drive controller has a fault and a quick stop occurs if:

- A29 = 1: Active for Drive Based device controller  
or
- A540 = 2: Slow down on quick stop ramp for CiA 402 device controller

Response:

- The axis is stopped by a quick stop; meanwhile, the brakes remain released
- At the end of the quick stop, the power unit is disabled and the axis movement is no longer controlled by the drive controller; the brakes engage if release override is inactive (F06)

Cause	Check and action
Incorrectly selected torque/force limits	Check the general machine limit and adjust it if necessary (C03, C05); check the application limits and the parameters dependent on the operating mode and adjust them if necessary (Drive Based C132, C133 or CiA 402 A559)
Wrong motor design	Check the design and change the motor type if necessary
Mechanical block	Check the output and remove the block if necessary
Brake closed	Check the connection, supply voltage and parameterization and correct them if necessary (F00)
Connection error at the motor	Check the connection and correct it if necessary
Connection error at the encoder	Check the connection and correct it if necessary
Wrong encoder measurement direction	Compare the attachment and measurement direction of the encoder with the corresponding values of the H parameters and correct them if necessary

Tab. 329: Event 47 – Causes and actions

### 19.1.7.19 Event 48: Brake release monitoring

The possible effects depend on the configured level (U26).

The drive controller is interrupted if:

- A29 = 0: Inactive for Drive Based device controller  
or
- A540 = 0: Disable drive motor coasting for CiA 402 device controller

Response:

- The power unit is disabled and axis movement is no longer controlled by the drive controller
- The brakes are applied in the event of an inactive release override (F06)

The drive controller has a fault and a quick stop occurs if:

- A29 = 1: Active for Drive Based device controller  
or
- A540 = 2: Slow down on quick stop ramp for CiA 402 device controller

Response:

- The axis is stopped by a quick stop; meanwhile, the brakes remain released
- At the end of the quick stop, the power unit is disabled and the axis movement is no longer controlled by the drive controller; the brakes engage if release override is inactive (F06)

Cause	Check and action
Connection error	Check the connection and correct it if necessary
Release monitoring not adjusted	Adjust release monitoring

Tab. 330: Event 48 – Causes and actions

### 19.1.7.20 Event 49: Brake

The drive controller is interrupted if:

- A29 = 0: Inactive for Drive Based device controller  
or
- A540 = 0: Disable drive motor coasting for CiA 402 device controller

Response:

- The power unit is disabled and axis movement is no longer controlled by the drive controller
- The brakes are applied in the event of an inactive release override (F06)

The drive controller has a fault and a quick stop occurs if:

- A29 = 1: Active for Drive Based device controller  
or
- A540 = 2: Slow down on quick stop ramp for CiA 402 device controller

Response:

- The axis is stopped by a quick stop; meanwhile, the brakes remain released
- At the end of the quick stop, the power unit is disabled and the axis movement is no longer controlled by the drive controller; the brakes engage if release override is inactive (F06)

Cause		Check and action
1: Brake supply voltage too low	Supply voltage connection error	Check the connection and correct it if necessary
	Supply voltage too low	Compare the specification of the power supply with the corresponding specifications of STOBER and replace the voltage source if necessary
2: Brake 1: no feedback	Feedback connection error	Check the connection and configured brake connection and correct them if necessary (F93)
	Wrong contact type	Check the contact type and use an N/O contact if necessary
3: Brake 1: short circuit, 4: Brake 1: open load	Connection error	Check the connection and correct it if necessary
	Defective power cable	Check the cable and replace it if necessary
	Indirect brake connection	Check the connection and configured brake connection and correct them if necessary (F93)
5: Brake 2: no feedback	Feedback connection error	Check the connection and configured brake connection and correct them if necessary (F93)
6: Brake 2: short circuit, 7: Brake 2: open load	Connection error	Check the connection and correct it if necessary
	Defective power cable	Check the cable and replace it if necessary
	Indirect brake connection	Check the connection and configured brake connection and correct them if necessary (F93)
9: Brake 1 slips	Wrong brake design	Check the design and change the brake type or motor type if necessary
	Brake wear	Check the brake for wear and replace it if necessary

Tab. 331: Event 49 – Causes and actions

### 19.1.7.21 Event 50: Safety module

The drive controller is interrupted:

- The power unit is disabled and axis movement is no longer controlled by the drive controller
- The behavior of the brakes depends on the configuration of the safety module and an optional release override (F06)

Cause		Check and action
1: Inconsistent request (single channel)	Connection error	Check the connection and correct it if necessary; error cannot be acknowledged until both STO channels have been requested for at least 100 ms
2: Wrong safety module	The projected E53 safety module does not match the E54[0] detected by the system	Check the project configuration and drive controller and correct the project configuration or exchange the drive controller if necessary; fault cannot be acknowledged
4: PowerUp sequence error	Defective safety module	Exchange drive controller; fault cannot be acknowledged
6: Fatal error	Safety module is in an error state	Determine offset and index from the active error code (see S02, S03) and take the appropriate measures as described in the SE6 diagnostics manual; fault cannot be acknowledged
8: SE6 doesn't start	Faulty synchronization between drive controller and safety module when starting the device	Check the drive controller firmware and, if necessary, update to version 6.3-E or higher, then restart the drive controller; fault cannot be acknowledged
10: SE6 safety config. missing in Paramodule	No safety configuration available in the Paramodul	Save safety configuration (A00)
11: SE6 safety config. from Paramodul activated	New safety configuration activated in Paramodul	–
12: SE6 safety config. missing in Paramodule&safety module	No valid safety configuration available in safety module and Paramodul	Create a safety configuration in PASmotion, use DriveControlSuite to transmit it to the drive controller and save it there (A00); fault cannot be acknowledged
13: SE6 activation error	Faulty activation of the safety configuration	Restart the drive controller and activate the safety configuration or start the drive controller without the Paramodul, then create a new safety configuration in PASmotion, use DriveControlSuite to transmit it to the drive controller and save it there (A00); fault cannot be acknowledged
15: SE6 error	Safety module is in an error state	Determine offset and index from the active error code (PASmotion Error stack or S02, S03) and <a href="#">take the appropriate measures [► 381]</a>

Tab. 332: Event 50 – Causes and actions

### 19.1.7.22 Event 51: Virtual master software limit switch

The possible effects depend on the configured level (U24).

- 0: Inactive
- 1: Message
- 3: Fault

The drive controller is interrupted if:

- A29 = 0: Inactive for Drive Based device controller  
or
- A540 = 0: Disable drive motor coasting for CiA 402 device controller

Response:

- The power unit is disabled and axis movement is no longer controlled by the drive controller
- The brakes are applied in the event of an inactive release override (F06)

The drive controller has a fault and a quick stop occurs if:

- A29 = 1: Active for Drive Based device controller  
or
- A540 = 2: Slow down on quick stop ramp for CiA 402 device controller

Response:

- The axis is stopped by a quick stop; meanwhile, the brakes remain released
- At the end of the quick stop, the power unit is disabled and the axis movement is no longer controlled by the drive controller; the brakes engage if release override is inactive (F06)

Event 51: Virtual master software limit switch only affects the device control of the axis. A quick stop of the virtual master can also be triggered with G57.

Cause		Check and action
1: SW-limit switch positive, 2: SW-limit switch negative	End of the travel range reached	Move in the travel range in the direction opposite the limit switch
	Travel range too small	Check the positions of the software limit switch and correct them if necessary (G146, G147)
3: +/- 31 bit computing limit reached	Computing limit of the data type reached	Check the command sequences for multiple successive 3: MC_MoveAdditive commands without a breakpoint and the number of decimal places of the axis model and reduce them if necessary (G46)

Tab. 333: Event 51 – Causes and actions

### 19.1.7.23 Event 52: Communication

The drive controller is interrupted if:

- A29 = 0: Inactive for Drive Based device controller  
or
- A540 = 0: Disable drive motor coasting for CiA 402 device controller

Response:

- The power unit is disabled and axis movement is no longer controlled by the drive controller
- The brakes are applied in the event of an inactive release override (F06)

The drive controller has a fault and a quick stop occurs if:

- A29 = 1: Active for Drive Based device controller  
or
- A540 = 2: Slow down on quick stop ramp for CiA 402 device controller

Response:

- The axis is stopped by a quick stop; meanwhile, the brakes remain released
- At the end of the quick stop, the power unit is disabled and the axis movement is no longer controlled by the drive controller; the brakes engage if release override is inactive (F06)

Cause		Check and action
1: CAN Life Guarding Event	Missing node/life guarding remote request	Check the node/life guarding settings in the CANopen master and drive controller and correct them if necessary (A203, A204)
4: PZD-Timeout	Missing process data	Check the cycle time in the controller and tolerated failure time for monitoring the PZD communication in the drive controller and correct if necessary (A109)
5: Wrong or missing X3 firmware	Firmware error	Replacing the drive controller
6: EtherCAT PDO-Timeout	Missing process data	Check the task cycle time in the EtherCAT master and the timeout time in the drive controller and correct them if necessary (A258)
7: Reserved	Synchronization error	Check the synchronization settings in the EtherCAT master and correct them if necessary
	Connection error	Check the connection and shielding and correct them if necessary
8: IGB µC failure	Microprocessor faulty	Check the connection and shielding and correct them if necessary; replace the drive controller if necessary
9: IGB serie lost frames	Connection error	Check the connection and correct it if necessary; restart the drive controller to update IGB
	Defective IGB connecting cable	Check the cable and replace it if necessary; restart the drive controller to update IGB
10: IGB partner serie lost frames	Error at other node (cause: 9: IGB serie lost frames)	Eliminate error at affected node
11: IGB synchronization error	Connection error	Check the connection and correct it if necessary; restart the drive controller to update IGB
	Defective IGB connecting cable	Check the cable and replace it if necessary; restart the drive controller to update IGB
14: PZD parameter figure faulty	Missing mapping	Check the mapping for unmappable parameters and correct them if necessary

Tab. 334: Event 52 – Causes and actions

### 19.1.7.24 Event 53: Limit switch

The drive controller is interrupted if:

- A29 = 0: Inactive for Drive Based device controller  
or
- A540 = 0: Disable drive motor coasting for CiA 402 device controller

Response:

- The power unit is disabled and axis movement is no longer controlled by the drive controller
- The brakes are applied in the event of an inactive release override (F06)

The drive controller has a fault and a quick stop occurs if:

- A29 = 1: Active for Drive Based device controller  
or
- A540 = 2: Slow down on quick stop ramp for CiA 402 device controller

Response:

- The axis is stopped by a quick stop; meanwhile, the brakes remain released
- At the end of the quick stop, the power unit is disabled and the axis movement is no longer controlled by the drive controller; the brakes engage if release override is inactive (F06)

Cause		Check and action
1: Hardware-Limit-Switch positive, 2: Hardware-Limit-Switch negative	End of the travel range reached	Move in the travel range in the direction opposite the limit switch
	Connection error	Check the connection and source parameters and correct them if necessary (I101, I102)
	Defective cable	Check the cable and replace it if necessary
3: SW-limit switch positive, 4: SW-limit switch negative	End of the travel range reached	Move in the travel range in the direction opposite the limit switch
	Travel range too small	Check the positions of the software limit switches and correct them if necessary (Drive Based I50, I51 or CiA A570[0], A570[1])
5: +/- 31 bit computing limit reached	Computing limit of the data type reached	Check the command sequences for multiple successive 3: MC_MoveAdditive commands without a breakpoint and the number of decimal places of the axis model and reduce them if necessary (I06)
6: Linear motor moving range	Axis is 200 m away from the commutation reference point	Check the axis model and correct it if necessary
7: Both limit switches not connected	Connection error	Check the connection and source parameters and correct them if necessary (I101, I102)
	Defective cable	Check the cable and replace it if necessary

Tab. 335: Event 53 – Causes and actions

### 19.1.7.25 Event 54: Following error

The possible effects depend on the configured level (U22).

- 0: Inactive
- 1: Message
- 2: Warning
- 3: Fault

The drive controller is interrupted if:

- A29 = 0: Inactive for Drive Based device controller  
or
- A540 = 0: Disable drive motor coasting for CiA 402 device controller

Response:

- The power unit is disabled and axis movement is no longer controlled by the drive controller
- The brakes are applied in the event of an inactive release override (F06)

The drive controller has a fault and a quick stop occurs if:

- A29 = 1: Active for Drive Based device controller  
or
- A540 = 2: Slow down on quick stop ramp for CiA 402 device controller

Response:

- The axis is stopped by a quick stop; meanwhile, the brakes remain released
- At the end of the quick stop, the power unit is disabled and the axis movement is no longer controlled by the drive controller; the brakes engage if release override is inactive (F06)

Cause	Check and action
Incorrectly selected torque/force limits	Check the general machine limit and adjust it if necessary (C03, C05); check the application limits and adjust them if necessary (Drive Based: C132, C133 and the parameters dependent on the operating mode; CiA 402: A559)
Maximum permitted lag is too small	Check the maximum permitted following error and correct it if necessary (Drive Based: I21; CiA 402: A546)
Mechanical block	Check the output and remove the block if necessary
Brake closed	Check the connection, supply voltage and parameterization and correct them if necessary (F00)

Tab. 336: Event 54 – Causes and actions



### 19.1.7.26 Event 55: Option module

The drive controller is interrupted if:

- A29 = 0: Inactive for Drive Based device controller  
or
- A540 = 0: Disable drive motor coasting for CiA 402 device controller

Response:

- The power unit is disabled and axis movement is no longer controlled by the drive controller
- The brakes are applied in the event of an inactive release override (F06)

The drive controller has a fault and a quick stop occurs if:

- A29 = 1: Active for Drive Based device controller  
or
- A540 = 2: Slow down on quick stop ramp for CiA 402 device controller

Response:

- The axis is stopped by a quick stop; meanwhile, the brakes remain released
- At the end of the quick stop, the power unit is disabled and the axis movement is no longer controlled by the drive controller; the brakes engage if release override is inactive (F06)

Cause		Check and action
1: Communication module wrong/missing	No communication module or wrong type installed	Compare the projecting with the installation; correct the projecting or installation if necessary; fault cannot be acknowledged
2: EC6 failure, 3: CA6 failure, 5: PN6 failure	Defective or incorrectly installed communication module	Removal and installation of the communication module; replace the communication module if necessary; fault cannot be acknowledged
6: Communication module incompatible	Outdated communication module hardware	Install a communication module with the right hardware version; fault cannot be acknowledged
7: Terminal module wrong/missing	No terminal module or wrong type installed	Compare the projecting with the installation; correct the projecting or installation if necessary; fault cannot be acknowledged
8: IO6 failure, 9: RI6 failure, 10: XI6 failure	Defective or incorrectly installed terminal module	Removal and installation of the terminal module; replace the terminal module if necessary; fault cannot be acknowledged
12: XI6 24V supply	Connection error	Check the connection and correct it if necessary
	Defective cable	Check the cable and replace it if necessary
	Supply voltage too low	Check the voltage source and increase the voltage if necessary
13: Terminal module incompatible	Outdated terminal module hardware	Install the terminal module with the right hardware version; fault cannot be acknowledged

Tab. 337: Event 55 – Causes and actions

### 19.1.7.27 Event 56: Overspeed

The drive controller is interrupted if:

- U30 = 0: Inactive

Response:

- The power unit is disabled and axis movement is no longer controlled by the drive controller
- The brakes are applied in the event of an inactive release override (F06)

The drive controller is interrupted with emergency braking if:

- U30 = 1: Active and
- A29 = 1: Active for Drive Based device controller  
or
- U30 = 1: Active and
- A540 = 2: Slow down on quick stop ramp for CiA 402 device controller

Response:

- The axis is stopped by emergency braking; the brakes are applied in the event of an inactive release override (F06)
- At the end of emergency braking, the power unit is disabled and axis movement is no longer controlled by the drive controller

Emergency braking is only possible for the synchronous servo, torque and synchronous linear motor types.

The event is only triggered if the checking rules for Enable-on are violated.

Cause		Check and action
1: Motor encoder, 2: Position encoder, 3: Motor & position encoder	Maximum permitted velocity too small	Check the maximum permitted velocity and increase it if necessary (I10)
	Overshooting control system	Check the actual velocity using the scope image (Sensing time: 250 μs, actual motor velocity: E15, E91; actual position velocity I88) and, if necessary, reduce the gain of the control system (I20, C31)
1: Motor encoder, 3: Motor & position encoder	Wrong commutation offset	Check the commutation offset using the Test phase action (B40)
	Faulty motor encoder	Check the velocity display of the encoder at a standstill (E15, E91) and replace the encoder if necessary
2: Position encoder, 3: Motor & position encoder	Faulty position encoder	Check the velocity display of the encoder at a standstill (I88) and replace the encoder if necessary

Tab. 338: Event 56 – Causes and actions

### 19.1.7.28 Event 57: Runtime requirement

The drive controller is interrupted if:

- A29 = 0: Inactive for Drive Based device controller  
or
- A540 = 0: Disable drive motor coasting for CiA 402 device controller

Response:

- The power unit is disabled and axis movement is no longer controlled by the drive controller
- The brakes are applied in the event of an inactive release override (F06)

The drive controller has a fault and a quick stop occurs if:

- A29 = 1: Active for Drive Based device controller  
or
- A540 = 2: Slow down on quick stop ramp for CiA 402 device controller

Response:

- The axis is stopped by a quick stop; meanwhile, the brakes remain released
- At the end of the quick stop, the power unit is disabled and the axis movement is no longer controlled by the drive controller; the brakes engage if release override is inactive (F06)

Cause		Check and action
3: RT3, 2: RT2,  5: RT5	Exceeding the cycle time	Check the utilization (E191) and increase the cycle time if necessary (A150)

Tab. 339: Event 57 – Causes and actions

### 19.1.7.29 Event 58: Encoder simulation

The drive controller is interrupted if:

- A29 = 0: Inactive for Drive Based device controller  
or
- A540 = 0: Disable drive motor coasting for CiA 402 device controller

Response:

- The power unit is disabled and axis movement is no longer controlled by the drive controller
- The brakes are applied in the event of an inactive release override (F06)

The drive controller has a fault and a quick stop occurs if:

- A29 = 1: Active for Drive Based device controller  
or
- A540 = 2: Slow down on quick stop ramp for CiA 402 device controller

Response:

- The axis is stopped by a quick stop; meanwhile, the brakes remain released
- At the end of the quick stop, the power unit is disabled and the axis movement is no longer controlled by the drive controller; the brakes engage if release override is inactive (F06)

Cause		Check and action
1: X4 maximum speed	Input velocity too high	Check the source of the velocity being simulated and adjust it if necessary (H80)
3: X120 channel A/Clk	Defective encoder cable	Check the cable and replace it if necessary

Tab. 340: Event 58 – Causes and actions

### 19.1.7.30 Event 59: Overtemperature drive controller i2t

The drive controller is interrupted if:

- A29 = 0: Inactive for Drive Based device controller  
or
- A540 = 0: Disable drive motor coasting for CiA 402 device controller

Response:

- The power unit is disabled and axis movement is no longer controlled by the drive controller
- The brakes are applied in the event of an inactive release override (F06)

The drive controller has a fault and a quick stop occurs if:

- A29 = 1: Active for Drive Based device controller  
or
- A540 = 2: Slow down on quick stop ramp for CiA 402 device controller

Response:

- The axis is stopped by a quick stop; meanwhile, the brakes remain released
- At the end of the quick stop, the power unit is disabled and the axis movement is no longer controlled by the drive controller; the brakes engage if release override is inactive (F06)

Cause	Check and action
Wrong drive controller design	Check the design and change the drive controller type if necessary; the fault can only be acknowledged 30 s after the cause has been corrected
Increased or reduced mechanical friction	Check the service status of the mechanical system and service them if necessary; the fault can only be acknowledged 30 s after the cause has been corrected
Short deceleration/acceleration times	Check the actual current during the braking process using the scope image (E00); reduce the deceleration and acceleration values if necessary; the fault can only be acknowledged 30 s after the cause has been corrected
Clock frequency too high	Check the utilization of the drive, taking into account derating and the configured clock frequency (E20, B24); reduce the configured clock frequency or replace the drive controller if necessary; the fault can only be acknowledged 30 s after the cause has been corrected

Tab. 341: Event 59 – Causes and actions

### 19.1.7.31 Event 60: Application event 0 – Event 67: Application event 7

The possible effects depend on the configured level (U100, U110, U120, U130, U140, U150, U160, U170):

- 0: Inactive
- 1: Message
- 2: Warning
- 3: Fault

The drive controller is interrupted if:

- A29 = 0: Inactive for Drive Based device controller  
or
- A540 = 0: Disable drive motor coasting for CiA 402 device controller

Response:

- The power unit is disabled and axis movement is no longer controlled by the drive controller
- The brakes are applied in the event of an inactive release override (F06)

The drive controller has a fault and a quick stop occurs if:

- A29 = 1: Active for Drive Based device controller  
or
- A540 = 2: Slow down on quick stop ramp for CiA 402 device controller

Response:

- The axis is stopped by a quick stop; meanwhile, the brakes remain released
- At the end of the quick stop, the power unit is disabled and the axis movement is no longer controlled by the drive controller; the brakes engage if release override is inactive (F06)

Cause	Check and action
Application-specific	Application-specific

Tab. 342: Events 60 – 67 – Causes and actions

### 19.1.7.32 Event 68: External fault 2

The drive controller is interrupted if:

- A29 = 0: Inactive for Drive Based device controller  
or
- A540 = 0: Disable drive motor coasting for CiA 402 device controller

Response:

- The power unit is disabled and axis movement is no longer controlled by the drive controller
- The brakes are applied in the event of an inactive release override (F06)

The drive controller has a fault and a quick stop occurs if:

- A29 = 1: Active for Drive Based device controller  
or
- A540 = 2: Slow down on quick stop ramp for CiA 402 device controller

Response:

- The axis is stopped by a quick stop; meanwhile, the brakes remain released
- At the end of the quick stop, the power unit is disabled and the axis movement is no longer controlled by the drive controller; the brakes engage if release override is inactive (F06)

Cause	Check and action
Application-specific	Application-specific

Tab. 343: Event 68 – Causes and actions

### 19.1.7.33 Event 69: Motor connection

The possible effects depend on the configured level (U12).

- 0: Inactive
- 3: Fault

The drive controller is interrupted if:

- A29 = 0: Inactive for Drive Based device controller  
or
- A540 = 0: Disable drive motor coasting for CiA 402 device controller

Response:

- The power unit is disabled and axis movement is no longer controlled by the drive controller
- The brakes are applied in the event of an inactive release override (F06)

The drive controller has a fault and a quick stop occurs if:

- A29 = 1: Active for Drive Based device controller  
or
- A540 = 2: Slow down on quick stop ramp for CiA 402 device controller

Response:

- The axis is stopped by a quick stop; meanwhile, the brakes remain released
- At the end of the quick stop, the power unit is disabled and the axis movement is no longer controlled by the drive controller; the brakes engage if release override is inactive (F06)

Cause		Check and action
2: No motor connected	Connection error	Check the connection and correct it if necessary
	Defective power cable	Check the cable and replace it if necessary
3: Wake and Shake failed (Commutation finding with Wake and Shake failed)	Increased or reduced mechanical friction	Check the service status of the mechanical system and service them if necessary
	Mechanical block	Check the output and remove the block if necessary
4: Brake (Commutation finding with Wake and Shake failed)	Brake engaged	Check the control of the brakes and engage the brakes during Wake and Shake using release override if necessary (F06), see <a href="#">Brake control based on control mode</a> [ <a href="#">▶ 286</a> ]

Tab. 344: Event 69 – Causes and actions



### 19.1.7.34 Event 70: Parameter consistency

The drive controller is interrupted:

- The power unit is disabled and axis movement is no longer controlled by the drive controller
- The behavior of the brakes depends on the configuration of the safety module and an optional release override (F06)

The event is only triggered if the checking rules for Enable-on are violated.

Cause		Check and action
1: Wrong encoder model	Encoder model unsuitable for control type	Check the control mode, motor encoder and encoder and correct them if necessary (B20, B26, H parameters)
2: X120 data direction	Use of the X120 interface for evaluation and simulation at the same time	Check the evaluation against the simulation and correct it if necessary (motor: B26; position: I02; H120)
3: B12<->B20	Nominal current of the motor exceeds the drive controller nominal current (4 kHz)	Check the motor nominal current against 150% of the drive controller nominal current at a clock frequency of 4 kHz and, if necessary, reduce the motor nominal current or change the drive controller type (B12, R04[0])
4: B10<->H31	Unsupported combination of resolver/motor number of poles	Check number of poles of the resolver and number of poles of the motor and correct them if necessary (H08, H148, B10)
5: Negative slip frequency	Negative slip	Check the nominal velocity, nominal frequency and number of poles of the motor and, if necessary, correct them (B13, B15, B10)
8: v-max (I10) exceeds maximum (B83)	Maximum permitted velocity exceeds the maximum motor velocity	Check the maximum permitted velocity and the maximum motor velocity and correct them if necessary (I10, B83)
11: Reference retaining	Conditions for reference without tracking not met	Check that the reference is retained and that the measurement range covers the travel range and make corrections if necessary (I46, limited travel range I00: Software limit switch must be parameterized; infinite travel range I00: Measurement range must correspond to the revolution length Drive Based I01 or CiA 402 A568[1] or an entire multiple)
12: Type of axis	Rotational axis model not suitable for synchronous linear motor	Correct the axis type of the axis model (I00)
16: I10 > C11	Maximum permitted velocity is above maximum gear unit input speed	Check the maximum permitted velocity and the maximum gear unit input speed and correct them if necessary (I10, C11)

Tab. 345: Event 70 – Causes and actions

### 19.1.7.35 Event 71: Firmware

Cause 1:

The drive controller is interrupted:

- The power unit is disabled and axis movement is no longer controlled by the drive controller
- The behavior of the brakes depends on the configuration of the safety module and an optional release override (F06)

Cause 3:

The drive controller is interrupted if:

- A29 = 0: Inactive for Drive Based device controller  
or
- A540 = 0: Disable drive motor coasting for CiA 402 device controller

Response:

- The power unit is disabled and axis movement is no longer controlled by the drive controller
- The brakes are applied in the event of an inactive release override (F06)

The drive controller has a fault and a quick stop occurs if:

- A29 = 1: Active for Drive Based device controller  
or
- A540 = 2: Slow down on quick stop ramp for CiA 402 device controller

Response:

- The axis is stopped by a quick stop; meanwhile, the brakes remain released
- At the end of the quick stop, the power unit is disabled and the axis movement is no longer controlled by the drive controller; the brakes engage if release override is inactive (F06)

Cause		Check and action
1: Firmware defective	Defective firmware	Update the firmware; fault cannot be acknowledged
	Defective drive controller	Exchange drive controller; fault cannot be acknowledged
3: CRC-error	Defective firmware	Update the firmware; fault cannot be acknowledged
	Defective drive controller	Check for repeated triggering of the event after a restart; if necessary, replace the drive controller

Tab. 346: Event 71 – Causes and actions

### 19.1.7.36 Event 72: Brake test timeout – Event 75: Axis 4 brake test timeout

The possible effects depend on the cause. Cause 1 and 2 lead to a fault, cause 3 is output as a message.

The drive controller is interrupted:

- The power unit is disabled and axis movement is no longer controlled by the drive controller
- The behavior of the brakes depends on the configuration of the safety module and an optional release override (F06)

Cause		Check and action
1: B311timeout:B300 mandatory	Brake management is active and the timeout for the brake test runs out twice	Test the brake (B300, S18); can be acknowledged for a period of 5 min in order to be able to carry out the test brake action
2: Brake defective:B300 mandatory	Test holding torque not met during the test brake action	Bed in the brake (B301, B302) and repeat the brake test (B300, S18); can be acknowledged for a period of 5 min in order to be able to carry out the brake test
	Faulty encoder test run during test brake action	Replace the encoder or motor and repeat the brake test (B300, S18); can be acknowledged for a time period of 5 min in order to be able to carry out the brake test
3: Brake test necessary	Brake management is active and the timeout for the brake test runs out once	Carry out the test brake action (B300, S18); can be acknowledged for a period of 5 min in order to be able to carry out the brake test

Tab. 347: Events 72 – 75 – Causes and actions

### 19.1.7.37 Event 76: Position encoder

The drive controller is interrupted if:

- U30 = 0: Inactive and
- A29 = 0: Inactive for Drive Based device controller  
or
- U30 = 1: Active and
- A540 = 0: Disable drive motor coasting for CiA 402 device controller

Response:

- The power unit is disabled and axis movement is no longer controlled by the drive controller
- The brakes are applied in the event of an inactive release override (F06)

The drive controller has a fault and a quick stop occurs if:

- A29 = 0: Inactive for Drive Based device controller  
or
- A540 = 2: Slow down on quick stop ramp for CiA 402 device controller

Response:

- The axis is stopped by a quick stop; meanwhile, the brakes remain released
- At the end of the quick stop, the power unit is disabled and the axis movement is no longer controlled by the drive controller; the brakes engage if release override is inactive (F06)

The drive controller is interrupted with emergency braking if:

- U30 = 1: Active and
- A29 = 1: Active for Drive Based device controller  
or
- U30 = 1: Active and
- A540 = 2: Slow down on quick stop ramp for CiA 402 device controller

Response:

- The axis is stopped by emergency braking; the brakes are applied in the event of an inactive release override (F06)
- At the end of emergency braking, the power unit is disabled and axis movement is no longer controlled by the drive controller

Emergency braking is only possible for the synchronous servo, torque and synchronous linear motor types.

The reference is deleted (I86).

Cause		Check and action
1: Parameter <-> encoder	Inconsistent parameterization	Compare the specification of the connected encoder to the corresponding values of the H parameters and correct them if necessary
2: X4 maximum speed	Exceeded encoder maximum velocity	Check the actual velocity during a movement using the scope image (I88) and adjust the permitted encoder maximum velocity if necessary (I297)
	Connection error	Check the connection and shielding and correct them if necessary

Cause		Check and action
6: X4 EnDat encoder found	Inconsistent parameterization	Compare the connected encoder to the parameterized encoder and correct it if necessary (H00)
7: X4 channel A/incremental	Connection error	Check the connection and correct it if necessary
8: X4 no encoder found	Connection error	Check the connection and correct it if necessary; restart the drive controller to switch the encoder supply back on
	Defective encoder cable	Check the cable and replace it if necessary; restart the drive controller to switch the encoder supply back on
	Defective power supply	Check the encoder power supply and correct it if necessary; restart the drive controller to switch the encoder supply back on
	Inconsistent parameterization	Compare the connected encoder to the parameterized encoder and correct it if necessary (H00); restart the drive controller to switch encoder supply back on
10: X4 channel A/Ck, 11: X4 channel B/Dat, 12: X4 channel 0	Defective encoder cable	Check the cable and replace it if necessary
13: X4-EnDat alarm	Defective EnDat encoder	Replace the motor; EnDat 2.1 digital, EnDat 2.2 digital: Fault cannot be acknowledged
14: X4 EnDat CRC, 15: X4 double transmission	Connection error	Check the connection and correct it if necessary
	Electromagnetic interference	<a href="#">Take EMC recommendations into account [▶ 144]</a> and, if necessary, increase the fault tolerance (I298)
16: X4 busy	Defective encoder cable	Check the cable and replace it if necessary
	Inconsistent parameterization	Compare the connected encoder to the parameterized encoder and correct it if necessary (H00)
	Incompatible encoder	Compare the specification of the encoder with the corresponding specifications from STOBER and replace the encoder or motor if necessary
17: EBI encoder low battery	Battery in battery module weak	Replace the battery; reference is not deleted by the event
18: EBI encoder battery empty	Battery in battery module empty	Replace the battery
	Initial connection	–
	Connection error	Check the connection and correct it if necessary
	Defective encoder cable	Check the cable and replace it if necessary
	Faulty battery module	Check the battery module and replace it if necessary
19: Alarm bit	Encoder fault	Check the specification of the encoder regarding the alarm bit
20: Resolver carrier, 21: Resolver sin/cos undervoltage, 22: Resolver sin/cos overvoltage	Defective encoder cable	Check the cable and replace it if necessary
	Incompatible encoder	Compare the specification of the encoder with the corresponding specifications from STOBER and replace the encoder or motor if necessary; fault cannot be acknowledged
24: Resolver failure	Defective encoder cable	Check the cable and replace it if necessary

Cause		Check and action
30: X120 wire break	Defective encoder cable	Check the cable and replace it if necessary
35: X120 double transmission	Defective encoder cable	Check the cable and replace it if necessary; fault cannot be acknowledged
	Inconsistent double transmission	Check the specification of the connected encoder and deactivate the double transmission (H128) or replace the encoder if necessary
	Incompatible encoder	Compare the specification of the encoder with the corresponding specifications from STOBER and replace the encoder or motor if necessary
36: X120 busy	Defective encoder cable	Check the cable and replace it if necessary
	Inconsistent parameterization	Compare the connected encoder to the parameterized encoder and correct it if necessary (H120)
	Incompatible encoder	Compare the specification of the encoder with the corresponding specifications from STOBER and replace the encoder or motor if necessary
43: X140 EnDat alarm	Defective EnDat encoder	Replace encoder or motor
44: X140 EnDat CRC	Connection error	Check the connection and shielding and correct them if necessary
	Electromagnetic interference	<a href="#">Take EMC recommendations into account [► 144]</a> and, if necessary, increase the fault tolerance (I298)

Tab. 348: Event 76 – Causes and actions

### 19.1.7.38 Event 77: Master encoder

The drive controller is interrupted if:

- A29 = 0: Inactive for Drive Based device controller  
or
- A540 = 0: Disable drive motor coasting for CiA 402 device controller

Response:

- The power unit is disabled and axis movement is no longer controlled by the drive controller
- The brakes are applied in the event of an inactive release override (F06)

The drive controller has a fault and a quick stop occurs if:

- A29 = 1: Active for Drive Based device controller  
or
- A540 = 2: Slow down on quick stop ramp for CiA 402 device controller

Response:

- The axis is stopped by a quick stop; meanwhile, the brakes remain released
- At the end of the quick stop, the power unit is disabled and the axis movement is no longer controlled by the drive controller; the brakes engage if release override is inactive (F06)

The reference is deleted (G89).

Cause		Check and action
1: Parameter <-> encoder	Inconsistent parameterization	Compare the specification of the connected encoder to the corresponding values of the H parameters and correct them if necessary
2: X4 maximum speed	Exceeded encoder maximum velocity	Check the actual velocity during a movement using the scope image (G105) and adjust the permitted encoder maximum velocity if necessary (G297)
	Connection error	Check the connection and shielding and correct them if necessary
6: X4 EnDat encoder found	Inconsistent parameterization	Compare the connected encoder to the parameterized encoder and correct it if necessary (H00)
7: X4 channel A/incremental	Connection error	Check the connection and correct it if necessary
8: X4 no encoder found	Connection error	Check the connection and correct it if necessary; restart the drive controller to switch the encoder supply back on
	Defective encoder cable	Check the cable and replace it if necessary; restart the drive controller to switch the encoder supply back on
	Defective power supply	Check the encoder power supply and correct it if necessary; restart the drive controller to switch the encoder supply back on
	Inconsistent parameterization	Compare the connected encoder to the parameterized encoder and correct it if necessary (H00); restart the drive controller to switch encoder supply back on
10: X4 channel A/Ck, 11: X4 channel B/Dat, 12: X4 channel 0	Defective encoder cable	Check the cable and replace it if necessary

Cause		Check and action
13: X4-EnDat alarm	Defective EnDat encoder	Replace the motor; EnDat 2.1 digital, EnDat 2.2 digital: Fault cannot be acknowledged
14: X4 EnDat CRC, 15: X4 double transmission	Connection error	Check the connection and correct it if necessary
	Electromagnetic interference	<a href="#">Take EMC recommendations into account [► 144]</a> and, if necessary, increase the fault tolerance (G298)
16: X4 busy	Defective encoder cable	Check the cable and replace it if necessary
	Inconsistent parameterization	Compare the connected encoder to the parameterized encoder and correct it if necessary (H00)
	Incompatible encoder	Compare the specification of the encoder with the corresponding specifications from STOBER and replace the encoder if necessary
17: EBI encoder low battery	Battery in battery module weak	Replace the battery; reference is not deleted by the event
18: EBI encoder battery empty	Battery in battery module empty	Replace the battery
	Initial connection	–
	Connection error	Check the connection and correct it if necessary
	Defective encoder cable	Check the cable and replace it if necessary
	Faulty battery module	Check the battery module and replace it if necessary
19: Alarm bit	Encoder fault	Check the specification of the encoder regarding the alarm bit
20: Resolver carrier, 21: Resolver sin/cos undervoltage, 22: Resolver sin/cos overvoltage	Defective encoder cable	Check the cable and replace it if necessary
	Incompatible encoder	Compare the specification of the encoder with the corresponding specifications from STOBER and replace the encoder or motor if necessary; fault cannot be acknowledged
24: Resolver failure	Defective encoder cable	Check the cable and replace it if necessary
30: X120 wire break	Defective encoder cable	Check the cable and replace it if necessary
35: X120 double transmission	Defective encoder cable	Check the cable and replace it if necessary; fault cannot be acknowledged
	Inconsistent double transmission	Check the specification of the connected encoder and deactivate the double transmission (H128) or replace the encoder if necessary
	Incompatible encoder	Compare the specification of the encoder with the corresponding specifications from STOBER and replace the encoder or motor if necessary
36: X120 busy	Defective encoder cable	Check the cable and replace it if necessary
	Inconsistent parameterization	Compare the connected encoder to the parameterized encoder and correct it if necessary (H120)
	Incompatible encoder	Compare the specification of the encoder with the corresponding specifications from STOBER and replace the encoder if necessary

Tab. 349: Event 77 – Causes and actions



### 19.1.7.39 Event 78: Position limit cyclic

The drive controller is interrupted if:

- A29 = 0: Inactive for Drive Based device controller  
or
- A540 = 0: Disable drive motor coasting for CiA 402 device controller

Response:

- The power unit is disabled and axis movement is no longer controlled by the drive controller
- The brakes are applied in the event of an inactive release override (F06)

The drive controller has a fault and a quick stop occurs if:

- A29 = 1: Active for Drive Based device controller  
or
- A540 = 2: Slow down on quick stop ramp for CiA 402 device controller

Response:

- The axis is stopped by a quick stop; meanwhile, the brakes remain released
- At the end of the quick stop, the power unit is disabled and the axis movement is no longer controlled by the drive controller; the brakes engage if release override is inactive (F06)

Cause		Check and action
1: Illegal direction	Cyclical set position outside of the software limit switch	Check the set position in the controller and software limit switch in the drive controller and correct it if necessary (CiA 402: A570)
2: Reference value invalid	Cyclical set position outside of the travel range	Check the set position in the controller and travel range in the drive controller and correct it if necessary (CiA 402: A568)
3: Extrapolation time I423 exceeded	Missing update of the cyclical set position or cyclical set velocity	Check the task cycle time in the fieldbus master of the controller and maximum permitted extrapolation in the drive controller and correct it if necessary (I423)

Tab. 350: Event 78 – Causes and actions

### 19.1.7.40 Event 79: Motor/position encoder plausibility

The possible effects depend on the configured level (U28).

- 0: Inactive
- 1: Message
- 3: Fault

The drive controller is interrupted if:

- A29 = 0: Inactive for Drive Based device controller  
or
- A540 = 0: Disable drive motor coasting for CiA 402 device controller

Response:

- The power unit is disabled and axis movement is no longer controlled by the drive controller
- The brakes are applied in the event of an inactive release override (F06)

The drive controller has a fault and a quick stop occurs if:

- A29 = 1: Active for Drive Based device controller  
or
- A540 = 2: Slow down on quick stop ramp for CiA 402 device controller

Response:

- The axis is stopped by a quick stop; meanwhile, the brakes remain released
- At the end of the quick stop, the power unit is disabled and the axis movement is no longer controlled by the drive controller; the brakes engage if release override is inactive (F06)

Cause	Check and action
Connection error	Check the connection and shielding and correct them if necessary
Slip	Check the mechanics between the motor and position encoder and maximum permitted slip and correct them if necessary (I291, I292)
Mechanical damage	Check the mechanics between the motor and position encoder and correct any damage if necessary

Tab. 351: Event 79 – Causes and actions

### 19.1.7.41 Event 80: Illegal action

The drive controller is interrupted:

- The power unit is disabled and axis movement is no longer controlled by the drive controller
- The behavior of the brakes depends on the configuration of the safety module and an optional release override (F06)

Cause		Check and action
1: Illegal	Not supported by the control type	Check the control type and correct it if necessary (B20)
2: Brake	Loaded axis	Remove the axis load and start the action again

Tab. 352: Event 80 – Causes and actions

### 19.1.7.42 Event 81: Motor allocation

The possible effects depend on the configured level (U04):

- 0: Inactive
- 1: Message
- 3: Fault

The drive controller is interrupted:

- The power unit is disabled and axis movement is no longer controlled by the drive controller
- The behavior of the brakes depends on the configuration of the safety module and an optional release override (F06)

Depending on the cause, data for the motor (in the case of a change to the motor or motor type), current controller (in the case of a change to the motor type), brake (in the case of a change to the brake or motor type), temperature sensor (in the case of a change to the temperature sensor or motor type) or motor adapter, gear unit and geared motor (in the case of a change to the gear unit type) are read out of the electronic nameplate and entered in the respective parameters. In the event of a change to the motor, motor type or even just the commutation, the commutation offset (B05) is reset.

Cause		Check and action
1: Different motor type	Modified motor assignment	Check the change to the motor assignment and save the new motor assignment if necessary (A00)
	Modified gear unit assignment	Check the change to the gear unit assignment and save the new assignment if necessary (A00)
32: Different motor, 33: Different motor & brake, 34: Different motor & temperature sensor, 35: Different motor & brake & temperature sensor, 38: Different motor, temperature sensor & gear unit, 64: Different commutation, 65: Different commutation & brake, 66: Different commutation & temperature sensor, 67: Different commutation & brake & temperature sensor, 129: Different brake, 130: Different temperature sensor, 131: Different brake & temperature sensor	Modified motor assignment	Check the change to the motor assignment and save the new assignment if necessary (A00)
36: Different motor & gear unit 37: Different motor, brake & gear unit, 39: Different motor, brake, temperature sensor & gear unit	Modified motor and gear unit assignment	Check the change to the motor and gear unit assignment and save the new assignment if necessary (A00)
150: Temperature sensor unknown	Motor with unknown temperature sensor type	Update the firmware or change the motor

Tab. 353: Event 81 – Causes and actions

### 19.1.7.43 Event 82: Hall sensor

The drive controller is interrupted if:

- U30 = 0: Inactive

Response:

- The power unit is disabled and axis movement is no longer controlled by the drive controller
- The brakes are applied in the event of an inactive release override (F06)

The drive controller is interrupted with emergency braking if:

- U30 = 1: Active and
- A29 = 1: Active for Drive Based device controller  
or
- U30 = 1: Active and
- A540 = 2: Slow down on quick stop ramp for CiA 402 device controller

Response:

- The axis is stopped by emergency braking; the brakes are applied in the event of an inactive release override (F06)
- At the end of emergency braking, the power unit is disabled and axis movement is no longer controlled by the drive controller

Emergency braking is only possible for the synchronous servo, torque and synchronous linear motor types.

Cause		Check and action
1: Invalid sample	Connection error	Check the connection and correct it if necessary
	Signal levels do not correspond to any sector	Check the Hall distance and correct it if necessary (B08)
2: Invalid sequence	Connection error	Check the connection and correct it if necessary
	Direct change between two non-adjacent sectors	Check the Hall distance and correct it if necessary (B08)
3: Signal edge missing	Missing signal change within pole pitch	Check the pole pitch and correct it if necessary (B16)
	Defective Hall sensor	Replace the Hall sensor
4: X120 wire break	Defective encoder cable	Check the cable and replace it if necessary

Tab. 354: Event 82 – Causes and actions

### 19.1.7.44 Event 83: Failure of one/ all phases (mains)

Upon the occurrence of an event, a warning is output initially, becoming a fault after a 10 s warning period.

The drive controller is interrupted if:

- A29 = 0: Inactive for Drive Based device controller  
or
- A540 = 0: Disable drive motor coasting for CiA 402 device controller

Response:

- The power unit is disabled and axis movement is no longer controlled by the drive controller
- The brakes are applied in the event of an inactive release override (F06)

The drive controller has a fault and a quick stop occurs if:

- A29 = 1: Active for Drive Based device controller  
or
- A540 = 2: Slow down on quick stop ramp for CiA 402 device controller

Response:

- The axis is stopped by a quick stop; meanwhile, the brakes remain released
- At the end of the quick stop, the power unit is disabled and the axis movement is no longer controlled by the drive controller; the brakes engage if release override is inactive (F06)

Cause	Check and action
Failure of one or all line phases	Check the line fuse and connection and correct them if necessary

Tab. 355: Event 83 – Causes and actions

### 19.1.7.45 Event 84: Drop in network voltage when power section active

The drive controller is interrupted if:

- U30 = 0: Inactive and
- A29 = 0: Inactive for Drive Based device controller  
or
- U30 = 1: Active and
- A540 = 0: Disable drive motor coasting for CiA 402 device controller

Response:

- The power unit is disabled and axis movement is no longer controlled by the drive controller
- The brakes are applied in the event of an inactive release override (F06)

The drive controller has a fault and a quick stop occurs if:

- A29 = 0: Inactive for Drive Based device controller  
or
- A540 = 2: Slow down on quick stop ramp for CiA 402 device controller

Response:

- The axis is stopped by a quick stop; meanwhile, the brakes remain released
- At the end of the quick stop, the power unit is disabled and the axis movement is no longer controlled by the drive controller; the brakes engage if release override is inactive (F06)

The drive controller is interrupted with emergency braking if:

- U30 = 1: Active and
- A29 = 1: Active for Drive Based device controller  
or
- U30 = 1: Active and
- A540 = 2: Slow down on quick stop ramp for CiA 402 device controller

Response:

- The axis is stopped by emergency braking; the brakes are applied in the event of an inactive release override (F06)
- At the end of emergency braking, the power unit is disabled and axis movement is no longer controlled by the drive controller

Emergency braking is only possible for the synchronous servo, torque and synchronous linear motor types.

A quick stop is not possible when the power supply returns.

Cause	Check and action
Decrease in supply voltage under load	Check the supply voltage for load stability and stabilize the network if necessary
Sporadic power failures	Check the supply voltage for stability and stabilize the network if necessary

Tab. 356: Event 84 – Causes and actions

### 19.1.7.46 Event 85: Excessive jump in reference value

The drive controller is interrupted if:

- A29 = 0: Inactive for Drive Based device controller  
or
- A540 = 0: Disable drive motor coasting for CiA 402 device controller

Response:

- The power unit is disabled and axis movement is no longer controlled by the drive controller
- The brakes are applied in the event of an inactive release override (F06)

The drive controller has a fault and a quick stop occurs if:

- A29 = 1: Active for Drive Based device controller  
or
- A540 = 2: Slow down on quick stop ramp for CiA 402 device controller

Response:

- The axis is stopped by a quick stop; meanwhile, the brakes remain released
- At the end of the quick stop, the power unit is disabled and the axis movement is no longer controlled by the drive controller; the brakes engage if release override is inactive (F06)

Cause		Check and action
1: Position	Fast set position change leads to acceleration that cannot be performed	Check the current set acceleration against the maximum permitted acceleration in the drive controller (E64, E69) and reduce the set value change in the controller or change the motor type if necessary
2: Velocity	Fast set velocity change leads to acceleration that cannot be performed	Check the current set acceleration against the maximum permitted acceleration in the drive controller (E64, E69) and reduce the set value change in the controller or change the motor type if necessary

Tab. 357: Event 85 – Causes and actions



### 19.1.7.47 Event 88: Control panel

The drive controller is interrupted if:

- A29 = 0: Inactive for Drive Based device controller  
or
- A540 = 0: Disable drive motor coasting for CiA 402 device controller

Response:

- The power unit is disabled and axis movement is no longer controlled by the drive controller
- The brakes are applied in the event of an inactive release override (F06)

The drive controller has a fault and a quick stop occurs if:

- A29 = 1: Active for Drive Based device controller  
or
- A540 = 2: Slow down on quick stop ramp for CiA 402 device controller

Response:

- The axis is stopped by a quick stop; meanwhile, the brakes remain released
- At the end of the quick stop, the power unit is disabled and the axis movement is no longer controlled by the drive controller; the brakes engage if release override is inactive (F06)

Cause	Check and action
Commissioning and parameterization computer heavily loaded	Check the number of open windows (DS6) and the number of active programs and reduce the number if necessary
Connection error	Check the connection and correct it if necessary
Defective network cable	Check the cable and replace it if necessary
Faulty network connection	Check the network settings and, if applicable, the switch, router or wireless connections and correct them or contact your network service provider if necessary

Tab. 358: Event 88 – Causes and actions

### 19.1.7.48 Event 90: Motion block

The drive controller is interrupted if:

- A29 = 0: Inactive for Drive Based device control

Response:

- The power unit is disabled and axis movement is no longer controlled by the drive controller
- The brakes are applied in the event of an inactive release override (F06)

The drive controller has a fault and a quick stop occurs if:

- A29 = 1: Active for Drive Based device control

Response:

- The axis is stopped by a quick stop; meanwhile, the brakes remain released
- At the end of the quick stop, the power unit is disabled and the axis movement is no longer controlled by the drive controller; the brakes engage if release override is inactive (F06)

Cause		Check and action
1: Next motion block missing	Subsequent motion block for motion block with final velocity is missing	Define buffered subsequent motion block
2: Target Position in reverse direction	Set position is in the opposite direction	A change of travel direction by the subsequent motion block is not permitted for motion blocks with final velocity; adjust the set position
	Set position cannot be reached without reversing	Check limiting values for velocity, deceleration and jerk and adjust if necessary

Tab. 359: Event 90 – Causes and actions

## 19.2 SE6 safety module

In case of a fault, the two diagnostic parameters S02 and S03 supply detailed information about the type of fault or the corresponding cause using error codes.

### 19.2.1 Parameters

The following diagnostic parameters are significant for safety technology in combination with the SE6 safety module.

#### 19.2.1.1 S02 | Safety module SE6 active error code channel A | SD6 | V2

Error code for channel A of the safety module.

Format: AABCCDE hex;

AA = event (offset), BB = cause (index), CC = instance, D = level (error class), E = active error and channel

- Event (offset)
  - Safety function violated  
01 hex = SS1; 02 hex = SS2; 03 hex = SOS; 04 hex = SLI/SLP/SLS/SLT; 05 hex = SSR/STR; 06 hex = SDI; 07 hex = SBT; 08 hex = SBC
  - General  
11 hex = timing; 12 hex = current plausibility check; 13 hex = position plausibility check; 14 hex = parameter plausibility check; 15 hex = safety configuration; 16 hex = data comparison; 17 hex = synchronization; 19 hex = hardware; 1A hex = interface; 1B hex = sequence control; 1C hex = device start-up test; 1D hex = cyclical test; 1E hex = self-test; 1F hex = module data; 20 hex = software
- Cause (index)
- Instance for safety functions with multiple configurations  
Number = instance number
- Level (error class)  
1 hex = error; 2 hex = warning; 3 hex = message; 4 hex = limit; 8 hex = fatal error
- Active error and channel  
0 hex = no error; 1 hex = active error; 2 hex = channel A; 4 hex = channel B

### 19.2.1.2 S03 | Error code channel B | SD6 | V1

Error code for channel B of the safety module.

Format: AABCCDE hex;

AA = event (offset), BB = cause (index), CC = instance, D = level (error class), E = active error and channel

- Event (offset)
  - Safety function violated  
01 hex = SS1; 02 hex = SS2; 03 hex = SOS; 04 hex = SLI/SLP/SLS/SLT; 05 hex = SSR/STR; 06 hex = SDI; 07 hex = SBT;  
08 hex = SBC
  - General  
11 hex = timing; 12 hex = current plausibility check; 13 hex = position plausibility check; 14 hex = parameter plausibility check; 15 hex = safety configuration; 16 hex = data comparison; 17 hex = synchronization; 19 hex = hardware; 1A hex = interface; 1B hex = sequence control; 1C hex = device start-up test; 1D hex = cyclical test; 1E hex = self-test; 1F hex = module data; 20 hex = software
- Cause (index)
- Instance for safety functions with multiple configurations  
Number = instance number
- Level (error class)  
1 hex = error; 2 hex = warning; 3 hex = message; 4 hex = limit; 8 hex = fatal error
- Active error and channel  
0 hex = no error; 1 hex = active error; 2 hex = channel A; 4 hex = channel B

## 19.2.2 Error codes

The code specified in column 1 corresponds to the first four digits of the error code.

Code	Cause	Check and action
0101 hex	SS1 – Limit value violation of configured brake ramp monitoring	Check configured position error for brake ramp monitoring
0201 hex	SS2 – Limit value violation of configured standstill monitoring	<ul style="list-style-type: none"> <li>Check configured position window for standstill</li> <li>Prevent movements if SOS is active</li> </ul>
0202 hex	SS2 – Limit value violation of configured brake ramp monitoring	Check configured position error for brake ramp monitoring
0301 hex	SOS – Limit value violation of configured standstill monitoring	<ul style="list-style-type: none"> <li>Check configured position window for standstill</li> <li>Prevent movements if SOS is active</li> </ul>
0401 hex	SLS – Limit value violation of configured velocity or tolerance range (tolerance time)	<ul style="list-style-type: none"> <li>Check configured limit value of velocity and tolerance time (t1)</li> <li>Ensure that the current velocity of the axis does not exceed the limit value</li> </ul>
0402 hex	SLS – Limit value violation of configured tolerance range (tolerance period)	<ul style="list-style-type: none"> <li>Check configured tolerance period (t2)</li> <li>Ensure that the current velocity of the axis does not exceed the tolerance time</li> </ul>
0403 hex	SLS – Limit value violation of the configured tolerance range (tolerance window)	<ul style="list-style-type: none"> <li>Check configured tolerance window (tolwin)</li> <li>Ensure that the current velocity of the axis does not exceed the tolerance window</li> </ul>
0406 hex	SLI – Limit value violation of the increment	<ul style="list-style-type: none"> <li>Check configured lower and upper position limit</li> <li>Ensure that the increment of the motor does not exceed the limit value</li> </ul>
0408 hex	SLP – Limit value violation of configured position range	<ul style="list-style-type: none"> <li>Check configured lower and upper position limit</li> <li>Check the absolute position of the motor</li> </ul>
0501 hex	SSR – Limit value violation of configured velocity range or tolerance range (tolerance time)	<ul style="list-style-type: none"> <li>Check configured lower and upper velocity limit or tolerance time (t1)</li> <li>Ensure that the current velocity of the axis does not leave the defined velocity range</li> </ul>
0502 hex	SSR – Limit value violation of configured tolerance range (tolerance period)	Check configured tolerance period (t2)
0503 hex	SSR – Limit value violation of configured tolerance range (tolerance window)	Check configured tolerance window (tolwin)
0601 hex	SDI – Limit value violation of direction of motion (positive)	<ul style="list-style-type: none"> <li>Check the motor's direction of motion</li> <li>Monitor the desired direction of motion</li> <li>Check configured window of standstill position</li> </ul>

Code	Cause	Check and action
0602 hex	SDI – Limit value violation of direction of motion (negative)	<ul style="list-style-type: none"> <li>Check the motor's direction of motion</li> <li>Monitor the desired direction of motion</li> <li>Check configured window of standstill position</li> </ul>
0701 hex	SBT – Limit value violation of standstill position BD1/BD2 (brake 1)	<ul style="list-style-type: none"> <li>Ensure that the brake is functioning properly</li> <li>Ensure that the test current is set correctly</li> </ul>
0702 hex	SBT – Limit value violation of standstill position SBC+/- (brake 2)	<ul style="list-style-type: none"> <li>Ensure that the brake is functioning properly</li> <li>Ensure that the test current is set correctly</li> </ul>
0703 hex	SBT – Limit value violation of standstill position (e.g. wait time)	<ul style="list-style-type: none"> <li>Ensure that the brakes are wired properly</li> <li>Ensure that the brakes are functioning properly</li> <li>Ensure that the drive controller engages its brake as expected</li> </ul>
0704 hex	SBT – Limit value violation of configured test current within the test step	<ul style="list-style-type: none"> <li>Ensure that the wiring of the motor is free from errors</li> <li>Check drive controller settings (e.g. parameter for current and velocity control)</li> </ul>
0705 hex	SBT – Faulty brake state	<ul style="list-style-type: none"> <li>Ensure that the brakes are wired properly</li> <li>Check settings of SBC function and brake test</li> <li>Check drive controller settings (e.g. parameter for current and velocity control)</li> </ul>
0706 hex	SBT – Brake test cancellation	Carry out brake test again
0707 hex	SBT – Brake test cancellation by the drive controller	<ul style="list-style-type: none"> <li>Carry out brake test again</li> <li>Check drive controller settings (e.g. parameter for current and velocity control)</li> </ul>
0708 hex	SBT – Timeout of configured test period	<ul style="list-style-type: none"> <li>Check test period and tolerance time</li> <li>Carry out brake test</li> </ul>
0709 hex	SBT – Timeout of configured total time	<ul style="list-style-type: none"> <li>Check configuration of brake test</li> <li>Check drive controller settings (e.g. parameter for current and velocity control)</li> </ul>
070A hex	SBT – Timeout in communication with the drive controller	<ul style="list-style-type: none"> <li>Check configuration of brake test</li> <li>Check drive controller settings (e.g. parameter for current and velocity control)</li> </ul>
070B hex	SBT – Brake test not configured	Check settings of brake test for activated test steps
0801 hex	SBC – Timeout of configured time in feedback control	<ul style="list-style-type: none"> <li>Check configured delay time ON (Ton), OFF (Toff) of feedback control</li> <li>Check correct connection of brake output and feedback signal</li> </ul>

Code	Cause	Check and action
0802 hex	SBC – Faulty feedback status	<ul style="list-style-type: none"> <li>▪ Check settings of SBC safety function for correct type (1: normally open (N/O), 2: normally closed (N/C))</li> <li>▪ Check correct connection of brake output and feedback signal</li> </ul>
1201 hex	Error in the plausibility check of the motor encoder due to current signal	<ul style="list-style-type: none"> <li>▪ Check reactive current settings</li> <li>▪ Check drive controller settings (e.g. parameter for current and velocity control)</li> <li>▪ Check the system for possible interference frequencies (power supply unit, transformer, etc.) and for correct shielding</li> <li>▪ Prevent external influences on the system that may result in adjustment of the motor, for example, and thus current peaks</li> <li>▪ Check motor encoder for proper function</li> </ul>
1202 hex	Error in the plausibility check of the motor encoder due to current signal	<ul style="list-style-type: none"> <li>▪ Check reactive current settings</li> <li>▪ Check drive controller settings (e.g. parameter for current and velocity control)</li> <li>▪ Check the system for possible interference frequencies (power supply unit, transformer, etc.) and for correct shielding</li> <li>▪ Prevent external influences on the system that may result in adjustment of the motor, for example, and thus current peaks</li> <li>▪ Check motor encoder for proper function</li> </ul>
1203 hex	Error in the plausibility check of the motor encoder due to current signal (direction of motion)	<ul style="list-style-type: none"> <li>▪ Check drive controller settings (e.g. parameter for current and velocity control)</li> <li>▪ Check settings of motion and acceleration profiles (change of direction of motion may be too fast)</li> <li>▪ Check motor encoder for proper function</li> </ul>
1301 hex	Error in the plausibility check of external encoder	Check settings and function of the external encoder
1303 hex	Error in the plausibility check of velocity	<ul style="list-style-type: none"> <li>▪ Check settings of the safety module (motor, encoder, etc.)</li> <li>▪ Check motor encoder for proper function</li> </ul>
1305 hex	Error in the plausibility check of external encoder	Check settings and function of the external encoder
1306 hex	Error in the plausibility check of the set velocity value (different sign)	Check settings of the drive controller and safety module
1307 hex	Error in the plausibility check of the set velocity value (position too large)	Check settings of the drive controller and safety module

Code	Cause	Check and action
1308 hex	Error in the plausibility check of external encoder velocity	<ul style="list-style-type: none"> <li>Check settings and function of the external encoder</li> <li>Check settings of the safety module (motor, encoder, etc.)</li> </ul>
1309 hex	Error in the plausibility check of external encoder absolute position	<ul style="list-style-type: none"> <li>Check settings and function of the external encoder</li> <li>Check settings of the safety module (motor, encoder, etc.)</li> </ul>
1401 hex	No match for number of poles	Check number of poles in the configuration of the safety module and drive controller
1402 hex	No match for motor type	Check motor type in the configuration of the safety module and drive controller
1403 hex	No match for motor brake	Check settings of the brake of the safety module and drive controller
1504 hex	Faulty configuration file; parameter specification missing	<ul style="list-style-type: none"> <li>Check safety configuration</li> <li>Download configuration again</li> </ul>
1505 hex	Faulty configuration file; parameter specification invalid	<ul style="list-style-type: none"> <li>Check safety configuration</li> <li>Download configuration again</li> </ul>
1506 hex	Faulty configuration file; parameter check fails	<ul style="list-style-type: none"> <li>Check safety configuration</li> <li>Download configuration again</li> </ul>
1507 hex	Faulty configuration file; invalid number of safety functions	<ul style="list-style-type: none"> <li>Check safety configuration and only use the maximum specified number of respective safety function</li> <li>Download configuration again</li> </ul>
1508 hex	Faulty configuration file; maximum number of safety functions exceeded	<ul style="list-style-type: none"> <li>Check safety configuration and only use the maximum specified number of safety functions</li> <li>Download configuration again</li> </ul>
1509 hex	Faulty configuration file; parameter check fails	<ul style="list-style-type: none"> <li>Check safety configuration</li> <li>Download configuration again</li> </ul>
150B hex	Timeout when downloading the configuration file	<ul style="list-style-type: none"> <li>Check safety configuration</li> <li>Download configuration again</li> </ul>
1512 hex	Device replacement failed	Perform process again and proceed exactly according to instructions
1513 hex	Timeout for device replacement; confirmation by user not entered in time	Perform process again and confirm the device replacement within the specified time
1514 hex	Faulty user input during device replacement	Perform process again and proceed exactly according to instructions
1515 hex	Cancellation of device replacement during user confirmation	Perform process again and do not cancel the device replacement
1601 hex	A subsequent fault has occurred	Rectify error which occurred first
1607 hex	Incorrect material or serial number	<ul style="list-style-type: none"> <li>Carry out download again</li> <li>Check material and serial number</li> </ul>
160A hex	Error when starting the safety module	Restart



Code	Cause	Check and action
1704 hex	Faulty synchronization with drive controller	Check whether the valid, appropriate drive controller firmware is present (E52[3])
1D01 hex	Error in a digital input	<ul style="list-style-type: none"> <li>Ensure that the connection wiring of the input is free from errors</li> </ul>
1D02 hex	Error in a digital output	<ul style="list-style-type: none"> <li>Ensure that there is no short circuit, cross-circuit fault or wire break in the connecting wiring of the output</li> <li>Restart</li> </ul>
1D03 hex	Error when reading back a digital output	Ensure that there is no short circuit, cross-circuit fault or wire break in the connecting wiring of the output
1D04 hex	Error in an SBC output	Ensure that there is no short circuit, cross-circuit fault or wire break in the connecting wiring of the output
1D05 hex	Error when reading back an SBC output	Ensure that there is no short circuit, cross-circuit fault or wire break in the connecting wiring of the output
1D06 hex	Faulty supply voltage	Check supply voltage of the safety module
1D07 hex	Faulty supply voltage	Check supply voltage of the safety module
1D08 hex	Supply voltage of digital outputs is not present	Check supply voltage of the outputs
1D09 hex	Error when testing the supply voltage for digital outputs	Check supply voltage of the outputs
1D0A hex	Faulty supply voltage	Check supply voltage of the safety module
1D0C hex	Faulty supply voltage	Check supply voltage of the safety module

Tab. 360: Error list of the SE6 safety module

## 19.3 Acknowledging faults

There are several options for acknowledging faults. As a rule, an acknowledgement is also transmitted to the safety module.

### Application-independent

Independent of the application, you can acknowledge faults directly on the drive controller using the [ESC] key or alternatively in DriveControlSuite using the control panels.

### Drive Based application

In the Drive Based application, the following options for acknowledging are available in DriveControlSuite:

- By defining the source of the signal in A61 (source: digital input or control byte A180, bit 1)
- By enabling the drive controller via F75 (source for relay 1, terminal X1) and/or using an additional enable signal via A60 (source: digital input or control byte A180, bit 0)

The drive controller has a configurable restart (A34) in the Drive Based application.

### WARNING!

#### Injury to persons and material damage due to unexpected motor startup!

Only activate autostart if the standards and regulations applicable to the system or machine in question permit a direct switch to the Operation enabled device state.

- In accordance with EN 61800-5-1, clearly mark an activated autostart on the system and in the associated system documentation.

### CiA 402 application

In the CiA 402 application, you can acknowledge faults in DriveControlSuite using control word A515, bit 3 (Enable operation) or bit 7 (Fault reset).

### Information on expanded safety technology

The control unit of the drive controller can also send an acknowledgement exclusively to the SE6 safety module without acknowledging its own fault.

The source (digital input or control byte A180, bit 1) is defined in S31 independent of the application. The reaction of the safety module to an acknowledgement by the drive controller is set in PASmotion:

- NOP: No reaction
- ACK ERR: Error acknowledgement without restart of the safety module
- RESTART: Error acknowledgement with restart of the safety module

## 20 Analysis

Scope and multi-axis scope in DriveControlSuite are two analysis tools that help you commission single axes or entire machines and troubleshoot.

You can select and record up to 12 parameters from the entire pool of drive controller parameters. The sampling time can be set from 250  $\mu$ s to several seconds to be able to observe both highly dynamic as well as very slow processes. Like for an actual oscilloscope, there are a variety of trigger options and many statistical evaluation functions for the recorded data (minimum value, maximum value, average, RMS value, standard deviation, etc.).

Tool	Objectives	Application cases
Scope	Create multiple scope images of a single drive controller at different times.	Optimize or diagnose a drive controller
	Create multiple scope images with the same settings (channels, trigger, pre-trigger, sampling time), but differing values for individual parameters.	
	Combine multiple scope images for the analysis.	
	Create a temporary direct image.	
Multi-axis scope	Create individual scope images of multiple drive controllers or axes at the same time.	Check the machine utilization or diagnosis in synchronous operation
	Create an individual scope image with the same settings or individual settings (for each axis or for individual axes).	

Tab. 361: Application cases for scope and multi-axis scope

## 20.1 Scope and multi-axis scope

With the Scope and Multi-axis scope windows, you can create scope images for diagnostic purposes for one or more drive controllers if an online connection is established.

**Information**

The Scope window can be reached using the button in the project menu if you have selected a drive controller in the project tree.

The Multi-axis scope window can be reached using the button in the project menu if you have selected the project in the project tree.

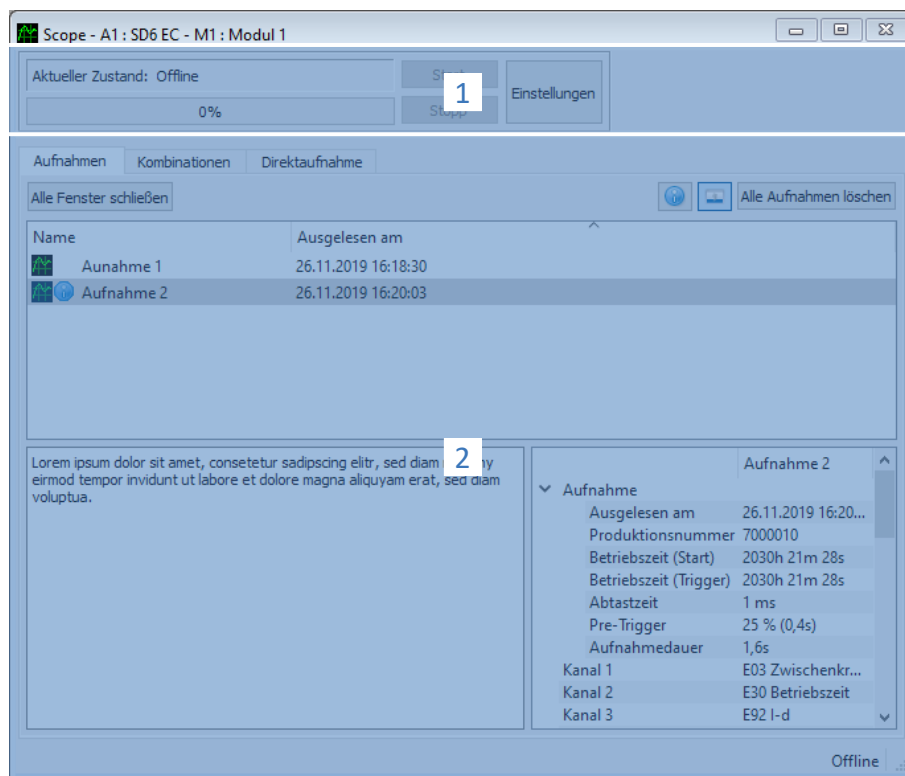



Fig. 93: Scope and multi-axis scope: Program interface

No.	Area	Description
1	Action area	In the Action area, you can define settings for the scope image, start and stop the scope image, and read information on the status, scope image progress and remaining recording time.
2	Scope images	In the Images area, you can open, delete, rename, comment on or export scope images that have already been read out. In the scope, the Combinations and Direct image tabs are also available in this area.

**Action area: Buttons**

Button	Availability	Description
Start	Scope, multi-axis scope	Starts the scope image (prerequisite: online connection).
Stop	Scope, multi-axis scope	Stops the scope image (prerequisite: online connection).
Settings	Scope, multi-axis scope	Opens the <b>Settings</b> window where you can define the trigger condition, channel assignment, sampling time and, in the case of the multi-axis scope, the nodes for the scope image.

**Scope images: Buttons**

Icon	Description
	Opens the dialog box for storing a comment for the scope image.
	Shows/hides the bottom margin area.

**Information**

If you want to learn more about a particular scope image, click on it. Any comments and the properties of the scope image are then displayed at the bottom of the window. You can show the lower margin area using the button in the **Scope images** or **Combinations** tab.

Button	Description
Close all windows	Closes all open scope images and combinations.
Delete all scope images	Deletes all individual scope images; combined scope images are retained (tab: <b>Scope images</b> ).
Delete all combinations	Deletes all combined scope images; individual scope images are retained (tab: <b>Combinations</b> ).

**Scope images: Context menus**

Tab	Availability	Description	Context menu
Scope images	Scope	On the Images tab, completed scope images are listed after being read out from the drive controller. Double-click to open the scope image. If you have created multiple scope images and select this, you can combine and open them via the context menu.	<ul style="list-style-type: none"> <li>▪ Open</li> <li>▪ Delete</li> <li>▪ Rename</li> <li>▪ Comment</li> <li>▪ Export</li> <li>▪ Combine and open</li> </ul>
	Multi-axis scope	On the Images tab, completed scope images are listed after being read out from the drive controller. Double-click to open the scope image.	<ul style="list-style-type: none"> <li>▪ Open</li> <li>▪ Delete</li> <li>▪ Rename</li> <li>▪ Comment</li> <li>▪ Export</li> </ul>
Combinations	Scope	On the Combinations tab, combined scope images are listed that you can open by double-clicking.	<ul style="list-style-type: none"> <li>▪ Open</li> <li>▪ Delete</li> <li>▪ Rename</li> <li>▪ Comment</li> <li>▪ Export</li> </ul>
Direct image	Scope	In the Direct image tab, you can create a temporary scope image that is discarded with the start of the next scope image and use the set value generation to optimize the control cascade.	—

## 20.1.1 Scope settings

In the Settings window, you define the settings for the scope image and the trigger before you start the scope image. The scope image settings are shown in the Channel assignment tab, the trigger settings in the Trigger condition tab (scope) or Node and trigger condition tab (multi-axis scope).

### Information

The Settings window for scope images can be reached via the Settings button in the Scope or Multi-axis scope window.

Tab	Availability	Description
Channel assignment	Scope, multi-axis scope	With the scope image settings in the Channel assignment tab, you define which data of the respective axis you want to record in the scope image, in which time intervals the data is sampled and which time period is recorded before triggering the trigger.
Trigger condition	Scope	With the trigger settings in the Trigger condition tab, you define which event triggers the recording of a scope image.
Node and trigger condition	Multi-axis scope	With the trigger settings in the Node and trigger condition tab, you define which event triggers the recording of a scope image and for which axes a scope image is recorded.

### Example: Trigger and scope image settings

Settings	Example	Results
Trigger settings	<ul style="list-style-type: none"> <li>▪ Simple trigger</li> <li>▪ Source: E15 v-motor-encoder</li> <li>▪ Condition: greater</li> <li>▪ Comparison value: 50 rpm</li> </ul>	The trigger condition is met if the value of parameter E15 v-motor-encoder is greater than 50 rpm.
Scope image settings	<ul style="list-style-type: none"> <li>▪ Recorded channels: 1</li> <li>▪ Sampling time: 1 ms</li> <li>▪ Pre-trigger: 33%</li> </ul>	The recording time calculated from the number of channels and the sampling time is 6.6 s. 2.2 s (33%) are recorded before the trigger is triggered and 4.4 s afterwards.

### Information

Additional settings for your scope images can be made using parameters T25 Automatic start and T26 Retrigger scope.

### 20.1.1.1 Trigger settings

With the trigger settings in the *Trigger condition* tab (scope) or *Node and trigger condition* tab (multi-axis scope), you define which event triggers the recording of a scope image. To do this, define the trigger for each axis and, if applicable, the trigger condition. The selection of the trigger influences which of the settings described below are available to you.

**Information**

The *Settings* window for the scope image can be reached via the *Settings* button in the *Scope* or *Multi-axis scope* window. For the scope, you can find the trigger settings directly in the *Trigger condition* tab. For the multi-axis scope, you can reach the trigger settings for the respective axis via the *Settings* button in the *Node and trigger condition* tab.

Trigger	Description
Manually at stop	The trigger is triggered by the <i>Stop</i> button, without taking the pre-trigger time into account.
Immediately at start	The trigger is triggered by the <i>Start</i> button as soon as the pre-trigger time has elapsed.
Simple trigger	The trigger is triggered automatically when the trigger condition is met and the pre-trigger time has elapsed.
Trigger logic	The trigger is triggered automatically when the trigger logic is satisfied and the pre-trigger time has elapsed.

#### Trigger conditions

A simple trigger consists of a single trigger condition, while trigger logic is composed of 2 trigger conditions logically linked by an operator. A trigger condition consists of the source, the condition and the comparison value.

Source	Description
Inactive	Default value if <i>Manually at stop</i> was selected as the trigger.
Immediately at start	Default value if <i>Immediately at stop</i> was selected as the trigger.
Parameter	Defines a parameter as the source for the trigger. You can enter the parameter either via ... and the <i>Add parameter</i> dialog box or directly into the text field with auto-completion by specifying the coordinate, name and, if applicable, axis number (example: 1.I80 Current position).
Signal name	Defines a signal as the source for the trigger. You have assigned a signal name for this signal in the graphical programming at the input or output of a block. If you have not yet assigned a signal name in the graphical programming, the list is empty.
Physical address	Defines a physical address in the drive controller memory as the source for the trigger. Physical addresses can be assigned as part of an extended diagnosis by the STOBER development team. They must be specified with the associated data type.



Setting	Description
Condition	Condition for the trigger condition with which the source and the comparison value are compared. <ul style="list-style-type: none"> <li>▪ less than</li> <li>▪ less than or equal to</li> <li>▪ greater than</li> <li>▪ greater than or equal to</li> <li>▪ equal to</li> <li>▪ not equal to</li> </ul>
Comparison value	Comparison value for the trigger condition that is compared to the source.
Minimum time	Time, in $\mu\text{s}$ , in which the condition must at least be met for the trigger condition to be considered met.

Option	Description
Absolute value	The Absolute value option enables you to ignore the sign when comparing the source and comparison value.
Mask	The Mask option allows you to evaluate only a single bit of the source.
Edge	The Edge option activates/deactivates edge detection.

Operator	Description
AND	The trigger logic is satisfied if <b>both</b> trigger conditions are met.
OR	The trigger logic is satisfied if <b>one or both</b> trigger conditions are met.
XOR	The trigger logic is satisfied if <b>one</b> of the two trigger conditions is met, <b>not both</b> .
NAND	The trigger logic is satisfied if <b>neither or one</b> of the two trigger conditions is met, <b>not both</b> .
NOR	The trigger logic is satisfied if <b>neither</b> of the two trigger conditions is satisfied.
XNOR	The trigger logic is satisfied if <b>neither or both</b> of the two trigger conditions are met.
Trigger 1	The trigger logic is satisfied if <b>the first</b> trigger condition is met.
Trigger 2	The trigger logic is satisfied if <b>the second</b> trigger condition is met.

Button	Description
Export	Exports all settings (trigger and scope image settings) to a text file (*.txt).
Import	Imports all settings from a text file (*.txt).
Close	Closes the window. All settings are accepted.

### Information

Export your settings if you want to reuse the same or similar settings in other projects or import existing settings and adjust them as necessary.

### 20.1.1.2 Scope image settings

With the scope image settings in the Channel assignment tab, you define which data of the respective axis you want to record in the scope image, in which time intervals the data is sampled and which time period is recorded before triggering the trigger. To do this, define the channel assignment, the sampling time and the pre-trigger for each axis.

**Information**

The Settings window for the scope image can be reached via the Settings button in the Scope or Multi-axis scope window. For the scope and multi-axis scope, the scope image settings are shown in the Channel assignment tab.

**Information**

For a multi-axis scope, you must first select at least 2 nodes before you can specify the settings in the Channel assignment tab. You can specify identical channel assignments for all axes or use the Individual option to store differing settings for each axis. The calculation of the recording time and pre-trigger time relate to the axis with the shortest recording time.

Setting	Selection	Description
Channel assignment	Inactive	When Inactive is selected, no value is recorded in the scope image for the channel.
	Parameters	When Parameter is selected, the value of a parameter is recorded in the scope image for the channel.
	Signal names	When Signal name is selected, the value of a signal is recorded in the scope image for the channel. You defined a signal name for this signal in the graphic programming at the input or output of a block.
	Physical address	When Physical address is selected, the value of a physical address in the memory of the drive controller is recorded in the scope image for the channel.
Sampling time	250 µs - 100 ms	With the Sampling time setting, you define the time interval in which the signals are sampled for the scope image.
Pre-trigger	0 % – 100 %	With the Pre-Trigger setting, you define the percentage of the scope memory that must be occupied for the axis to be trigger-ready and thus the percentage of the recording time before the trigger.

**Information**

The scope memory has approximately 32 KB available for the scope image. The recording time is calculated from the sampling time, the number of recorded channels and the available disk space. The larger the number of recorded channels and the more frequently the channels are sampled, the faster the available disk space is occupied and the shorter the scope image becomes.

The pre-trigger time is calculated from the set pre-trigger and the recording time.

**Information**

If a large pre-trigger value is entered with a long recording time, the scope image may remain in the Started state for a period after the start until the pre-trigger is fulfilled and recording readiness is signaled by the Trigger-ready state. Status and progress of the scope image are displayed in DriveControlSuite. The scope image is then read out from the drive controller and transmitted to DriveControlSuite.

Button	Description
Export	Exports all settings (trigger and scope image settings) to a text file (*.txt).
Import	Imports all settings from a text file (*.txt).
Close	Closes the window. All settings are accepted.

### Information

Export your settings if you want to reuse the same or similar settings in other projects or import existing settings and adjust them as necessary.

## 20.1.2 Image editor

The image editor contains all the functions you need to edit your scope images.

**Information**

The image editor can be reached by double-clicking a scope image or via the context menu of the respective scope image.

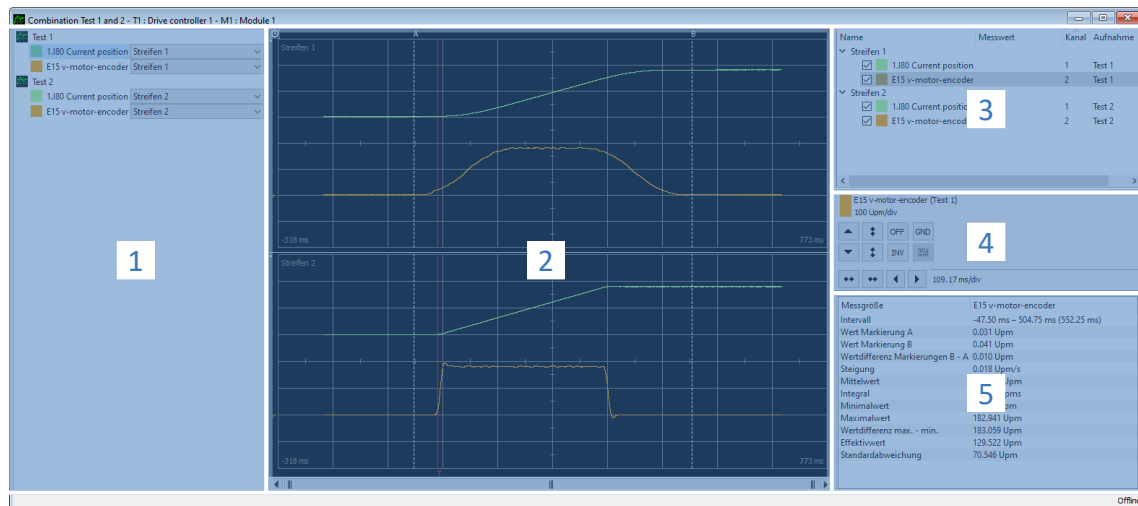

Fig. 94: Scope and multi-axis scope: Image editor



No.	Area	Description
1	Assignment of channel to band	For combinations or multi-axis scope images, you can change the assignment to a section within the scope image (= band) for each channel in the Channels and bands area.
2	Scope image	In the Scope image area, you see the graphical representation of the recorded and visible channels.
3	Channel selection	In the Channel selection area, you manage the bands and channels of a scope image.
4	Channel settings	In the Channel settings area, you can adjust the graphical representation of the channels.
5	Measured values	In the Measured values area, values for different measured variables are output with measuring points A and B for the selected channel. For scope images, there is also the option to carry out a frequency analysis.



### Assignment of channel to band

This area is only available in case of combinations or multi-axis scope images. By default, each scope image is assigned a band with the recorded channels. You can hide each channel (parameter, signal name or physical address) or change the assignment to a band via the corresponding picklist. However, new bands must be created beforehand in the Channel selection area.

### Scope image

A scope image shows a graphical representation of the recorded and visible channels.

Icon/Button	Description	Context menu
	Left-clicking on measuring line A or B allows the line to be shifted to the left or right as desired.	—
[Right mouse button]	Right-clicking on any point of the scope image opens the context menu.	<ul style="list-style-type: none"> <li>▪ Set marking A here</li> <li>▪ Set marking B here</li> <li>▪ Jump to marking A</li> <li>▪ Jump to marking B</li> </ul>
[Left mouse button]	Left-clicking on any point of the scope image activates the quick measurement. The values are output in the Channel selection area in the Measured value column.	—
	Marking the zero line of a channel.	—
	Marking the trigger line.	—

Icon	Description
	Opens the image editor settings for the coloring of the drawing area and channels.
	Opens the dialog box for storing a comment for the scope image.
	Opens the list of scope images in order to take over the channel scaling from a scope image that has already been adjusted. Button only available for scope images, not for combinations or multi-axis scope images.













### Channel selection

In the Channel selection area, you manage the bands and the channels assigned to them. You can delete existing bands or create new bands. You can activate or deactivate the display of a channel. For each channel, a channel number and the name of the scope image is output. If you click any point within the scope image, the associated measured value is also displayed.

Element	Description	Context menu
Band	Section of a scope image	<ul style="list-style-type: none"> <li>▪ Delete band</li> <li>▪ Create new band</li> </ul>
Channel	Recorded parameter, signal name or physical address	<ul style="list-style-type: none"> <li>▪ Hide channel</li> <li>▪ Only show this channel</li> <li>▪ Show all channels</li> <li>▪ Invert display of channels</li> <li>▪ Create new band</li> </ul>

### Channel settings

The channel settings are used to adjust the graphical representation of the channels and scope image. In the display above the buttons, you see the color, complete designation and scaling of the selected channel. You can use the buttons to change the display of the channel or time axis. In the display next to the button for the time axis, the current scaling of the x-axis is displayed.

Button	Section	Description
	Channel display	Opens the color palette for changing the channel color.
 	Channel settings	Moves the curve of the activated channel up or down by a grid interval: <ul style="list-style-type: none"> <li>▪ [Shift] + [button]: Moves curve up or down by a pixel</li> <li>▪ [Ctrl] + [button]: Moves curve up or down to the next grid line</li> <li>▪ [Shift] + [Ctrl] + [button]: Centers curve vertically</li> </ul>
 		Enlarges or reduces the channel scaling (fixed point = horizontal image center): <ul style="list-style-type: none"> <li>▪ [Shift] + [button]: Autoscaling</li> </ul>
		Displays or hides the channel.
		Inverts the channel display.
		Indicates the zero line of the channel.
		Opens the list of parameter signals for selecting an individual bit. Button can only be used for whole-number parameters without decimal places (BYTE, WORD or DWORD data types), but not for selection parameters.
 	Time axis settings	Enlarges or reduces the scaling of the x-axis: <ul style="list-style-type: none"> <li>▪ [Ctrl] + [button]: Autoscaling</li> </ul>
 		Moves the scope image left or right by a grid interval: <ul style="list-style-type: none"> <li>▪ [Shift] + [button]: Moves scope image left or right by a pixel</li> <li>▪ [Ctrl] + [button]: Moves scope image left or right to the next grid line</li> <li>▪ [Shift] + [Ctrl] + [button]: Centers scope image horizontally</li> </ul>

## Measured values

In the *Measured values* area, values for different measured variables are output with measuring points A and B for the selected channel. For scope images, there is also the option to carry out temporary frequency analyses in the form of a discrete Fourier transform (DFT). When the image editor is closed, DFT calculations are discarded again.

Tab	Availability	Description
Scope	Scope, multi-axis scope	The <i>Scope</i> tab has a list of the values for various variables referring to measuring points A and B for the selected channel.
Frequency analysis	Scope	The <i>Frequency analysis</i> tab can be used for performing Fourier transforms on scope images.

## 20.1.3 Frequency analysis

Between measuring points A and B in the *Frequency analysis* tab of the image editor, a blue transparent window appears for which a discrete Fourier transform can be carried out. Interval and measured values (= number of sensing points between A and B) are displayed for you.

### Information

You can reach the tab where you can carry out a frequency analysis in the image editor of a scope image through the *Measured values area > Frequency analysis tab*.

Setting	Selection	Description
Window function	Hamming	Minimizes the leakage effect for the Fourier transform.
	Without weighting	Calculation without correction.

Button	Description
Calculate DFT	The DFT is calculated and opened in a separate window.

### DFT window

The calculated DFT opens in a separate window. When the window is closed, the calculation is discarded again. You can adjust the display:

- [Ctrl] + [Left mouse button]: Zoom in on section
- [Ctrl] + [Right mouse button]: Reset display to initial value (100%)

Button	Description
OFF	Displays or hides the selected channel.
Log	Logarithmically scales the y- or x-axis.
Lin	Linearly scales the y- or x-axis.

## 20.2 Scope image

Scope image recording is divided into 3 steps:

- Preparation of the scope image in DriveControlSuite
  - Establish online connection
  - Configure channels of the participating axis
  - Define trigger settings
  - Start the recording
- Loading the data in the drive controller
  - Process of trigger communication (independent of DriveControlSuite)
  - Monitoring of recording by DriveControlSuite
- Reading out and displaying the scope image
  - Read the scope image out of the drive controller
  - Display the scope image in DriveControlSuite

### 20.2.1 Creating a scope image

Create a scope image by specifying the scope image and trigger settings. Then start the scope image with an existing online connection.

#### Information

During the search, all drive controllers within the broadcast domain are found via IPv4 limited broadcast.

Requirements for finding a drive controller in the network:

- Network supports IPv4 limited broadcast
- All drive controllers and the PC are in the same subnet (broadcast domain)

#### Establishing an online connection (existing project)

Connect your PC and the drive controller to the network.

- ✓ The drive controller is switched on.
  - ✓ A suitable project file for your drive system already exists.
1. Start DriveControlSuite.
  2. Click on **Open project**.
  3. Navigate to the directory and load the file.
  4. In the project menu, click **Online connection**.
    - ⇒ The **Add connection** window opens. All drive controllers found via IPv4 limited broadcast are displayed.
  5. **Direct connection tab > IP address column**:  
 Activate the IP address in question and confirm your selection with **OK**.
    - ⇒ The **Online functions** window opens. The drive controller that is connected using the previously selected IP address is displayed.
  6. **Online tab**:  
 Click **Set all to read** in order to activate the drive controller for read data synchronization.
  7. Click **Assign all based on reference** to assign the drive controller to the configured drive controller.



8. Then click **Establish online connection**.
  - ⇒ The data connection is established and the project configuration data is compared; if the project configuration data is identical, only the parameter values are transmitted from the drive controller to the PC.
  - ⇒ The drive controller in the project tree is active.

### Optional: Establishing an online connection (new project)

Connect your PC and the drive controller to the network.

- ✓ The drive controller is switched on.
1. Start **DriveControlSuite**.
  2. Click on **Read project**.
    - ⇒ The **Add connection window** opens. All drive controllers found via IPv4 limited broadcast are displayed.
  3. **Direct connection tab > IP address column**:  
Activate the IP address in question and confirm your selection with **OK**.
    - ⇒ The **Online functions window** opens. The drive controller that is connected using the previously selected IP address is displayed.
  4. **Online tab**:  
Click **Set all to read** in order to activate the drive controller for read data synchronization.
  5. Click on **Set all to create new drive controller** to create the new drive controller in the project tree.
  6. Then click **Establish online connection**.
    - ⇒ The data connection is established and the project configuration data is transmitted from the drive controller to the PC.
    - ⇒ The drive controller is created in the project tree and is active.

### Define the settings for scope images and triggers

Define the scope image settings and the trigger settings before you start the scope image.

1. Select the relevant drive controller in the project tree and click **Scope** in the project menu.
  - ⇒ The **Scope window** opens.
2. **Action area**:  
To define the settings for the scope image, click **Settings**.
  - ⇒ The **Settings window** opens.
3. **Trigger condition tab**:  
Define which event triggers the scope image.
  - 3.1. Select **Manual at stop** to activate the trigger via the **Stop button (without pre-trigger)**.
  - 3.2. Select **Immediately at start** to activate the trigger via the **Start button (with pre-trigger)**.
  - 3.3. Select **Simple trigger** to activate the trigger automatically when a trigger condition occurs.
  - 3.4. Select **Trigger logic** to activate the trigger automatically when two logically linked trigger conditions occur.
4. **Trigger condition tab**:  
If you have selected **Simple trigger** or **Trigger logic**, define the **Source**, **Condition** and **Comparison value** for the trigger condition.
  - 4.1. If you have selected **Single trigger**, define the individual trigger condition.
  - 4.2. If you have selected **Trigger logic**, define both trigger conditions and the operator for the logical operation.

5. Channel assignment tab:  
Select which data is to be recorded with the scope image.
  - 5.1. Parameter:  
To record the value of a parameter, enter the coordinate, name and, if applicable, axis number of the parameter with the **Add parameter** dialog box via ... or by writing directly into the text field and using auto-completion (example: 1.I80 Current position).
  - 5.2. Signal name:  
To record the value of a signal, select a signal for which you have assigned a signal name in the graphic programming.
  - 5.3. Physical address:  
To record the value of a physical address in the drive controller memory, select the data type and specify the address.
6. Channel assignment tab, Sampling time selection:  
Select the time interval at which the channel is to be sampled.
7. Channel assignment tab, Pre-trigger selection:  
Define the percentage of the recording time before the trigger.
  - ⇒ The calculated recording time and pre-trigger time are displayed.
8. Confirm your settings with **Close**.

### Creating a scope image

Start the scope image of the data in the drive controller and read out the scope image to DriveControlSuite according to the scope image and trigger settings.

- ✓ You are in the **Scope window**, **Scope images tab**.
- ✓ You have configured the settings for the scope image.
- ✓ There is an online connection between DriveControlSuite and the drive controller.

1. Action area:  
To start the scope image of the data in the drive controller, click **Start**.
    - ⇒ The drive controller records the data in the scope memory in accordance with the scope image settings.
    - ⇒ The **Action area** of DriveControlSuite displays information about the status of the scope image.
  2. Optional: Click **Stop** if you use the **Manually at stop** trigger setting or if you want to stop the scope image early before the recording time expires.
    - ⇒ When the trigger is triggered, DriveControlSuite reads the data from the scope memory according to the scope image settings.
- ⇒ The finished scope image is listed in the **Scope images tab** and can be opened via double-click.

## 20.2.2 Combining scope images

Combine scope images with each other to easily compare the recorded data.

- ✓ You are in the *Scope window*, *Scope images tab*.
  - ✓ You have created multiple scope images for a drive controller.
1. *Scope images tab*:  
Select the scope images you want to combine and choose *Combine and open* from the context menu.
- ⇒ *Combinations tab*:  
The combined scope image is listed in the *Combinations tab* and opens in the image editor.

## 20.2.3 Creating a direct image

Create a scope image by specifying the scope image and trigger settings. Then start the scope image with an existing online connection.

### Information

During the search, all drive controllers within the broadcast domain are found via IPv4 limited broadcast.

Requirements for finding a drive controller in the network:

- Network supports IPv4 limited broadcast
- All drive controllers and the PC are in the same subnet (broadcast domain)

### Establishing an online connection (existing project)

Connect your PC and the drive controller to the network.

- ✓ The drive controller is switched on.
  - ✓ A suitable project file for your drive system already exists.
1. Start *DriveControlSuite*.
  2. Click on *Open project*.
  3. Navigate to the directory and load the file.
  4. In the project menu, click *Online connection*.  
⇒ The *Add connection window* opens. All drive controllers found via IPv4 limited broadcast are displayed.
  5. *Direct connection tab* > *IP address column*:  
Activate the IP address in question and confirm your selection with *OK*.  
⇒ The *Online functions window* opens. The drive controller that is connected using the previously selected IP address is displayed.
  6. *Online tab*:  
Click *Set all to read in order* to activate the drive controller for read data synchronization.
  7. Click *Assign all based on reference* to assign the drive controller to the configured drive controller.
  8. Then click *Establish online connection*.  
⇒ The data connection is established and the project configuration data is compared; if the project configuration data is identical, only the parameter values are transmitted from the drive controller to the PC.  
⇒ The drive controller in the project tree is active.

**Optional: Establishing an online connection (new project)**

Connect your PC and the drive controller to the network.

- ✓ The drive controller is switched on.
- 1. Start DriveControlSuite.
- 2. Click on Read project.
  - ⇒ The Add connection window opens. All drive controllers found via IPv4 limited broadcast are displayed.
- 3. Direct connection tab > IP address column:  
Activate the IP address in question and confirm your selection with OK.
  - ⇒ The Online functions window opens. The drive controller that is connected using the previously selected IP address is displayed.
- 4. Online tab:  
Click Set all to read in order to activate the drive controller for read data synchronization.
- 5. Click on Set all to create new drive controller to create the new drive controller in the project tree.
- 6. Then click Establish online connection.
  - ⇒ The data connection is established and the project configuration data is transmitted from the drive controller to the PC.
  - ⇒ The drive controller is created in the project tree and is active.

## Define the settings for scope images and triggers

Define the scope image settings and the trigger settings before you start the scope image.

1. Select the relevant drive controller in the project tree and click **Scope** in the project menu.  
⇒ The **Scope** window opens.
2. **Action area:**  
To define the settings for the scope image, click **Settings**.  
⇒ The **Settings** window opens.
3. **Trigger condition tab:**  
Define which event triggers the scope image.
  - 3.1. Select **Manual at stop** to activate the trigger via the **Stop** button (without pre-trigger).
  - 3.2. Select **Immediately at start** to activate the trigger via the **Start** button (with pre-trigger).
  - 3.3. Select **Simple trigger** to activate the trigger automatically when a trigger condition occurs.
  - 3.4. Select **Trigger logic** to activate the trigger automatically when two logically linked trigger conditions occur.
4. **Trigger condition tab:**  
If you have selected **Simple trigger** or **Trigger logic**, define the **Source**, **Condition** and **Comparison** value for the trigger condition.
  - 4.1. If you have selected **Single trigger**, define the individual trigger condition.
  - 4.2. If you have selected **Trigger logic**, define both trigger conditions and the operator for the logical operation.
5. **Channel assignment tab:**  
Select which data is to be recorded with the scope image.
  - 5.1. **Parameter:**  
To record the value of a parameter, enter the coordinate, name and, if applicable, axis number of the parameter with the **Add parameter** dialog box via ... or by writing directly into the text field and using auto-completion (example: 1.I80 Current position).
  - 5.2. **Signal name:**  
To record the value of a signal, select a signal for which you have assigned a signal name in the graphic programming.
  - 5.3. **Physical address:**  
To record the value of a physical address in the drive controller memory, select the data type and specify the address.
6. **Channel assignment tab, Sampling time selection:**  
Select the time interval at which the channel is to be sampled.
7. **Channel assignment tab, Pre-trigger selection:**  
Define the percentage of the recording time before the trigger.  
⇒ The calculated recording time and pre-trigger time are displayed.
8. Confirm your settings with **Close**.

## Creating a direct image

Start the scope image of the data in the drive controller and read out the scope image to DriveControlSuite according to the scope image and trigger settings.

- ✓ You are in the *Scope window*, *Direct image tab*.
- ✓ You have configured the settings for the scope image.
- ✓ There is an online connection between DriveControlSuite and the drive controller.

### 1. Action area:

To start the scope image of the data in the drive controller, click *Start*.

- ⇒ The drive controller records the data in the scope memory in accordance with the scope image settings.
- ⇒ The *Action area* of DriveControlSuite displays information about the status of the scope image.

### 2. Optional: Click *Stop* if you use the *Manually at stop* trigger setting or if you want to stop the scope image early before the recording time expires.

- ⇒ When the trigger is triggered, DriveControlSuite reads the data from the scope memory according to the scope image settings.
- ⇒ The finished scope image is displayed in the *Direct image tab*.

## 20.3 Multi-axis scope images

Recording via multi-axis scope is divided into 3 steps:

- Preparation of the scope images in DriveControlSuite
  - Establish online connections
  - Select participating axes and define settings for triggering axes
  - Configure channels of the participating axes
  - Start recording
- Loading of the data in the drive controllers
  - Process of trigger communication (independent of DriveControlSuite)
  - Monitoring of individual recordings by DriveControlSuite
- Reading out and displaying the scope images
  - Read out scope images from the drive controllers
  - Display scope images in DriveControlSuite

### 20.3.1 Prerequisites

To find the participating drive controllers in the network and their communication with each other via broadcast, you must observe the following requirements:

- Network supports IPv4 limited broadcast
- All drive controllers are in the same subnet (broadcast domain)
- All drive controllers are connected to each other by IGB motion bus and connected to the PC with DriveControlSuite commissioning software installed; also see [IGB and IGB motion bus network](#) [▶ 443]
- Optional: An EtherCAT-based controller takes over synchronization of the scope images via distributed clocks

The following graphic shows the basic network structure for multi-axis scope images.

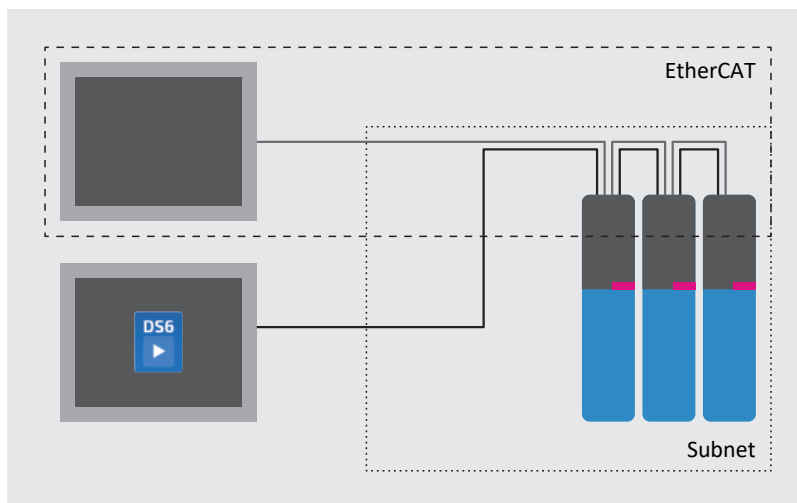

Fig. 95: Multi-axis scope: network structure

## 20.3.2 Creating a multi-axis scope image

Establish an online connection to the participating drive controllers, define the nodes, trigger settings and channels, and then start the recordings.

### Information

During the search, all drive controllers within the broadcast domain are found via IPv4 limited broadcast.

Requirements for finding a drive controller in the network:

- Network supports IPv4 limited broadcast
- All drive controllers and the PC are in the same subnet (broadcast domain)

### Establishing an online connection (existing project)

Connect your PC and the drive controllers to the network.

- ✓ The drive controllers are switched on.
  - ✓ A suitable project file for your drive system already exists.
1. Start DriveControlSuite.
  2. Click on **Open project**.
  3. Navigate to the directory and load the file.
  4. In the project menu, click **Online connection**.
    - ⇒ The **Add connection window** opens. All drive controllers found via IPv4 limited broadcast are displayed.
  5. **Direct connection tab > IP address column**:  
Activate the IP addresses in question and confirm your selection with **OK**.
    - ⇒ The **Online functions window** opens. All drive controllers connected through the previously selected IP addresses are displayed.
  6. **Online tab**:  
Click **Set all to read** in order to activate all drive controllers for read data synchronization.
  7. Click **Assign all based on reference** to assign all drive controllers to the configured drive controllers.
  8. Then click **Establish online connection**.
    - ⇒ The data connection is established and the project configuration data is compared; if the project configuration data is identical, only the parameter values are transmitted from the drive controllers to the PC.
    - ⇒ The drive controllers in the project tree are active.



### Optional: Establishing an online connection (new project)

Connect your PC and the drive controllers to the network.

- ✓ The drive controllers are switched on.
- 1. Start DriveControlSuite.
- 2. Click on Read project.
  - ⇒ The Add connection window opens. All drive controllers found via IPv4 limited broadcast are displayed.
- 3. Direct connection tab > IP address column:  
Activate the IP addresses in question and confirm your selection with OK.
  - ⇒ The Online functions window opens. All drive controllers connected through the previously selected IP addresses are displayed.
- 4. Online tab:  
Click Set all to read in order to activate all drive controllers for read data synchronization.
- 5. Click on Set all to create new drive controller to create the new drive controllers in the project tree.
- 6. Then click Establish online connection.
  - ⇒ The data connection is established and the project configuration data is transmitted from the drive controllers to the PC.
  - ⇒ The drive controllers are created in the project tree and are active.

### Defining nodes and triggering axes

Define which axes are recorded for the multi-axis scope image and which of the axes can trigger the scope image.

1. Select the project in the project tree and click Multi-axis scope in the project menu.
  - ⇒ The Multi-axis scope window opens.
2. Action area:  
To define the settings for the scope image, click Settings.
  - ⇒ The Settings window opens.
3. Node and trigger condition tab, Node column:  
Activate all axes that you want to record with the multi-axis scope image.
4. Node and trigger condition tab, Distribute trigger column:  
Activate all axes for which you want to define a trigger that triggers the scope image for all participating axes.
  - ⇒ The Settings button is displayed for each triggering axis.

#### Information

If you define more than one trigger for a multi-axis scope image, the scope image is triggered for all participating axes as soon as one of the trigger conditions occurs (logical OR operation).

### Define the settings for scope images and triggers

Define the scope image settings and the trigger settings before you start the scope image.

- ✓ You are in the Multi-axis scope window > Settings window.
- 1. Node and trigger condition tab:  
To define the trigger condition, click Settings next to the respective triggering axis.
  - ⇒ The Settings window opens.

2. Node and trigger condition > Settings tab:  
For each triggering axis, define which event triggers the scope image.
  - 2.1. Select Manual at stop to activate the trigger via the Stop button (without pre-trigger).
  - 2.2. Select Immediately at start to activate the trigger via the Start button (with pre-trigger).
  - 2.3. Select Simple trigger to activate the trigger automatically when a trigger condition occurs.
  - 2.4. Select Trigger logic to activate the trigger automatically when two logically linked trigger conditions occur.
3. Node and trigger condition > Settings tab:  
If you have selected Simple trigger or Trigger logic, define the Source, Condition and Comparison value for the trigger condition.
  - 3.1. If you have selected Single trigger, define the individual trigger condition.
  - 3.2. If you have selected Trigger logic, define both trigger conditions and the operator for the logical operation.
4. Confirm your settings with Close.  
⇒ The Settings window closes.
5. Node and trigger condition tab:  
If you have defined more than one triggering axis, repeat the procedure for the remaining triggering axes.
6. Channel assignment tab:  
Select which data is to be recorded with the scope image.
  - 6.1. Parameter:  
To record the value of a parameter, enter the coordinate, name and, if applicable, axis number of the parameter with the Add parameter dialog box via ... or by writing directly into the text field and using auto-completion (example: 1.I80 Current position).
  - 6.2. Signal name:  
To record the value of a signal, select a signal for which you have assigned a signal name in the graphic programming.
  - 6.3. Physical address:  
To record the value of a physical address in the drive controller memory, select the data type and specify the address.
7. Channel assignment tab, Sampling time selection:  
Select the time interval at which the channel is to be sampled.
8. Channel assignment tab, Pre-trigger selection:  
Define the percentage of the recording time before the trigger.  
⇒ The calculated recording time and pre-trigger time are displayed.
9. Confirm your settings with Close.

<b>Information</b>
--------------------

In a multi-axis scope image, you can define per channel whether the same data is recorded for all participating axes or individual data per axis. To do this, activate the Individual option in the Channel assignment tab, click Open settings and define the data to be recorded per participating axis for the respective channel.

### Creating a multi-axis scope image

Start the scope image of the data in the drive controller and read out the scope image to DriveControlSuite according to the scope image and trigger settings.

- ✓ You are in the **Multi-axis scope** window.
  - ✓ You have configured the settings for the scope image.
  - ✓ There is an online connection between DriveControlSuite and the drive controller.
1. Action area:
 

To start the scope image of the data in the drive controller, click **Start**.

    - ⇒ The drive controller records the data in the scope memory in accordance with the scope image settings.
    - ⇒ The Action area of DriveControlSuite displays information about the status of the scope image.
  2. Optional: Click **Stop** if you use the **Manually at stop** trigger setting or if you want to stop the scope image early before the recording time expires.
    - ⇒ When the trigger is triggered, DriveControlSuite reads the data from the scope memory according to the scope image settings.
- ⇒ The finished scope image is listed in the **Scope images** tab and can be opened via double-click.

## 20.4 Parameters

You can use the following parameters to configure additional settings for the scope images.

### 20.4.1 T25 | Automatic start | G6 | V0

Automatically starts scope image recording after the drive controller is restarted.

Scope image is started with the settings that were last saved by the A00 action.

- 0: Inactive
- 1: Active

Double-axis controller: 1.T25 also applies to axis B; 2.T25 has no function.

Prepare the automatic creation of a scope image as described below.

- ✓ You have established an online connection to the drive controller.
1. Select the relevant drive controller in the project tree and click on the button for the selected axis in the project menu > **Parameter list area**.
  2. Group T > Parameters T25 Automatic start:  
Select 1: Active.
  3. Click on **Scope** in the project menu.
    - ⇒ The **Scope** window opens.
  4. Click on **Settings**.
    - ⇒ The **Settings** window opens.
  5. Define the channel assignments and trigger conditions for the scope image, then close the window.
  6. In the **Scope** window, click on **Start** to transmit the settings to the drive controller.
  7. Save the settings in non-volatile memory (A00).
- ⇒ Scope image recording starts automatically after the next restart.

## 20.4.2 T26 | Retrigger scope | G6 | V1

Setting for the scope image.

- 0: Inactive

Scope image is started by the user or once only by restarting the drive controller (T25 = 1: Active).

The completed scope image is temporarily saved in the drive controller and can be read out by the DriveControlSuite (prerequisite: Scope window open).

- 3: Active

Scope serial images are started initially by the user or by restarting the drive controller (T25 = 1: Active).

The completed scope image is temporarily saved in the drive controller and can be read out by the DriveControlSuite (prerequisite: Scope window open).

As long as T26 = 3: Active, the next scope image is triggered automatically after each completed scope image and the previous scope image is overwritten in the drive controller.

## 21 Replacement

The following chapters describe the replacement of a drive controller and the available accessories.

### 21.1 Safety instructions for device replacement

Replacement work is permitted only when no voltage is present. Obey the 5 safety rules (see [Working on the machine](#) [▶ 20]).

When the power supply voltage is turned on, hazardous voltages may be present on the connection terminals and the cables connected to them.

The device and the cables connected to it are not necessarily de-energized when the supply voltage is switched off and all displays have gone out!

#### Information

Note the discharge time of the DC link capacitors in the general technical data for the devices. You can only determine the absence of voltage after this time period.

Protect the devices against falling parts (bits or strands of wire, pieces of metal, etc.) during installation or other work in the control cabinet. Parts with conductive properties may result in a short circuit inside the devices and device failure as a result.

Opening the housing, plugging in or unplugging connection terminals, connecting or removing a connecting wiring, and installing or removing accessories are prohibited while the voltage supply is switched on.

If you couple the drive controllers in the DC link, make sure that all Quick DC-Link modules are built over with a drive controller again after replacement.

The device housing must be closed before you turn on the supply voltage.

### 21.2 Notes on the safety configuration

A drive controller with expanded safety function through the SE6 safety module always requires a valid safety configuration. If this is missing, an error message is generated.

The safety configuration of the safety module has a unique CRC overall checksum which also uses encryption to store the serial number of the safety module. Various safety modules can have identical safety functions despite this. In this case, the CRC checksums match the safety functions.

The safety configuration is saved on the safety module. In addition, a copy of the configuration is saved on the Paramodul. If you replace a drive controller, you can continue using the Paramodul and, as a result, the safety configuration of the drive controller being replaced. For information on how to do this, see [Replacing the drive controller](#) [▶ 414].

The checksums are displayed using parameter S09 Safety modul SE6 checksum of safety configuration. The checksum of the safety functions is output in element 2.

## 21.3 Notes on motor replacement

When replacing a STOBER synchronous servo motor with EnDat encoder and electronic nameplate, the drive controller detects that a motor replacement has been performed upon switching on the drive controller (prerequisite: B04 = 64: Active).

As a response, the drive controller reads out the changed data from the electronic nameplate, transmits this data to the corresponding parameters and reports the process using a fault of type 81: Motor allocation. Based on the cause of the fault, you can recognize what has changed.

In order to take over the changed data onto the Paramodul and thus store it in non-volatile memory, you must carry out the Save values action in parameter A00. As an alternative, save the data using the save button on the display.

Otherwise, the next time the drive controller is switched on, the electronic nameplate is read out again and the changed data is reported using a fault of type 81: Motor allocation.

## 21.4 Replacing the drive controller

### **WARNING!**

#### **Electrical voltage! Risk of fatal injury due to electric shock!**

- Always switch off all power supply voltage before working on the devices!
- Note the discharge time of the DC link capacitors in the general technical data. You can only determine the absence of voltage after this time period.

### **ATTENTION!**

#### **Loss of absolute position!**

The absolute position in the encoder is lost if the encoder cable is disconnected from the AES battery module.

- Do not disconnect the encoder cable from the AES during service work! Disconnect the AES from the drive controller.

### **ATTENTION!**

#### **Damage to property due to electrostatic discharge!**

Take appropriate measures when handling exposed circuit boards, e.g. wearing ESD-safe clothing.

Do not touch contact surfaces.

### **Information**

The safety module is a permanently integrated component in the drive controller where any design, technical and electrical modifications are prohibited!

## Tools and material

You will need:

- Tool for loosening and tightening the fastening screws

## Requirements and replacement

- ✓ Drive controllers of the same series and same power can be replaced interchangeably.
  - ✓ The hardware and firmware of the drive controller being installed have the same or a newer version than the drive controller being replaced. For information on firmware updates, see [Replacing or updating firmware using DS6 \[▶ 417\]](#).
  - ✓ The Paramodul of the drive controller being replaced is present; the original project is stored on the Paramodul.
1. Optional: If an AES battery module is present, disconnect the AES from the drive controller.
  2. Remove all terminals from the drive controller being uninstalled.
  3. Release the grounding conductor from the ground bolt.
  4. Sizes 0 to 2: Unscrew the upper fastening screw slightly and remove the lower one to allow removal of the EM6A0 EMC shroud.
  5. Remove the fastening screws and take the drive controller out of the control cabinet. Note that, if you couple the drive controller to the DC link over Quick DC-Link or you use a rear section braking resistor, you first have to press the drive controller up at the guides before you can remove it from the control cabinet.
  6. Remove the Paramodul of the new drive controller being installed.
  7. Insert the Paramodul with the original project into the drive controller being installed.
  8. Optional: Remove the communication and terminal modules from the drive controller being replaced if no accessories have been provided with the new drive controller.
  9. Optional: Install the accessories into the new drive controller.
  10. Install the new drive controller in the control cabinet.
  11. Connect the grounding conductor to the ground bolt. Obey the instructions and requirements for [Protective grounding \[▶ 142\]](#).
  12. Reattach the terminals.
  13. Optional: If an AES battery module was present, attach it to the drive controller with the associated encoder cable. Tighten the knurled screws so that AES is securely connected to the drive controller.
  14. Start the drive controller.
  15. Optional: If you are using the expanded safety functionality through the SE6 safety module, press the left and right arrow buttons simultaneously for 2 seconds after the corresponding prompt in order to activate the safety functions.
    - ⇒ The transmission of configuration data from the Paramodul starts.
    - ⇒ Data transmission is shown on the display.
    - ⇒ The safety configuration saved on the Paramodul is saved in the safety module.
    - ⇒ After successful data transmission, a fault event is shown on the display.
  16. Optional: If the safety functions have activated in the previous step, acknowledge the fault event with [Esc].
  17. Take the inserted Paramodul back out and insert the new Paramodul removed in step 5 into the drive controller.
  18. Press the [Save] button for 3 seconds.
    - ⇒ All data is stored in non-volatile memory on the Paramodul.

19. Then restart the drive controller, such as using the control unit's 24 V<sub>DC</sub> power supply.
20. Optional: If you are using the expanded safety functionality through the SE6 safety module, check whether the checksum stored in the replaced drive controller's machine documentation for the safety functions matches the checksum of the new drive controller. The checksum is shown on the display. Acknowledge the display with [Esc]. Alternatively, parameter S09 Safety modul SE6 checksum of safety configuration in element 2 is used to display the checksum.

## 21.5 Replacing the Paramodul

If you need to replace the original Paramodul supplied with the drive controller with a new one, you can reorder it from STOBER (see [Removable data storage \[► 41\]](#)).

### Information

A new Paramodul from STOBER is always empty. It must be prepared for operation in the drive controller.

If a spare empty Paramodul from STOBER is plugged in when the drive controller is started, the drive controller starts in emergency operation and an error message appears on the display (see [Drive controller state: Display \[► 317\]](#)).

### Preparation

To replace an original Paramodul and prepare the new one for operation in the drive controller, proceed as described below:

- ✓ The original Paramodul is plugged into the drive controller.

  1. Switch on the 24 V<sub>DC</sub> supply of the control unit.
  2. Replace the original Paramodul with the new one.
  3. Execute the A00 action and wait until saving is finished.

- ⇒ The new Paramodul is prepared for operation in the drive controller.



## 21.6 Replacing or updating firmware using DS6

If you require a different firmware version or want to update the firmware of a drive controller, you can change the firmware using the DriveControlSuite commissioning software. You can prepare a live firmware update while the drive controller and machine are operating. The update does not take effect until after a restart. This dual firmware behavior prevents a firmware loss or appearance of a case of service, since it ensures, for example, that the existing firmware can be accessed if the connection is interrupted.

In order to perform a live firmware update, you must connect your PC and the drive controller over the network.

### Information

During the search, all drive controllers within the broadcast domain are found via IPv4 limited broadcast.

Requirements for finding a drive controller in the network:

- Network supports IPv4 limited broadcast
- All drive controllers and the PC are in the same subnet (broadcast domain)

### Carrying out a live firmware update

- ✓ The drive controller is switched on.
1. Start DriveControlSuite.
  2. Click Assignment and live firmware update.
    - ⇒ The Add connection dialog box opens.
  3. Direct connection tab > IP address column:  
Activate the IP address in question and confirm your selection with OK.
    - ⇒ The Online functions window opens. The drive controller that is connected by the selected IP address is displayed.
  4. Live firmware update tab:  
By default, the newest firmware version suitable for the DriveControlSuite version is selected. Click Assign default version to all drive controllers.
    - ⇒ The selection No live firmware update for the drive controller changes to Default version.
  5. Optional: If you want to assign an alternative, locally saved firmware version to a drive controller, proceed as follows:
    - 5.1. Click on Add new firmware version, navigate to the directory and load the file.
    - 5.2. Then change the selection from Default version of the drive controller to Alternative version and select the previously uploaded firmware version from the associated picklist.
  6. Live firmware update tab:  
Click Start live firmware update.
  7. Confirm the safety instruction with OK.
    - ⇒ The firmware update is transferred.
  8. Since the firmware update only takes effect after the drive controller is restarted, click Restart all drive controllers after completing the transfer.
  9. Confirm the restart with Yes.
    - ⇒ The fieldbus communication and connection to DriveControlSuite are interrupted and the drive controller restarts.

## 22 Service

You can find important information all about our range of services in this chapter.

### 22.1 Information about the product

You can find information about your product online at the following address: <https://id.stober.com>.

In the search field there, enter the serial number, delivery note number or invoice number of the product.

Alternatively, you can use a suitable mobile device to scan in the QR code on the front of the device in order to directly access product information that is available online.

### 22.2 STOBER electronics service

If you need support, please contact our service department (see [Consultation, service and address](#) [► 482]).

Please have the following descriptive information on hand so that we can provide you with quick, professional assistance.

#### Ordering a replacement device

If you would like to order a replacement device, our System Support requires the following information:

- MV and serial number of the drive controller being replaced (see Material variant)
- Information on subsequent changes (e.g. change in option modules, application or firmware)

The MV number indicates the ordered and delivered material variant, i.e. the device-specific combination of all hardware and software components. The serial number is used to determine your customer information. Both numbers are stored in the STOBER enterprise resource planning system and make reordering a drive controller easier in case of service.

#### Service request

If you need assistance or have any questions regarding commissioning, create reverse documentation for your project as your first step. This makes it easier for our System Support to process your request.

## 22.3 Reverse documentation

If you have questions concerning commissioning and would like to contact our service department, start by first creating reverse documentation and send this to our System Support email address (see [Consultation, service and address \[► 482\]](#)).

### 22.3.1 Drive controller without SE6 option

In order to create reverse documentation, you must connect your PC and the drive controller over the network.

#### Information

During the search, all drive controllers within the broadcast domain are found via IPv4 limited broadcast.

Requirements for finding a drive controller in the network:

- Network supports IPv4 limited broadcast
- All drive controllers and the PC are in the same subnet (broadcast domain)

#### Creating reverse documentation in a new project

- ✓ The drive controller is switched on.
1. Start DriveControlSuite.
  2. Click on Read project.
    - ⇒ The Add connection dialog box opens.
  3. Direct connection tab > IP address column:  
Activate the IP address in question. Confirm your selection with OK.
    - ⇒ The Online functions window opens. The drive controller that is connected using the previously selected IP address is displayed.
  4. Online tab:  
Click Establish online connection.
    - ⇒ The data connection is established and the project configuration data is transmitted from the drive controller to the PC.
    - ⇒ The drive controller is created in the project tree and is active.
  5. Then in the Online connection window > Online tab, click on Set all drive controllers to offline (with reverse documentation).
  6. Confirm the Reverse documentation dialog box with OK.
    - ⇒ The connection is disconnected.
    - ⇒ The drive controller is write-protected (lock status with red R).
  7. Save the project in a local directory and send the file to us.

### Loading reverse documentation in an existing project

- ✓ The drive controller is switched on.
- ✓ A project file for your drive system exists.
- 1. Start DriveControlSuite.
- 2. On the start screen, click **Open project** or select a project from the **Last projects used list**.
  - ⇒ The existing project is opened.
- 3. In the project menu, click **Online connection**.
  - ⇒ The **Add connection dialog box** opens.
- 4. **Direct connection tab > IP address column**:  
Activate the IP address in question. Confirm your selection with **OK**.
  - ⇒ The **Online functions window** opens. The drive controller that is connected using the previously selected IP address is displayed. By default, it is ignored for the data synchronization.
- 5. **Online tab**:  
Click **Set all to read** in order to activate the drive controller for read data synchronization.
- 6. Click **Assign all based on reference** to assign the drive controller to the configured drive controller.
- 7. Then click **Establish online connection**.
  - ⇒ The data connection is established and the project configuration data is compared; if the project configuration data is identical, only the parameter values are transmitted from the drive controller to the PC.
  - ⇒ The drive controller is updated in the project and is active.
- 8. Then in the **Online functions window > Online tab**, click **Set all drive controllers to offline (with reverse documentation)**.
- 9. Confirm the **Reverse documentation dialog box** with **OK**.
  - ⇒ The connection is disconnected.
  - ⇒ The drive controller is write-protected (lock status with red R).
- 10. Save the project in a local directory and send the file to us.

## 22.3.2 Drive controller with SE6 option

In order to create reverse documentation, you must connect your PC and the drive controller over the network.

### Information

During the search, all drive controllers within the broadcast domain are found via IPv4 limited broadcast.

Requirements for finding a drive controller in the network:

- Network supports IPv4 limited broadcast
- All drive controllers and the PC are in the same subnet (broadcast domain)

### Creating reverse documentation in a new project

- ✓ The drive controller is switched on.
  - ✓ The password for the safety configuration is present.
1. Start DriveControlSuite.
  2. Click on Read project.
    - ⇒ The Add connection dialog box opens.
  3. Direct connection tab > IP address column:  
Activate the IP address in question. Confirm your selection with OK.
    - ⇒ The Online functions window opens. The drive controller that is connected using the previously selected IP address is displayed.
  4. Online tab:  
Click Establish online connection.
    - ⇒ The data connection is established and the project configuration data is transmitted from the drive controller to the PC.
    - ⇒ The drive controller is created in the project tree and is active.
    - ⇒ A dialog box prompts you to open the PASmotion configuration tool.
  5. Confirm the dialog box with Yes.
    - ⇒ PASmotion opens.
  6. In the PASmotion project administration, navigate to the safety module for the drive controller and double-click to open it.
    - ⇒ The dialog box for the password prompt opens.
  7. Enter the password and confirm with OK.
    - ⇒ The wizard for device synchronization opens.
    - ⇒ Device configuration and project configuration are checked against each other automatically.
  8. Optional: If the configurations match, click on Done after device synchronization has finished.
  9. Optional: If the configurations do not match, click on Next after device synchronization has finished.
    - 9.1. Confirm the production number of the safety module and click Next.
    - 9.2. Enter the password for the configuration on the safety module and click Next.
    - 9.3. Click Upload to transfer the device configuration to the project.
    - 9.4. After the successful transfer, click Done.

10. Exit PASmotion.
11. Then in the Online functions window > Online tab, click Set all drive controllers to offline (with reverse documentation).
12. Confirm the Reverse documentation dialog box with OK.
  - ⇒ The connection is disconnected.
  - ⇒ The drive controller is write-protected (lock status with red R).
13. Save the project in a local directory and send the file to us.

### Loading reverse documentation in an existing project

- ✓ The drive controller is switched on.
  - ✓ The password for the safety configuration is present.
  - ✓ A project file for your drive system exists.
1. Start DriveControlSuite.
  2. Click on Open project.
  3. Navigate to the directory and load the file.
  4. In the project menu, click Online connection.
    - ⇒ The Add connection dialog box opens.
  5. Direct connection tab > IP address column:  
Activate the IP address in question. Confirm your selection with OK.
    - ⇒ The Online functions window opens. The drive controller that is connected using the previously selected IP address is displayed. By default, it is ignored for the data synchronization.
  6. Online tab:  
Click Set all to read in order to activate the drive controller for read data synchronization.
  7. In the context menu, select Assign all according to reference in order to assign the drive controller to the configured drive controller.
  8. Then click Establish online connection.
    - ⇒ The data connection is established and the project configuration data is compared; if the project configuration data is identical, only the parameter values are transmitted from the drive controller to the PC.
    - ⇒ The drive controller in the project tree is active.
    - ⇒ A dialog box prompts you to open the PASmotion configuration tool.
  9. Confirm the dialog box with Yes.
    - ⇒ PASmotion opens.
  10. In the PASmotion project administration, navigate to the safety module for the drive controller and double-click to open it.
    - ⇒ The dialog box for the password prompt opens.
  11. Enter the password and confirm with OK.
    - ⇒ The wizard for device synchronization opens.
    - ⇒ Device configuration and project configuration are checked against each other automatically.
  12. Optional: If the configurations match, click on Done after device synchronization has finished.

13. Optional: If the configurations do not match, click on **Next** after device synchronization has finished.
  - 13.1. Confirm the production number of the safety module and click **Next**.
  - 13.2. Enter the password for the configuration on the safety module and click **Next**.
  - 13.3. Click **Upload** to transfer the device configuration to the project.
  - 13.4. After the successful transfer, click **Done**.
14. Exit PASmotion.
15. Then in the **Online functions window > Online tab**, click **Set all drive controllers to offline** (with reverse documentation).
16. Confirm the **Reverse documentation dialog box** with **OK**.
  - ⇒ The connection is disconnected.
  - ⇒ The drive controller is write-protected (lock status with red R).
17. Save the project in a local directory and send the file to us.

## 23 Appendix

### 23.1 Weights

Description	Type	ID No.	Weight without packaging [g]	Weight with packaging [g]
Drive controller size 0	SD6A02	—	2530	3520
	SD6A04	—	2530	3520
	SD6A06	—	2530	3520
Drive controller size 1	SD6A14	—	3700	5470
	SD6A16	—	3700	5470
Drive controller size 2	SD6A24	—	5050	6490
	SD6A26	—	5050	6490
Drive controller size 3	SD6A34	—	13300	14800
	SD6A36	—	13300	14800
	SD6A38	—	13300	14800
Quick DC-Link for drive controller size 0	DL6A0	56440	400	500
Quick DC-Link for drive controller size 1	DL6A1	56441	390	460
Quick DC-Link for drive controller size 2	DL6A2	56442	540	620
Quick DC-Link for drive controller size 3	DL6A3	56443	1540	1580
Quick DC-Link insulation end section	—	56494	10	10
Safety module – STO using terminals	ST6	56431	110	110
Safety module – Expanded safety technology	SE6	56432	110	110
X50 adapter cable (SE6 option)	—	56434	90	90
IGB connecting cable 0.4 m	—	56489	20	20
IGB connecting cable 2 m	—	56490	60	60
PC connecting cables	—	49857	190	190
USB 2.0 Ethernet adapter	—	49940	50	50
Communication module	EC6	138425	50	50
	CA6	138427	50	50
	PN6	138426	50	50
EtherCAT cable approx. 0.25 m	—	49313	15	15
EtherCAT cable approx. 0.5 m	—	49314	20	20
Terminal module	IO6	138420	135	135
	XI6	138421	135	135
	RI6	138422	135	135



Description	Type	ID No.	Weight without packaging [g]	Weight with packaging [g]
Interface adapters	AP6A00	56498	30	30
	AP6A01	56522	30	30
	AP6A02	56523	30	30
Braking resistor	FZMU 400×65	49010	2200	2200
	FZZMU 400×65	53895	4170	4170
	GVADU 210×20	55441	300	300
	GBADU 265×30	55442	930	930
	GBADU 405×30	55499	1410	1410
	GBADU 335×30	55443	1200	1200
	FGFKU (22/2500)	55449	7500	7500
	FGFKU (15/2500)	55450	7500	7500
	FGFKU (15/6000)	55451	12000	12000
	FGFKU (15/8000)	53897	18000	18000
Rear section braking resistor	RB 5022	45618	640	640
	RB 5047	44966	460	460
	RB 5100	44965	440	440
Power choke	TEP4010-2US00	56528	9900	9900
Output choke	TEP3720-0ES41	53188	2900	2900
	TEP3820-0CS41	53189	5900	5900
	TEP4020-0RS41	53190	8800	8800
EMC shroud	EM6A0	56459	25	25
	EM6A3	56521	40	40
Battery module	AES	55452	60	60
Removable data storage	Paramodul	56403	5	5

Tab. 362: Weights of SD6 and accessories

## 23.2 Terminal specifications

Relevant information for project configuration of the connecting wiring can be taken from the following chapters.

EN 60204-1 contains basic recommendations that should be taken into account when selecting conductors. The chapter "Conductors and cables" provides specifications for the maximum current carrying capacity of conductors based on the way they are laid as well as tips for derating, for example in the case of increased surrounding temperatures or lines with multiple loaded individual conductors.

**⚠ WARNING!**

**Personal injury and material damage due to electric shock and thermal overload!**

- Prepare the conductor ends according to the terminal specifications.
- In the case of pre-made cables and conductors, check the conductor ends and adjust them if necessary.

### 23.2.1 Overview

The following tables clarify which specifications must be observed for which connections depending on the type of drive controller or accessory.

**Drive controller**

Type	X1	X10, X20	X11	X30
SD6A02	<a href="#">FMC 1,5 -ST-3,5</a> [▶ 431]	<a href="#">GFKC 2,5 -ST-7,62</a> [▶ 432]	<a href="#">BLDF 5.08 180 SN</a> [▶ 429]	<a href="#">GFKIC 2.5 -ST-7.62</a> [▶ 432]
SD6A04				
SD6A06				
SD6A14		<a href="#">SPC 5 -ST-7,62</a> [▶ 434]		<a href="#">ISPC 5 -STGCL-7,62</a> [▶ 433]
SD6A16				
SD6A24				
SD6A26		<a href="#">SPC 16 -ST-10,16</a> [▶ 435]		<a href="#">ISPC 16 -ST-10,16</a> [▶ 433]
SD6A34				
SD6A36		<a href="#">MKDSP 25 -15,00</a> [▶ 434]		—
SD6A38				

Tab. 363: Terminal specifications for the base device

**Safety module**

Type	X2, X5, X6 <sup>49</sup>	X12
ST6	<a href="#">BFL 5.08HC 180 SN</a> [▶ 428]	<a href="#">BCF 3,81 180 SN</a> [▶ 428]

Tab. 364: Terminal specifications of the ST6 safety module

Type	X2, X5, X7, X8 <sup>50</sup>	X14, X15
SE6	<a href="#">BFL 5.08HC 180 SN</a> [▶ 428]	<a href="#">DFMC 1.5 -ST-3.5</a> [▶ 429]

Tab. 365: Terminal specifications of the SE6 safety module

<sup>49</sup> In addition to connections for the safety technology, the functional connections X2, X5, X6 are also located on the ST6 safety module (not related to the safety technology).

<sup>50</sup> In addition to connections for the safety technology, the connections X2 and X5 are also located on the SE6 safety module (not related to the safety technology).

### Terminal modules

Type	X100, X101	X102, X103
XI6	<a href="#">FK-MCP 1,5 -ST-3,5 [▶ 430]</a>	<a href="#">FMC 1,5 -ST-3,5 [▶ 431]</a>
RI6		—
IO6		—

Tab. 366: Terminal specifications for the terminal modules

### Encoder adapter box

Type	X302, X305, X306	X303
LA6	<a href="#">FK-MCP 1,5 -ST-3,5 [▶ 430]</a>	<a href="#">BFL 5.08HC 180 SN [▶ 428]</a>

Tab. 367: Terminal specifications for the encoder adapter box

### Braking resistors

Type	Braking resistor
FZMU, FZZMU	<a href="#">G 10/2 [▶ 431]</a>
FGFKU	<a href="#">G 10/2 [▶ 431]</a>

Tab. 368: Terminal specifications for the braking resistors

### 23.2.2 BCF 3,81 180 SN

Feature	Line type	Value
Contact spacing	—	3.81 mm
Nominal current at $\vartheta_{amb} = 40\text{ °C}$	—	CE/UL/CSA: 16 A/10 A/ 11 A
Max. conductor cross-section	Flexible without end sleeve	1.5 mm <sup>2</sup>
	Flexible with end sleeve without plastic collar	1.0 mm <sup>2</sup>
	Flexible with end sleeve with plastic collar	1.0 mm <sup>2</sup>
	2 conductors, flexible, with double end sleeve with plastic collar	—
	AWG according to UL/CSA	16
Min. conductor cross-section	Flexible without end sleeve	0.14 mm <sup>2</sup>
	Flexible with end sleeve without plastic collar	0.25 mm <sup>2</sup>
	Flexible with end sleeve with plastic collar	0.25 mm <sup>2</sup>
	2 conductors, flexible, with double end sleeve with plastic collar	—
	AWG according to UL/CSA	26
Insulation stripping length	—	10 mm
Tightening torque	—	—

Tab. 369: BCF 3.81 180 SN BK specification

### 23.2.3 BFL 5.08HC 180 SN

Feature	Line type	Value
Contact spacing	—	5.08 mm
Nominal current at $\vartheta_{amb} = 40\text{ °C}$	—	CE/UL/CSA: 16 A/10 A/ 10 A
Max. conductor cross-section	Flexible without end sleeve	2.5 mm <sup>2</sup>
	Flexible with end sleeve without plastic collar	2.5 mm <sup>2</sup>
	Flexible with end sleeve with plastic collar	2.5 mm <sup>2</sup>
	2 conductors, flexible, with double end sleeve with plastic collar	—
	AWG according to UL/CSA	12
Min. conductor cross-section	Flexible without end sleeve	0.2 mm <sup>2</sup>
	Flexible with end sleeve without plastic collar	0.2 mm <sup>2</sup>
	Flexible with end sleeve with plastic collar	0.25 mm <sup>2</sup>
	2 conductors, flexible, with double end sleeve with plastic collar	—
	AWG according to UL/CSA	26
Insulation stripping length	—	10 mm
Tightening torque	—	—

Tab. 370: BFL 5.08HC 180 SN specification

### 23.2.4 BLDF 5.08 180 SN

Feature	Line type	Value
Contact spacing	—	5.08 mm
Nominal current at $\vartheta_{amb} = 40\text{ °C}$	—	CE/UL/CSA: 14 A/10 A/ 10 A
Max. conductor cross-section	Flexible without end sleeve	2.5 mm <sup>2</sup>
	Flexible with end sleeve without plastic collar	2.5 mm <sup>2</sup>
	Flexible with end sleeve with plastic collar	2.5 mm <sup>2</sup>
	2 conductors, flexible, with double end sleeve with plastic collar	—
	AWG according to UL/CSA	12
Min. conductor cross-section	Flexible without end sleeve	0.2 mm <sup>2</sup>
	Flexible with end sleeve without plastic collar	0.2 mm <sup>2</sup>
	Flexible with end sleeve with plastic collar	0.25 mm <sup>2</sup>
	2 conductors, flexible, with double end sleeve with plastic collar	—
	AWG according to UL/CSA	26
Insulation stripping length	—	10 mm
Tightening torque	—	—

Tab. 371: BLDF 5.08 180 SN specification

### 23.2.5 DFMC 1.5 -ST-3.5

Feature	Line type	Value
Contact spacing	—	3.5 mm
Nominal current at $\vartheta_{amb} = 40\text{ °C}$	—	CE/UL/CSA: 8 A
Max. conductor cross-section	Flexible without end sleeve	1.5 mm <sup>2</sup>
	Flexible with end sleeve without plastic collar	1.5 mm <sup>2</sup>
	Flexible with end sleeve with plastic collar	0.75 mm <sup>2</sup>
	2 conductors, flexible, with double end sleeve with plastic collar	—
	AWG according to UL/CSA	16
Min. conductor cross-section	Flexible without end sleeve	0.2 mm <sup>2</sup>
	Flexible with end sleeve without plastic collar	0.25 mm <sup>2</sup>
	Flexible with end sleeve with plastic collar	0.25 mm <sup>2</sup>
	2 conductors, flexible, with double end sleeve with plastic collar	—
	AWG according to UL/CSA	24
Insulation stripping length	—	10 mm
Tightening torque	—	—

Tab. 372: Specification for DFMC 1.5 -ST-3.5

## 23.2.6 FK-MCP 1,5 -ST-3,5

Feature	Line type	Value
Contact spacing	—	3.5 mm
Nominal current at $\vartheta_{amb} = 40\text{ °C}$	—	CE/UL/CSA: 8 A
Max. conductor cross-section	Flexible without end sleeve	1.5 mm <sup>2</sup>
	Flexible with end sleeve without plastic collar	1.5 mm <sup>2</sup>
	Flexible with end sleeve with plastic collar	0.5 mm <sup>2</sup>
	2 conductors, flexible, with double end sleeve with plastic collar	—
	AWG according to UL/CSA	16
Min. conductor cross-section	Flexible without end sleeve	0.14 mm <sup>2</sup>
	Flexible with end sleeve without plastic collar	0.25 mm <sup>2</sup>
	Flexible with end sleeve with plastic collar	0.25 mm <sup>2</sup>
	2 conductors, flexible, with double end sleeve with plastic collar	—
	AWG according to UL/CSA	28
Insulation stripping length	—	9 mm
Tightening torque	—	—

Tab. 373: FK-MCP 1,5 -ST-3,5 specification

### 23.2.7 FMC 1,5 -ST-3,5

Feature	Line type	Value
Contact spacing	—	3.5 mm
Nominal current at $\vartheta_{amb} = 40\text{ °C}$	—	CE/UL/CSA: 8 A
Max. conductor cross-section	Flexible without end sleeve	1.5 mm <sup>2</sup>
	Flexible with end sleeve without plastic collar	1.5 mm <sup>2</sup>
	Flexible with end sleeve with plastic collar	0.75 mm <sup>2</sup>
	2 conductors, flexible, with double end sleeve with plastic collar	—
	AWG according to UL/CSA	16
Min. conductor cross-section	Flexible without end sleeve	0.2 mm <sup>2</sup>
	Flexible with end sleeve without plastic collar	0.25 mm <sup>2</sup>
	Flexible with end sleeve with plastic collar	0.25 mm <sup>2</sup>
	2 conductors, flexible, with double end sleeve with plastic collar	—
	AWG according to UL/CSA	24
Insulation stripping length	—	10 mm
Tightening torque	—	—

Tab. 374: FMC 1,5 -ST-3,5 specification

### 23.2.8 G 10/2

Feature	Line type	Value
Contact spacing	—	17.5 mm
Nominal current at $\vartheta_{amb} = 40\text{ °C}$	—	CE/UL/CSA: 57 A/65 A/ 65 A
Max. conductor cross-section	Flexible without end sleeve	10.0 mm <sup>2</sup>
	Flexible with end sleeve without plastic collar	16.0 mm <sup>2</sup>
	Flexible with end sleeve with plastic collar	16.0 mm <sup>2</sup>
	2 conductors, flexible, with double end sleeve with plastic collar	6.0 mm <sup>2</sup>
	AWG according to UL/CSA	6
Min. conductor cross-section	Flexible without end sleeve	0.5 mm <sup>2</sup>
	Flexible with end sleeve without plastic collar	0.5 mm <sup>2</sup>
	Flexible with end sleeve with plastic collar	0.5 mm <sup>2</sup>
	2 conductors, flexible, with double end sleeve with plastic collar	0.5 mm <sup>2</sup>
	AWG according to UL/CSA	24
Insulation stripping length	—	12 mm
Tightening torque	—	1.5 – 1.8 Nm

Tab. 375: G 10/2 specification

### 23.2.9 GFKC 2,5 -ST-7,62

Feature	Line type	Value
Contact spacing	—	7.62 mm
Nominal current at $\vartheta_{amb} = 40\text{ °C}$	—	CE/UL/CSA: 12 A/10 A/ 10 A
Max. conductor cross-section	Flexible without end sleeve	2.5 mm <sup>2</sup>
	Flexible with end sleeve without plastic collar	2.5 mm <sup>2</sup>
	Flexible with end sleeve with plastic collar	2.5 mm <sup>2</sup>
	2 conductors, flexible, with double end sleeve with plastic collar	1.5 mm <sup>2</sup>
	AWG according to UL/CSA	12
Min. conductor cross-section	Flexible without end sleeve	0.2 mm <sup>2</sup>
	Flexible with end sleeve without plastic collar	0.25 mm <sup>2</sup>
	Flexible with end sleeve with plastic collar	0.25 mm <sup>2</sup>
	2 conductors, flexible, with double end sleeve with plastic collar	0.5 mm <sup>2</sup>
	AWG according to UL/CSA	24
Insulation stripping length	—	10 mm
Tightening torque	—	0.3 – 0.7 Nm

Tab. 376: GFKC 2,5 -ST-7,62 specification

### 23.2.10 GFKIC 2.5 -ST-7.62

Feature	Line type	Value
Contact spacing	—	7.62 mm
Nominal current at $\vartheta_{amb} = 40\text{ °C}$	—	CE/UL/CSA: 12 A/10 A/ 10 A
Max. conductor cross-section	Flexible without end sleeve	2.5 mm <sup>2</sup>
	Flexible with end sleeve without plastic collar	2.5 mm <sup>2</sup>
	Flexible with end sleeve with plastic collar	2.5 mm <sup>2</sup>
	2 conductors, flexible, with double end sleeve with plastic collar	1.0 mm <sup>2</sup>
	AWG according to UL/CSA	12
Min. conductor cross-section	Flexible without end sleeve	0.2 mm <sup>2</sup>
	Flexible with end sleeve without plastic collar	0.25 mm <sup>2</sup>
	Flexible with end sleeve with plastic collar	0.25 mm <sup>2</sup>
	2 conductors, flexible, with double end sleeve with plastic collar	0.5 mm <sup>2</sup>
	AWG according to UL/CSA	26
Insulation stripping length	—	10 mm
Tightening torque	—	—

Tab. 377: Specification for GFKIC 2.5 -ST-7.62



## 23.2.11 ISPC 5 -STGCL-7,62

Feature	Line type	Value
Contact spacing	—	7.62 mm
Nominal current at $\vartheta_{amb} = 40\text{ °C}$	—	CE/UL/CSA: 32 A/35 A/ 35 A
Max. conductor cross-section	Flexible without end sleeve	6.0 mm <sup>2</sup>
	Flexible with end sleeve without plastic collar	6.0 mm <sup>2</sup>
	Flexible with end sleeve with plastic collar	4.0 mm <sup>2</sup>
	2 conductors, flexible, with double end sleeve with plastic collar	1.5 mm <sup>2</sup>
	AWG according to UL/CSA	8
Min. conductor cross-section	Flexible without end sleeve	0.2 mm <sup>2</sup>
	Flexible with end sleeve without plastic collar	0.25 mm <sup>2</sup>
	Flexible with end sleeve with plastic collar	0.25 mm <sup>2</sup>
	2 conductors, flexible, with double end sleeve with plastic collar	0.25 mm <sup>2</sup>
	AWG according to UL/CSA	24
Insulation stripping length	—	15 mm
Tightening torque	—	—

Tab. 378: ISPC 5 -STGCL-7,62 specification

## 23.2.12 ISPC 16 -ST-10,16

Feature	Line type	Value
Contact spacing	—	10.16 mm
Nominal current at $\vartheta_{amb} = 40\text{ °C}$	—	CE/UL/CSA: 55 A/66 A/ 66 A
Max. conductor cross-section	Flexible without end sleeve	16.0 mm <sup>2</sup>
	Flexible with end sleeve without plastic collar	16.0 mm <sup>2</sup>
	Flexible with end sleeve with plastic collar	10.0 mm <sup>2</sup>
	2 conductors, flexible, with double end sleeve with plastic collar	4.0 mm <sup>2</sup>
	AWG according to UL/CSA	4
Min. conductor cross-section	Flexible without end sleeve	0.75 mm <sup>2</sup>
	Flexible with end sleeve without plastic collar	0.75 mm <sup>2</sup>
	Flexible with end sleeve with plastic collar	0.75 mm <sup>2</sup>
	2 conductors, flexible, with double end sleeve with plastic collar	0.75 mm <sup>2</sup>
	AWG according to UL/CSA	20
Insulation stripping length	—	18 mm
Tightening torque	—	—

Tab. 379: SPC 16 -ST-10,16 specification

## 23.2.13 MKDSP 25 -15,00

Feature	Line type	Value
Contact spacing	—	15.0 mm
Nominal current at $\vartheta_{amb} = 40\text{ °C}$	—	CE/UL/CSA: 125 A/115 A/ 115 A
Max. conductor cross-section	Flexible without end sleeve	35.0 mm <sup>2</sup>
	Flexible with end sleeve without plastic collar	35.0 mm <sup>2</sup>
	Flexible with end sleeve with plastic collar	35.0 mm <sup>2</sup>
	2 conductors, flexible, with double end sleeve with plastic collar	16.0 mm <sup>2</sup>
	AWG according to UL/CSA	2
Min. conductor cross-section	Flexible without end sleeve	0.5 mm <sup>2</sup>
	Flexible with end sleeve without plastic collar	1.0 mm <sup>2</sup>
	Flexible with end sleeve with plastic collar	1.5 mm <sup>2</sup>
	2 conductors, flexible, with double end sleeve with plastic collar	0.5 mm <sup>2</sup>
	AWG according to UL/CSA	20
Insulation stripping length	—	18 mm
Tightening torque	Conductor cross-sections $\leq 25.0\text{ mm}^2$	2.5 Nm
	Conductor cross-sections $> 25.0\text{ mm}^2$	4.5 Nm

Tab. 380: MKDSP 25 -15,00 specification

## 23.2.14 SPC 5 -ST-7,62

Feature	Line type	Value
Contact spacing	—	7.62 mm
Nominal current at $\vartheta_{amb} = 40\text{ °C}$	—	CE/UL/CSA: 32 A/35 A/ 35 A
Max. conductor cross-section	Flexible without end sleeve	6.0 mm <sup>2</sup>
	Flexible with end sleeve without plastic collar	6.0 mm <sup>2</sup>
	Flexible with end sleeve with plastic collar	4.0 mm <sup>2</sup>
	2 conductors, flexible, with double end sleeve with plastic collar	1.5 mm <sup>2</sup>
	AWG according to UL/CSA	8
Min. conductor cross-section	Flexible without end sleeve	0.2 mm <sup>2</sup>
	Flexible with end sleeve without plastic collar	0.25 mm <sup>2</sup>
	Flexible with end sleeve with plastic collar	0.25 mm <sup>2</sup>
	2 conductors, flexible, with double end sleeve with plastic collar	0.25 mm <sup>2</sup>
	AWG according to UL/CSA	24
Insulation stripping length	—	12 – 15 mm
Tightening torque	—	0.3 – 0.7 Nm

Tab. 381: SPC 5 -ST-7,62 specification

## 23.2.15 SPC 16 -ST-10,16

Feature	Line type	Value
Contact spacing	—	10.16 mm
Nominal current at $\vartheta_{amb} = 40\text{ °C}$	—	CE/UL/CSA: 55 A/66 A/ 66 A
Max. conductor cross-section	Flexible without end sleeve	16.0 mm <sup>2</sup>
	Flexible with end sleeve without plastic collar	16.0 mm <sup>2</sup>
	Flexible with end sleeve with plastic collar	10.0 mm <sup>2</sup>
	2 conductors, flexible, with double end sleeve with plastic collar	4.0 mm <sup>2</sup>
	AWG according to UL/CSA	4
Min. conductor cross-section	Flexible without end sleeve	0.75 mm <sup>2</sup>
	Flexible with end sleeve without plastic collar	0.75 mm <sup>2</sup>
	Flexible with end sleeve with plastic collar	0.75 mm <sup>2</sup>
	2 conductors, flexible, with double end sleeve with plastic collar	0.75 mm <sup>2</sup>
	AWG according to UL/CSA	20
Insulation stripping length	—	18 mm
Tightening torque	—	0.3 – 0.7 Nm

Tab. 382: SPC 16 -ST-10,16 specification

## 23.3 Wiring examples

The following chapters show the basic connection using examples.

**Information**

For UL-compliant operation: The connections marked with PE are intended solely for the functional grounding.

### 23.3.1 Stand-alone operation with direct brake control

The following graphic shows a wiring example for the stand-alone operation of SD6 with direct brake control.

Note the information on EMC-compliant installation (see [EMC recommendations](#) [▶ 144]).

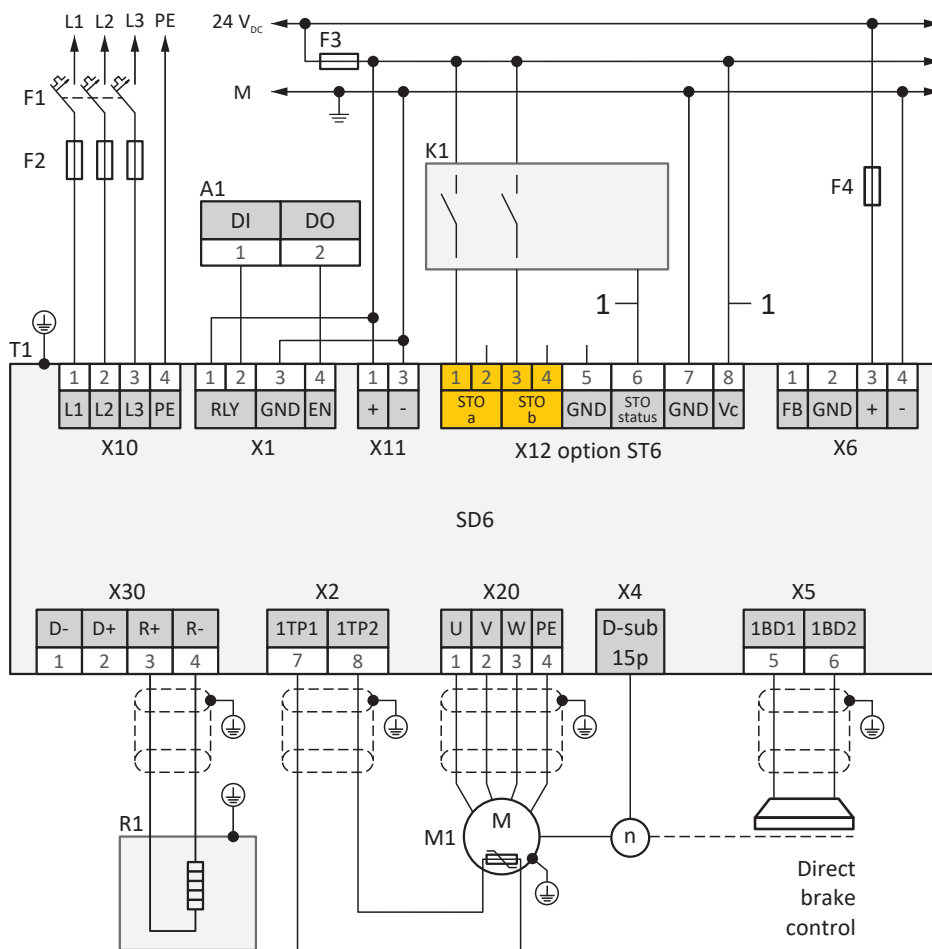

Fig. 96: Wiring example of stand-alone operation with direct brake control

- A1        Controller
- F1 – F4    Fuse
- K1        Safety relay
- L1 – L3    Three-phase power supply
- M        Reference potential
- M1        Motor
- R1        Braking resistor
- T1        Drive controller
- 1        Optional connection

### 23.3.2 Stand-alone operation with indirect brake control

The following graphic shows a wiring example for the stand-alone operation of SD6 with indirect brake control.

Note the information on EMC-compliant installation (see [EMC recommendations \[▶ 144\]](#)).

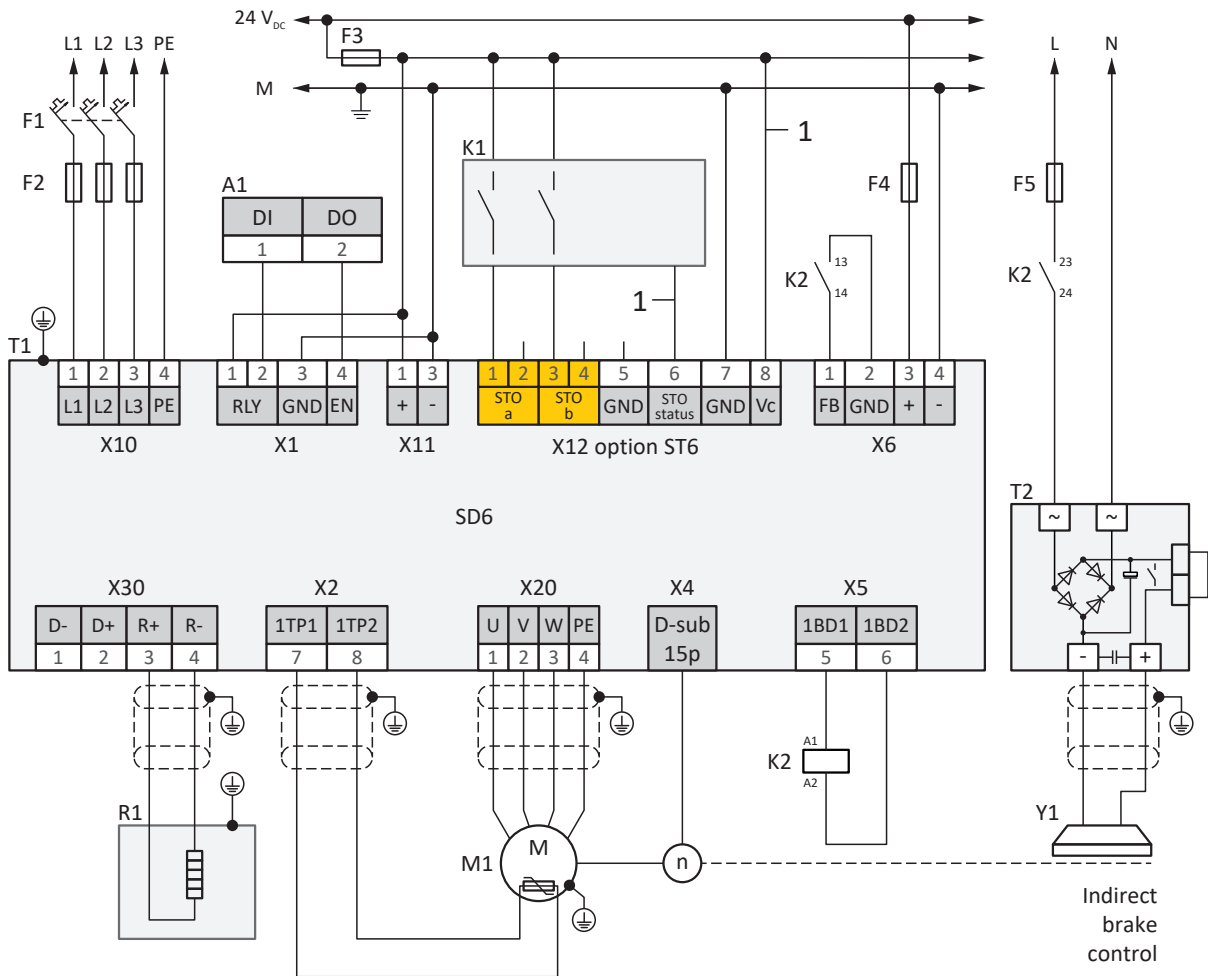

Fig. 97: Wiring example of stand-alone operation with indirect brake control

- A1      Controller
- F1 – F5      Fuse
- K1      Safety relay
- K2      Contactor
- L      230 V<sub>AC</sub> supply
- L1 – L3      Three-phase power supply
- M      Reference potential
- 24 V<sub>DC</sub>      24 V<sub>DC</sub> supply
- M1      Motor
- N      Neutral conductor
- R1      Braking resistor
- T1      Drive controller
- T2      Brake rectifier
- Y1      Brake
- 1      Optional connection

01/2023 | ID 442426.12

### 23.3.3 DC link connection

The following graphic shows the basic connection of multiple SD6 drive controllers based on a DC link connection with DL6A Quick DC-Link.

Note the information on EMC-compliant installation (see [EMC recommendations](#) [▶ 144]).

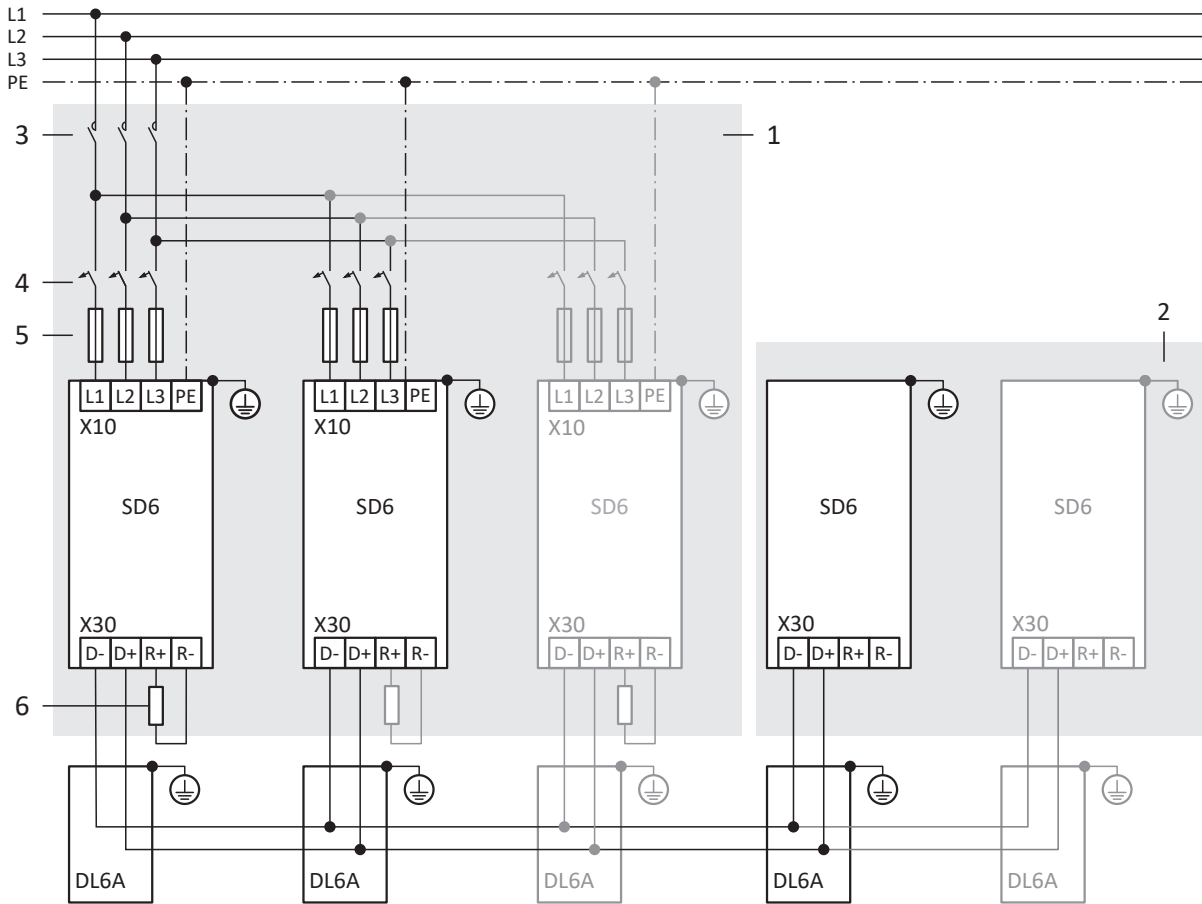

Fig. 98: Wiring example with Quick DC-Link

- 1 Group 1
- 2 Group 2
- 3 Grid contactor
- 4 Miniature circuit breakers
- 5 Short-circuit protection
- 6 Braking resistor: Dimension the braking resistor in accordance with the Quick DC-Link braking power and the technical data of the drive controller

## 23.4 Device addressing

### MAC address

A MAC address consists of a fixed and a variable portion. The fixed portion designates the manufacturer and the variable portion distinguishes the individual network nodes and must be universally unique.

The MAC addresses of the interfaces are issued by STOBER and cannot be changed.

---

<b>Information</b>
--------------------

---

The MAC address range of the STOBER hardware is: 00:11:39:00:00:00 – 00:11:39:FF:FF:FF

---

### IP address – Value range

An IPv4 address always consists of 4 decimal numbers, each in a range from 0 to 255, and separated by periods. It must be unique within a (sub)network.

### Subnet and subnet mask – Value range

Subnets are created in order to provide standalone networks with their own address range. Each IP address is divided into a network and host address. The subnet mask determines where this division takes place.

Like the IP address, the subnet mask consists of 4 decimal numbers, each in a range from 0 to 255, separated by periods.

### Assignment for direct connection

In the default factory settings, both the IP address and the subnet mask are automatically assigned by DriveControlSuite or using DHCP for a direct connection. Alternatively, you can switch to manual parameterization using parameter A166.

The active address is displayed in parameter A157 and the active subnet mask in parameter A158.

### Assignment for fieldbus connection

Note that the IP address and subnet mask are assigned by the controller for a fieldbus connection.

## 23.5 DriveControlSuite

The DriveControlSuite commissioning software uses wizards to guide you step by step through the installation process. You can find more detailed information on the system requirements and installation in the following chapters.

### 23.5.1 System requirements

The following minimum requirements for the PC system apply to the installation and operation of the DriveControlSuite commissioning software, including the integrated PASMotion component, for configuring the SE6 safety module:

- Operating system: Windows 10 (32 bit, 64 bit \*)
- Processor: Intel Pentium 4 (2 GHz, Dual Core) or equivalent
- Memory: 2 GB
- Free disk space on the hard disk: 1 GB
- Graphics: 1024 × 768 pixel resolution, 65536 colors
- Font size: 100% (default)
- Interfaces: 100 Mbps Ethernet (Fast Ethernet, copper)
- Display of documentation: Adobe Acrobat Reader version 7.1.0 or later\*\*

\*) Only DriveControlSuite

\*\*\*) Only PASMotion

### 23.5.2 Installation types

To install the DriveControlSuite commissioning software, select one of two installation types.

#### Default installation

Select this installation type if you want to install the latest version of DriveControlSuite. DriveControlSuite is installed in the version-independent .../Programs/STOBER/DriveControlSuite/ directory. During the installation process, you do not need to specify any additional installation instructions.

Provided that you are connected to the Internet, a check is performed prior to installation to determine if a newer software version is available. If a newer version is already available, it is downloaded and installed in place of the started version.

If an older software version is already installed on your PC, it is deleted prior to installation. However, if the latest version is already installed on your PC, a new installation is not performed.

#### User-defined installation

Select this installation type if you want to install a specific version of DriveControlSuite or if you still need an older version that is already installed on your PC. You can use this installation type to change the default installation directory and manage the version-dependent destination folders.

Checking whether the software version is up-to-date before installation is optional.



## 23.5.3 Installing DriveControlSuite

Current versions of the DriveControlSuite commissioning software can be found in our download center at <http://www.stoeber.de/en/downloads/>.

### Information

If you use the expanded safety function via the SE6 safety module, you also need the PASmotion component integrated into DriveControlSuite. To this end, the PASmotion installation wizard starts at the end of the DriveControlSuite installation process. You can either perform installation of the component for the safety configuration or cancel it if you do not need it.

- ✓ You have administrator rights.
  - ✓ The DriveControlSuite software is currently not running.
  - ✓ You have downloaded the setup file from the STOBER Download Center and saved it locally.
1. Start the installation via the setup file.
  2. Select the language for the installation and confirm with OK.
  3. Select Default as the installation type.
    - ⇒ If an Internet connection is available, the recency of the setup file is checked and, if necessary, the latest version is downloaded.
    - ⇒ The latest DriveControlSuite version is installed.
    - ⇒ After successful installation, DriveControlSuite checks the access to the network.
    - ⇒ If a firewall is active, a safety instruction opens according to the firewall settings.
  4. If applicable, allow DriveControlSuite to communicate on public and private networks.
  5. PASmotion:
    - If you are using the SE6 safety module, follow the steps in the PASmotion installation wizard.
    - ⇒ After successful installation, DriveControlSuite opens automatically.

## 23.5.4 Updates

In the Help menu of the DriveControlSuite commissioning software, you can search for a newer version and, if available, download and install it.

### Information

If the DriveControlSuite version is outdated, but the latest version is already installed on the computer, the check will yield the result that no newer version is available.

## 23.5.5 Communication requirements

Note the following requirements for direct connection, remote maintenance and IGB network.

### 23.5.5.1 Personal firewall

For communication, both DriveControlSuite and the SATMISL communication service must be enabled in the PC's firewall.

Test communication is initiated during the installation of DriveControlSuite that opens a dialog box for enabling communication in case of an activated firewall. Note that operation on public networks must also be enabled for communication using mobile network adapters.

The required setup file for installing DriveControlSuite can be found in the STOBER Download Center at <http://www.stoeber.de/en/downloads/>.

Program/service	Path
DS6A.exe (DriveControlSuite)	Standard installation: C:\Program Files (x86)\STOBER\DriveControlSuite\bin  Parallel installation of different versions (version 6.X-X): C:\Program Files (x86)\STOBER\DriveControlSuite (V 6.X-X)\bin
SATMISLVC.exe (SATMISL service)	32-bit Windows 7 or 32-bit Windows 10: C:\Windows\System32  64-bit Windows 7 or 64-bit Windows 10: C:\Windows\SysWOW64

Tab. 383: Programs and services

### 23.5.5.2 Protocols and ports for communication using routers

For communication using routers, the protocols and ports used by DriveControlSuite and the SATMISL communication service must be enabled in the routers, if applicable.

Protocol	Port	Use	Program/service
UDP/IP	37915	Connection test (inquiry)	SATMISL service
UDP/IP	37916	Node search	SATMISL service
UDP/IP	30001	Primary port for connection response (response)	SATMISL service
	30002 – 39999	Alternative ports for connection response (response)	
UDP/IP	40000	Primary port for IP address specification	DriveControlSuite
	40001 – 50000	Alternative ports for IP address specification	
TCP/IP	37915	Data transmission	DriveControlSuite

Tab. 384: Protocols and ports for a direct connection

Protocol	Port	Use
TCP	80	Data transmission using HTTP

Tab. 385: Protocols and ports for STOBER remote maintenance

### 23.5.5.3 IGB and IGB motion bus network

An IGB network is used for pure service background communication, whereas data is exchanged synchronously within an IGB-motion bus network.

An IGB motion bus network exchanges data synchronously and in real time. The network is particularly well suited to the synchronous operation of drive controllers in order to exchange master value positions or actual and set values regarding velocity and torque. The IGB motion bus network is also used for graphical programming, such as for configuring the transmission and processing of any data.

Both network variants require the following conditions:

- At least 2 and up to 32 SD6 devices can be networked
- All nodes in the respective network must be connected with each other directly—without any intermediary hubs or switches
- Both networks must follow a line topology
- The X3A interfaces may be connected only to the X3B interfaces of other drive controllers and vice versa
- The use of a suitable Ethernet cable is required for a functioning network; STOBER offers pre-made cables for setting up an IGB or IGB motion bus network
- The total length of each network can be up to 100 m
- There is no complicated fieldbus configuration, even when commissioning master/slave systems

X3A gateway socket for connecting PC or Internet

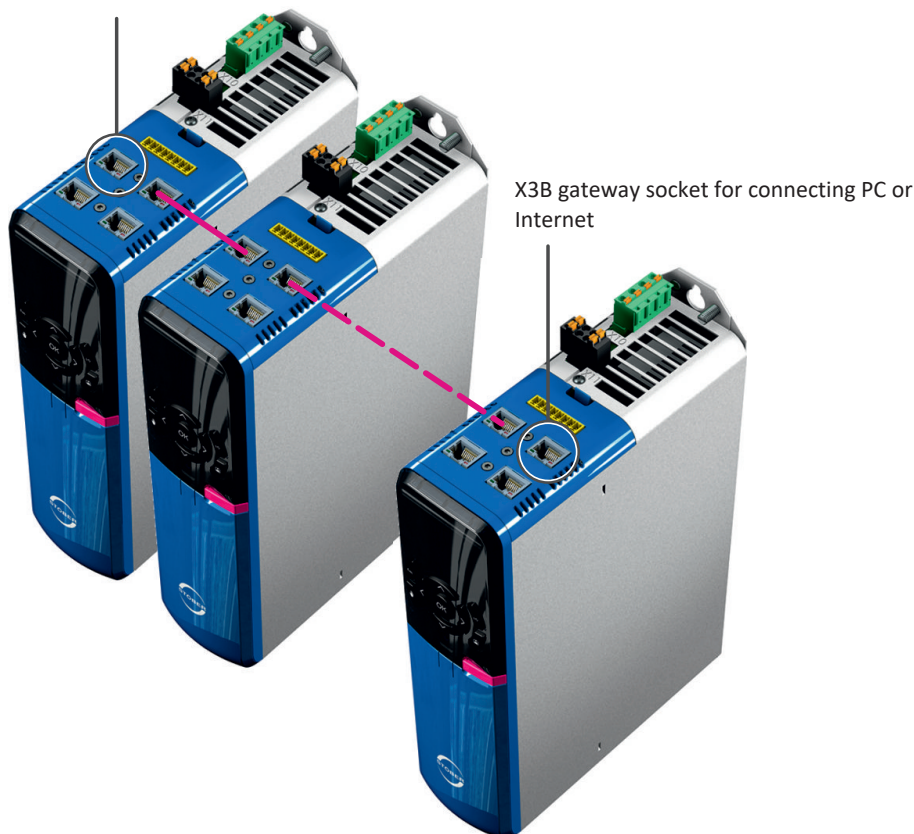

Fig. 99: IGB and IGB motion bus network

The PC or Internet is connected to one of the two open external sockets. The IGB motion bus network is set up automatically once you switch on at least one drive controller. For integrating additional drive controllers into the IGB motion bus network, the following conditions apply:

- You have integrated the drive controllers in question into the IGB motion bus network
- The drive controllers involved must be supplied with 24 V<sub>DC</sub>

In order to start integration, the 24 V<sub>DC</sub> supply must be switched on at one of the connected drive controllers. When the 24 V<sub>DC</sub> supply is switched on, the IGB motion bus network is re-established and the connected drive controllers are integrated.

For information on device addressing, see [Device addressing](#) [▶ 439].

## 23.5.6 Configuring virtual machines

If you would like to connect STOBER drive controllers to the DriveControlSuite commissioning software from a virtual machine, you have to configure the communication between the virtual machine and host so that, from the perspective of the network, the virtual machine is no different from a physical PC.

### **VMware, Inc. VMware**

If you use the VMware software from the company of the same name as a virtual machine, configure it in the VMware Workstation. For the direct connection, the virtual network card is operated as a network bridge.

### **Microsoft Windows Virtual PC**

If you use the Windows Virtual PC software from Microsoft as a virtual machine, configure it in the Virtual PC software and in the Virtual Server. In both components, the name of the virtual network card has to match the physical network card. For Virtual PC network connections, Microsoft distinguishes between the **Public** and **Private** types. For the direct connection, the virtual network card is operated on the Virtual Server with the Public connection type.

### **Microsoft Hyper-V**

If you use the Hyper-V software from Microsoft as a virtual machine, configure a Virtual Switch Manager in the Hyper-V Manager.

For network connections through Virtual Switch, Microsoft distinguishes between the **External**, **Internal** and **Private** types. For the direct connection, the virtual network card is operated with the External connection type.

### **Oracle VirtualBox**

If you use the VirtualBox software from Oracle as a virtual machine, configure the network directly in VirtualBox. For the direct connection, a virtual network adapter is operated in bridge mode.

## 23.5.7 Script mode

Script mode is an automation function of the DriveControlSuite commissioning software. In Script mode, commands can be processed automatically. For example, this includes opening and closing project files or changing parameters. Processing commands can be used for executing various actions, such as transmitting a firmware update to multiple drive controllers.

When Script mode is called up from DriveControlSuite, a window with the same name opens. Here, you can transfer commands to DriveControlSuite in the form of a command script.

When you switch from Script mode to DriveControlSuite, the instance of DriveControlSuite being run in the background becomes visible.

---

**Information**

It is not possible to send a safety configuration to or read one from the SE6 safety module using Script mode.

---

### 23.5.7.1 Script mode window

In the DriveControlSuite – Script mode window, you can execute a command script and view information about the status of the script.

Information

The DriveControlSuite – Script mode window can be reached via the keyboard shortcut [Ctrl] + [F9] when DriveControlSuite is open and by executing a command script by double-clicking the batch file when DriveControlSuite is closed.

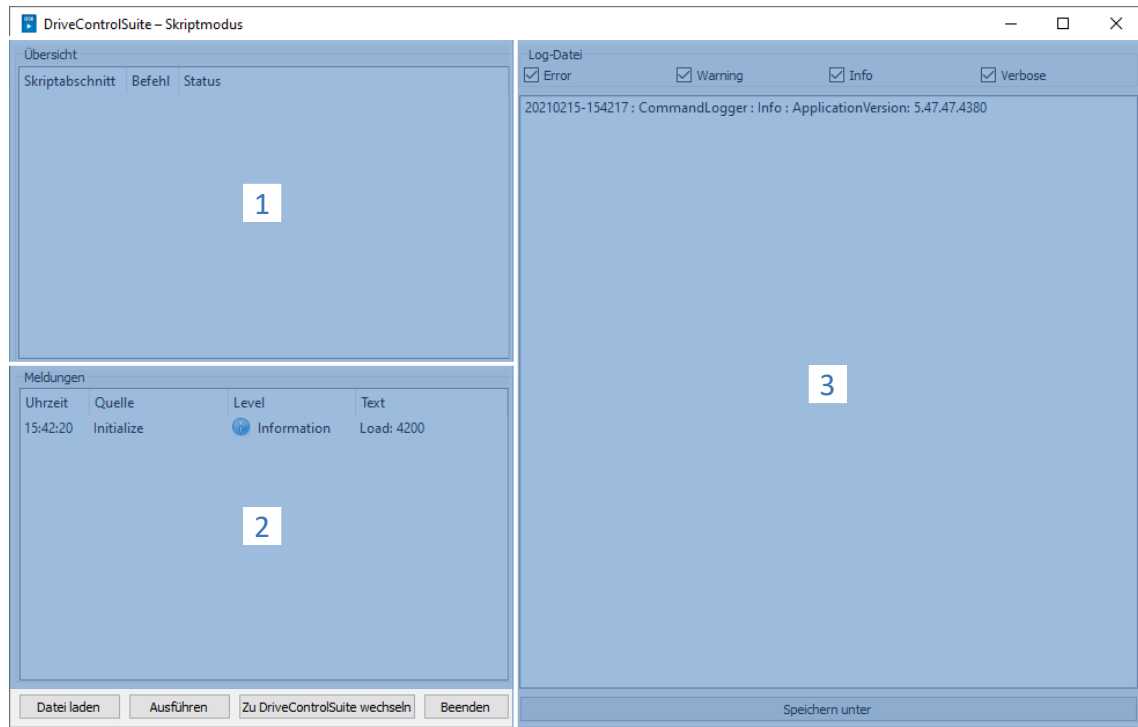

Fig. 100: Script mode: Program interface

No.	Area	Description
1	Overview	The Overview area informs you about the progress of the individual script sections.
2	Messages	The entries in the messages log the connection and communication status of the drive controllers, incorrect inputs caught by the system, errors when opening a project or rule violations in the graphical programming.
3	Log file	The Log file area shows the entries that are written to the log file while the command script is running. Each entry is output with a time stamp and source and can be filtered by its level through use of the options above the entries (Error, Warning, Info, Verbose). You can use Save as to save the log file locally.

Button	Description
Load file	Loads a command script in Script mode.
Run	Runs a loaded command script.
Switch to DriveControlSuite	Exits Script mode and switches to DriveControlSuite.
Exit	Exits Script mode and, where applicable, DriveControlSuite.

### 23.5.7.2 Command script structure

The command script is structured in the JSON data format (\*.json) with UTF-8 encoding with BOM. You can find an introduction to JSON at:

<https://www.json.org/json-en.html>

#### Information

To create a script for DriveControlSuite, use a JSON editor such as JSON Editor Online, JSONViewer or Visual Studio Code.

Three data types are used in the script based on the standard JSON RFC-7159:

- Boolean
- String
- Integer

The command script is divided into three sections: settings, sequence and commands.

Script section	Description
settings	In the settings section, you define basic settings for executing the command script.
sequence	In the sequence section, you define the sequence of the individual commands.
commands	In the commands section, you define the individual commands of the command script.

### 23.5.7.2.1 "settings" script section

In the settings section, you define basic settings for executing the command script. You specify whether a log file is created when the script is executed and whether DriveControlSuite is closed after the script ends. The settings section is optional.

#### Attributes

- "logFilePath": Path of the log file, <optional> <string>
- "quitWhenDone": Behavior of DriveControlSuite after script end, <optional> <string>

#### Example

```
"settings": {
  "logFilePath": "%COMMANDFILE%/LoadNewConfig.log",
  "quitWhenDone": "never"
},
```

#### Creating a log file (logFilePath)

The log file logs the progress of a command script in chronological order. You create a log file by using the logFilePath attribute to specify the file path under which the log file is to be created. If you specify a file path for the log file, the command script will be executed only if the log file could be created successfully.

You can specify the file path for the log file either absolutely or relative to the command script directory (%COMMANDFILE%), \\ or / serve as separators of the path. By specifying %TIMESTAMP%, you can add the current time stamp (format: YYYYMMDD-hhmmss) to the file name and thus create a new log file each time the command script is executed. Without a time stamp in the file name, the log file will be overwritten each time the command script is executed.

#### Quit when done (quitWhenDone)

quitWhenDone can have three values assigned to it, which determine the behavior after the script is done.

"never"	DriveControlSuite remains open after the script has ended (default value).
"noErrors"	DriveControlSuite is closed after the script has ended, insofar as no errors have occurred.
"always"	DriveControlSuite is closed after the script has ended in every case.

### 23.5.7.2.2 "sequence" script section

In the sequence section, you define the sequence of the individual commands. The commands are specified as an array of strings with the key "sequence" and the name you specify in the commands section. A command can occur any number of times in the array.

The order in the array corresponds to the order in which the commands are executed in the command script. Set a reasonable order for the commands so that the command script does not abort with an error if a command cannot be executed. For example, you must first open a project (openProject) before you can change a parameter in it (setParameter).

#### Example

```
"sequence": [
  "commandName 1",
  "commandName 2",
  "commandName 1",
  "commandName 3"
],
```



### 23.5.7.2.3 "commands" script section

In the commands section, you define the individual commands of the command script. A command consists at least of a name and the "command" attribute, which determines the command and the further attributes of the command.

#### Example

```
"commandName1": {
  "command": "commandName",
  "attributeKey": "attributeValue"
},
```

### 23.5.7.3 Script mode commands

In the following, all available commands are described with the corresponding attributes.

The following table shows an overview of the available commands.

Command	Description
<a href="#">openProject [▶ 450]</a>	Open project file
<a href="#">closeProject [▶ 450]</a>	Close project file
<a href="#">connect [▶ 451]</a>	Establish connection
<a href="#">disconnect [▶ 452]</a>	Disconnect connection
<a href="#">setOnline [▶ 452]</a>	Send/read out configuration
<a href="#">setOnlineByPreset [▶ 453]</a>	Send/read out configuration according to the presets
<a href="#">setOffline [▶ 454]</a>	Set offline
<a href="#">updateFirmware [▶ 455]</a>	Multiple live firmware updates
<a href="#">setParameter [▶ 456]</a>	Modify parameters
<a href="#">performAction [▶ 456]</a>	Execute action
<a href="#">openMessageBox [▶ 457]</a>	Open message window
<a href="#">wait [▶ 457]</a>	Wait
<a href="#">exportParameter [▶ 458]</a>	Export parameters
<a href="#">importParameter [▶ 459]</a>	Import parameters
<a href="#">updateTemplates [▶ 460]</a>	Update project configuration
<a href="#">takeSnapShot [▶ 461]</a>	Read out reverse documentation
<a href="#">discardReverseDocumentation [▶ 462]</a>	Discard reverse documentation

Tab. 386: Script mode commands

### 23.5.7.3.1 openProject

With the command `openProject`, you can open a project in Script mode, which is required for many commands. When you open a project with `openProject`, `closeProject` is automatically called for the current project.

#### Attributes

- `"filePath"`: directory of the project file (\*.ds6), <binding> <string>

#### Description

In the `filePath` attribute, you specify the name of the project file to be opened. The specification can be made either as an absolute value or relative to the command script directory (`%COMMANDFILE%`).

#### Example

```
"openProjectfile": {
  "command": "openProject",
  "filePath": "<your path>"
},
```

### 23.5.7.3.2 closeProject

With the `closeProject` command, you can close an open project in Script mode. When you open a project with `openProject`, `closeProject` is automatically called for the current project.

#### Attributes

- `"saveAs"`: Storage directory of the project file (\*.ds6), <optional> <string>
- `"saveBeforeClose"`: <optional> <Boolean>

#### Description

`saveAs` specifies the storage location of the project. Alternatively, the project can be saved at the path specified in the `filePath` attribute before it is closed with `saveBeforeClose: true`. By default, a dialog box opens if the project has been modified.

#### Example

```
"closeProjectfile": {
  "command": "closeProject",
  "saveBeforeClose": true
},
```

### 23.5.7.3.3 connect

With the connect command, you can establish a direct connection to the drive controllers of a module in Script mode.

Requirements for communication with the drive controllers include a direct connection to the gateway drive controller and assignment to the module within the project under which this drive controller is recorded.

#### Attribute

- "module": Reference of the module in the project, <binding> <string>

One of the attributes listed below must be specified for the assignment. The IP address can always be used. The production number can be used only if the drive controller can be found by searching in a network. The reference can be used only if the drive controller can be found by searching in a network and a unique reference is defined for each drive controller that is found:

- "ipAddress": IPv4 address of the direct connection, <optional> <string>
- "serialNumber": Production number of the gateway drive controller, <optional> <integer>
- "reference": Reference of the gateway drive controller, <optional> <string>

#### Information

During the search, all drive controllers within the broadcast domain are found via IPv4 limited broadcast.

Requirements for finding a drive controller in the network:

- Network supports IPv4 limited broadcast
- All drive controllers and the PC are in the same subnet (broadcast domain)

#### Description

The command establishes a direct connection to the gateway drive controller with the corresponding IP address, production number or reference. Establishing a connection using Internet remote maintenance or LAN-based remote maintenance is not supported.

#### Example

```
"ipConnect": {
  "command": "connect",
  "module": "M1",
  "ipAddress": "192.168.3.2"
},
"serialnumberConnect": {
  "command": "connect",
  "module": "M1",
  "serialNumber": 70012345
},
"referenceConnect": {
  "command": "connect",
  "module": "M1",
  "reference": "T123"
},
```

### 23.5.7.3.4 disconnect

With the disconnect command, you can disconnect all existing direct connections in Script mode (without reverse documentation).

#### Example

```
"DisconnectAll": {
  "command": "disconnect"
},
```

### 23.5.7.3.5 setOnline

With the setOnline command, you can establish an online connection in Script mode to send a configuration from the project to the drive controller or to read it from the drive controller into the project.

#### Attributes

- "direction": Read or send access; read or write, <optional> <string>
- "reference": Reference of the drive controller in the project, <optional> <string>
- "targetId": Reference, production number or IGB position of the physical drive controller, <optional> <string> or <integer>
- "targetType": igbPosition, serialNumber or reference, <optional> <string>
- "connectAndAssignMethod": serialNumber or reference, <optional> <string>

#### Description of single connection

The configuration of the active project file specified with "reference" is loaded into the specified drive controller or vice versa. The specification must be unique. Based on the content of targetType, a decision is made about how to interpret the content of targetId. The online connection is established in the reading or sending direction according to the attribute.

Value set of targetType:

1. "igbPosition": The position of the drive controller is determined for the IGB based on the plug sequence; assignment takes place based on this position; the left, outer drive controller in the IGB has the position 0 (zero)
2. "serialNumber": The assignment is made using the production number of the drive controller
3. "reference": The assignment is made based on the reference already existing in the drive controller (E120); this was assigned during the most recently executed project configuration

It is always a prerequisite that a drive controller with this igbPosition, production number or reference must be in the established connection.

#### Description of multi-connection

When using the connectAndAssignMethod attribute with the values serialNumber or reference (see example 4), the configurations of the active project file are loaded to the corresponding drive controllers most recently connected or vice versa. The online connection is established in the reading or sending direction according to the attribute.

## Examples

### Example 1

The configuration of the projected drive controller T1 is loaded into the device with the production number 7000026.

```
"sendConfigFromT1to7000026": {
  "command": "setOnline",
  "direction": "write",
  "reference": "T1",
  "targetId": 7000026,
  "targetType": "serialNumber"
},
```

### Example 2

```
"readConfigOutOfIgb5intoT2": {
  "command": "setOnline",
  "direction": "read",
  "reference": "T2",
  "targetId": 5,
  "targetType": "igbPosition"
},
```

### Example 3

```
"writeFromT3ToArAlt": {
  "command": "setOnline",
  "direction": "write",
  "reference": "T3",
  "targetId": "ArAlt",
  "targetType": "reference"
},
```

### Example 4

```
"setOnline": {
  "command": "setOnline",
  "direction": "write",
  "connectAndAssignMethod": "reference"
},
```

#### 23.5.7.3.6 Sending/reading out a configuration according to the presets (setOnlinebyPreset)

With the setOnlineByPreset command, you can establish an online connection in Script mode to send a configuration from the project to the drive controller or to read it from the drive controller into the project. The command uses the presets stored in the project to establish the connection. If you do not specify any specific drive controllers via the attributes, an online connection is established for all drive controllers in the project.

If you store presets for the connection setup in the project, you can easily store a command script or reuse it for multiple projects. For more information on the presets, see [Presetting connections](#) [▶ 464].

#### Attributes

- "module": Reference of the module, <optional> <string>
- "reference": Reference of the drive controller, <optional> <string>
- "direction": Read of send access; read or write; overwrites the preset transmission direction, <optional> <string>

#### Description

The transmission applies to one individual drive controller based on the specification of module and reference (see example 1), but it can also be defined for all drive controllers pre-defined in the project (see example 2).

## Examples

### Example 1

```
"singleConnectByPresets": {  
  "command": "setOnlineByPreset", "module": "m1", "reference": "T1"  
},
```

### Example 2

```
"multiConnectByPresets": {  
  "command": "setOnlineByPreset"  
},
```

#### 23.5.7.3.7 setOffline

With the setOffline command, you can disconnect the online connection to all connected drive controllers in Script mode (with or without reverse documentation). You can save changes to the parameter values of the drive controller before disconnecting.

#### Attribute

- "reverseDocumentation": For true or false, reverse documentation is either created or not, <optional> <Boolean> <default = false>
- "saveValues": For true, the parameter A00 is set to active before setOffline is carried out, <optional> <Boolean> <default = false>

#### Example

```
"setOfflineAndSaveValues":  
{  
  "command": "setOffline",  
  "reverseDocumentation": false,  
  "saveValues": true  
},
```

### 23.5.7.3.8 Updating firmware (updateFirmware)

With the `updateFirmware` command, you can perform a live firmware update in Script mode for a defined list of drive controllers in the network.

#### Attributes

- `"ipAddresses"`: List of IP addresses of the drive controllers at the gateways
- `"serialNumbers"`: List of production numbers of the drive controllers at the gateways, <integer>
- `"references"`: List of references of the drive controllers at the gateways
- `"connectByMethod"`: `serialNumber`, `reference` or `presets`, <optional> <string>
  - `"serialNumber"`: In the open project, all drive controllers are provided with a firmware update whose production number matches the production number defined in the project
  - `"reference"`: In the open project, all drive controllers are provided with a firmware update whose references matches the reference defined in the project
  - `"presets"`: In the open project, all drive controllers are provided with a firmware update that corresponds to the drive controllers defined in the presets
- `"firmwarePath"`: Directory in which the firmware files are stored, <optional>
- `"firmware"`: Firmware version
  - `"default"`: In this value, the version of the target firmware corresponds to the DriveControlSuite version (highest firmware version that was loaded)
- `"restart"`: Restart after the update is finished, <optional> <Boolean> <default = false>
- `"waitForRenewedAvailability"`: Wait until the update has been completed and the drive controllers are available again in the network, <optional> <Boolean> <default = false>

#### Example

```
"updateFirmwareToV_6_4_D": {
  "command": "updateFirmware",
  "firmware": "V 6.4-D",
  "firmwarePath": "<your path>",
  "ipAddresses": ["192.168.3.101",
                 "192.168.3.102",
                 "192.168.3.103"
  ],
  "restart": true,
  "waitForRenewedAvailability": true
},
```

### 23.5.7.3.9 Changing the parameter value (setParameter)

With the setParameter command, you can change the value of a parameter in Script mode. You can execute the command both offline and with an existing online connection.

#### Attributes

- "module": Reference of the module, <binding> <string>
- "reference": Reference of the drive controller, <binding> <string>
- "coordinate": Coordinate of the parameter, <binding> <string>
- "value": Value of the parameter, <binding> <string>

#### Example

```
"setA10[3]:" {
  "command": "setParameter",
  "module": "M1",
  "reference": "T2",
  "coordinate": "A10[3]",
  "value": "2"
},
```

### 23.5.7.3.10 performAction

With the performAction command, you can perform an action in Script mode. You can only execute the command if there is an existing online connection.

#### Attributes

- "reference": Reference of the drive controller, <optional> <string>
  - If the specification is missing, the action is executed on all connected drive controllers
- "module": Reference of the module, <optional> <string>
  - If the specification is missing, the action is executed on all connected drive controllers
- "coordinate": Coordinate of the action parameter, <binding> <string>
- "waitForDone": Wait until the action has been completed, <optional> <Boolean> <default=true>
- "timeout", <optional> <integer><default = 60> (timeout in seconds):
  - If waitForDone is true: If the timeout is reached before the action has been fully completed, the command was unsuccessful and the sequence has been interrupted
  - If waitForDone is false: After the action is started, there is a wait until the timeout has expired; then the sequence is continued; the command is considered successfully processed
- "livingSpace": Axis (in the case of multiple axes, those to which a parameter is assigned), <optional> <string><default=Global>

Possible values:

```
"livingSpace": "Global",
"livingSpace": "Axis1",
"livingSpace": "Axis2",
"livingSpace": "Axis3",
"livingSpace": "Axis4",
```



**Example**

```
"restartSIAx1": {
  "command": "performAction",
  "module": "M1",
  "reference": "SIAx1",
  "coordinate": "A09",
  "livingSpace": "Global",
  "waitForDone": false,
  "timeout": 10
},
```

**23.5.7.3.11 Opening a message (openMessageBox)**

With the openMessageBox command, you can open a message in Script mode that displays the specified text. The command script is stopped until the message is confirmed with OK.

**Attributes**

- "text": text of the message, <binding> <string>

**Example**

```
"ShowMsgBox": {
  "command": "openMessageBox",
  "text": "Please press OK!",
},
```

**23.5.7.3.12 wait**

With the wait command, you can pause the command script in Script mode for the specified time.

**Attribute**

- "seconds": Wait time in seconds, <binding> <integer>

**Example**

```
"Wait15Secs": {
  "command": "wait",
  "seconds": 15
},
```

### 23.5.7.3.13 Exporting parameter values (exportParameter)

With the `exportParameter` command, you can export the parameter values of a drive controller, a module or the entire project in Script mode. If you do not define any specific drive controller or module via the attributes, the parameter values of the entire project are exported. You can work with the variables listed below to have unique file names when exporting the entire project. These are replaced by the actual values during export.

#### Attributes

- `"exportPath"`: Directory to which the parameter values are exported as a text file, <binding> <string>
- `"module"`: Reference of the module, <optional> <string>
- `"reference"`: Reference of the drive controller, <optional> <string>

#### Variables

Variable	Description
%m%	Module reference
%M%	Designation of the module
%r%	Reference of the drive controller
%d%	Designation of the drive controller
%i%	Iteration over the number of drive controllers

Tab. 387: Script mode: Variables for importing and exporting parameters

#### Example

```

"ExportSingle": {
  "command": "exportParameter",
  "module": "M1",
  "reference": "T2",
  "exportPath": "%COMMANDFILE%/parameters_%r%-%d%_ProjectName.txt"
},
,
"ExportMulti": {
  "command": "exportParameter",
  "exportPath": "%COMMANDFILE%/parameters_%r%-%d%_ProjectName.txt"
},
,

```

### 23.5.7.3.14 Importing parameter values (importParameter)

With the `importParameter` command, you can import previously exported parameter values for a drive controller, a module or the entire project in Script mode. If you do not define a specific drive controller or module via the attributes, the parameter values of the entire project are imported. You can work with the variables listed below to have unique file names when exporting the entire project. These are replaced by the actual values during export.

#### Attributes

- `"importPath"`: Path to the text file from which the parameter values are imported, <binding> <string>
- `"module"`: Reference of the module, <optional> <string>
- `"reference"`: Reference of the drive controller, <optional> <string>
- `"deleteAfter"`: If true, the text file with the parameter values will be deleted after import <optional> <Boolean><default = true>
- `"reportPath"`: Path under which the change overview (\*.html) is saved, <binding> <string>

#### Variables

Variable	Description
%m%	Module reference
%M%	Designation of the module
%r%	Reference of the drive controller
%d%	Designation of the drive controller
%i%	Iteration over the number of drive controllers

Tab. 388: Script mode: Variables for importing and exporting parameters

#### Example

```

"ImportSingle": {
  "command": "importParameter",
  "module": "M1",
  "reference": "T2",
  "importPath": "%COMMANDFILE%/parameters_%r%-%d%_ProjectName.txt",
  "reportPath": "%COMMANDFILE%/parameterImportReport_ ProjectName.html",
  "deleteAfter": false
},
,
"ImportMulti": {
  "command": "importParameter",
  "importPath": "%COMMANDFILE%/parameters_%r%-%d%_ProjectName.txt",
  "reportPath": "%COMMANDFILE%/parameterImportReport_ ProjectName.html",
  "deleteAfter": false
},
,

```

### 23.5.7.3.15 updateTemplates

With the updateTemplates command, you can update the project configuration of the drive controllers to the latest version in Script mode (templates and system parameter version).

#### Attributes

- "reportPath": Generates an overview (\*.html) of the changes in the project configuration, <optional> <string>

#### Example

```
"updateTemplates": {  
  "command": "updateTemplates",  
  "reportPath": "%COMMANDFILE%/updateReport.html"  
},
```

### 23.5.7.3.16 Creating reverse documentation (takeSnapshot)

With the takeSnapshot command, you can establish an online connection in Script mode to read out the configurations of the connected drive controllers into the project and to create reverse documentation when disconnecting. The configurations are read out into a new module in the project tree. If you do not use the attributes to specify any specific drive controllers, the configuration is read out for all drive controllers in the network and reverse documentation is created.

IGBs are always read out completely. If no project is open, the command creates a new, empty project.

#### Attributes

- "ipAddresses": List of IP addresses of the drive controllers at the gateways, <optional> <string array>
- "serialNumbers": List of production numbers of the drive controllers at the gateways, <optional> <integer array>
- "references": List of references of the drive controllers at the gateways, <optional> <string array>

#### Information

During the search, all drive controllers within the broadcast domain are found via IPv4 limited broadcast.

Requirements for finding a drive controller in the network:

- Network supports IPv4 limited broadcast
- All drive controllers and the PC are in the same subnet (broadcast domain)

#### Description

The command establishes a direct connection to the gateway drive controllers with the corresponding IP addresses, production numbers or references.

Establishing a connection using Internet remote maintenance or LAN-based remote maintenance is not supported.

#### Example 1

```
"takeSnapshot": {
  "command": "takeSnapshot"
},
```

#### Example 2

```
"takeSnapshotIpAddresses": {
  "command": "takeSnapshot",
  "ipAddresses": ["192.168.3.4", "192.168.3.139"]
},
```

#### Example 3

```
"takeSnapshotReferences": {
  "command": "takeSnapshot",
  "references": ["T3", "T4"]
},
```

#### Example 4

```
"takeSnapshotSerialNumbers": {
  "command": "takeSnapshot",
  "serialNumbers": [9011564, 9012296]
},
```

### 23.5.7.3.17 Deleting reverse documentation (discardReverseDocumentation)

With the `discardReverseDocumentation` command, you can delete one or all instances of reverse documentation in Script mode. If you do not define any specific drive controller via the attributes, the reverse documentation of all drive controllers in the project is deleted.

#### Attributes

- "reference": Reference of the drive controller, <optional> <string>
- "module": Reference of the module, <optional> <string>

#### Example

```
"discardReverseDocu": {
  "command": "discardReverseDocumentation",
  "reference": "T1"
  "module": "M1"
},
```

### 23.5.7.4 Executing a command script

To execute a command script, in addition to the actual script, you need a batch file with which you pass the command script to DriveControlSuite. You can execute the command script either when DriveControlSuite is opened from the DriveControlSuite – Script mode window or when DriveControlSuite is closed by double-clicking on the corresponding batch file.

#### Information

Place all the files you need to execute a command script in the same directory. To execute a command script, you need at least 2 files (command script and batch file). If you want to log the script execution, you also need a log file. Depending on the application, you may also need a project file if you want to create or import a backup, for example.

#### Information

For application examples for the Script mode, go to the STOBER Download Center at <http://www.stoeber.de/en/downloads/> and search for `Script mode`. The application examples contain sample files for the 3 following use cases: update firmware (firmware update), save configuration (backup) and import configuration (restore). You can adapt the sample files to your application by changing the number and addressing of the drive controllers and also the file names and path specifications.

### Creating a command script

Create a command script (\*.json) that contains the appropriate commands and attribute values for your application.

- ✓ You are in the directory for the command script files.
- 1. Create a new text file via the Windows Explorer context menu.
- 2. Assign a suitable file name and change the file extension from \*.txt to \*.json.
  - 2.1. Example: `FirmwareUpdate.json`.
- 3. Open the file.
- 4. Write the command script for your application by defining the settings, sequence and commands script sections.

## 4.1. Example:

```
{
  "settings": {
    "logFilePath": "%COMMANDFILE%/FirmwareUpdate.log",
    "quitWhenDone": "never"
  },
  "sequence": [
    "UpdateFirmware"
  ],
  "UpdateFirmware": {
    "command": "updateFirmware",
    "firmware": "V 6.4-D",
    "ipAddresses":
      [ "200.0.0.1",
        "200.0.0.2",
        "200.0.0.3"
      ],
    "restart": true
  }
}
```

5. Save the command script.

### Creating a batch file

Create a batch file (\*.bat) with which you pass the command script to DriveControlSuite.

- ✓ You are in the directory for the command script files.

1. Create a new text file via the Windows Explorer context menu.
2. Assign a suitable file name and change the file extension from \*.txt to \*.bat.

2.1. Example: FirmwareUpdate.bat.

3. Open the file.
4. Specify the path to the EXE file of DriveControlSuite and assign the command script.

## 4.1. Example:

```
"C:\Program Files (x86)\STOBER\DriveControlSuite\bin\DS6A.exe"  
FirmwareUpdate.json
```

5. Save the batch file.

### Executing a command script

Execute a command script with DriveControlSuite closed or open.

- ✓ You are in DriveControlSuite.
- 1. Use the keyboard shortcut [Ctrl] + [F9].
  - ⇒ The DriveControlSuite – Script mode window opens.
- 2. Click Load file.
  - ⇒ The Open file dialog box opens.
- 3. Navigate to the desired command script and click Open.
- 4. To run the command script, click Run.
  - ⇒ The command script will be executed.
  - ⇒ The DriveControlSuite – Script mode window displays information about the status of the command script in the Overview, Messages and Log file areas.

#### Information

You can execute a command script even when DriveControlSuite is closed by double-clicking the associated batch file. Double-clicking the batch file executes the command script and the DriveControlSuite - Script Mode window will open to display information about the status of the command script.

### 23.5.7.5 Presetting connections

You need the presets for the connection setup for the setOnlineByPreset command in Script mode. If you store presets for the connection setup in the project, you can easily store a command script or reuse it for multiple projects.

- ✓ You are in DriveControlSuite.
- ✓ Your project is open.
- 1. Select the project in the project tree and choose Preset connections from the context menu.
  - ⇒ The Preset connections window opens.
- 2. Direction selection:  
Select whether read or send access to the drive controllers is to be made when the connection is established.
- 3. Target selection:  
Select how the configuration and drive controller are to be assigned to each other when the connection is established (IP address, reference, production number, PLC device name).
- 4. Confirm the presets with OK.
  - ⇒ The presets are taken into account in the next execution of the setOnlineByPreset command.



### 23.5.7.6 Application examples for EtherCAT

Examples are provided to illustrate how Script mode functions and how you can use it.

The files required for running the application examples can be found at <http://www.stoeber.de/en/downloads/>. Enter `Script mode` in the search field.

The package contains the example files for the following actions:

- Carry out a firmware update (FirmwareUpdate) (also refer to Running a script).
- Load the prepared configuration (Restore)
- Saving the current configuration (Backup)

The requirements for executing the actions are almost identical for all example files (see Running a script).

If you would like to use the example files, you must adapt them (file names and paths, addressing of the drive controllers).

#### Test setup

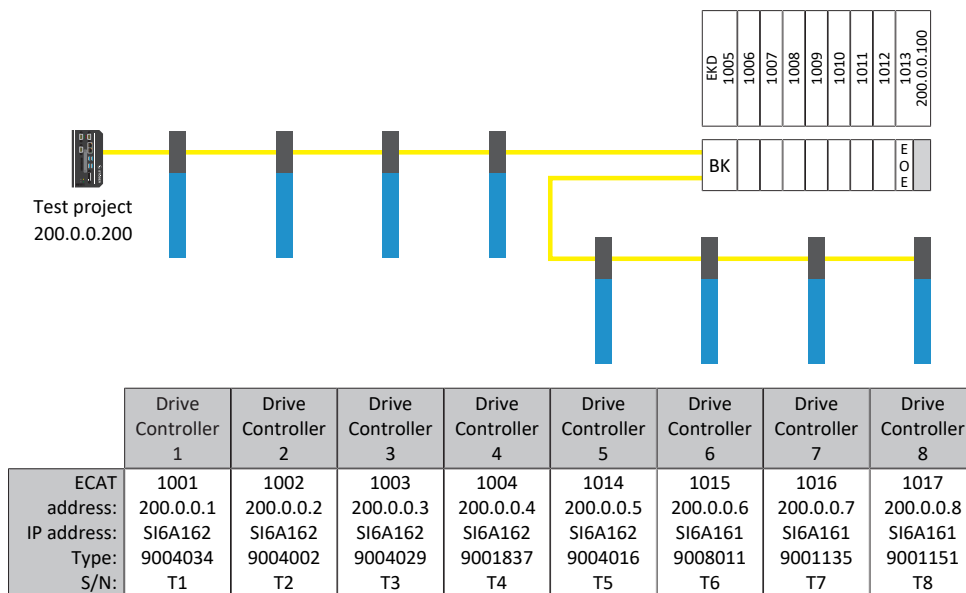

Fig. 101: Test setup of the application examples

Eight drive controllers of the SI6 series with fixed IP addresses 200.0.0.1 - 200.0.0.8 assigned by the EtherCAT master.

#### Variante 1

The DriveControlSuite runs on the same IPC as the EtherCAT master.

#### Variante 2

The DriveControlSuite runs on a PC or laptop. The PC or laptop are on the same network as the IPC, but not on the same network as the EoE device group. A route must also be set here. For more information, see [Network route \[▶ 467\]](#).

### 23.5.7.6.1 Carrying out a firmware update

#### Requirements

- DriveControlSuite version 6.4-D or later is the default installation
- All drive controllers are operated with firmware version 6.4-A or later
- All drive controllers can be reached through a direct connection using IP addresses 200.0.0.1 to 200.0.0.8

#### Behavior of the script

The script for the drive controllers with the IP addresses 200.0.0.1 - 200.0.0.8 transfers a firmware update to firmware version 6.4-D. The drive controllers are then restarted.

<b>Information</b>
--------------------

Be aware that values that have been changed or only stored in volatile memory are lost and that fieldbus communication and the connection to DriveControlSuite are interrupted in the event of a drive controller restart.

### 23.5.7.6.2 Load the prepared configuration (Restore)

#### Requirements

- DriveControlSuite version 6.4-D or later is the default installation
- All drive controllers are operated with firmware version 6.4-A or later
- All drive controllers can be reached through a direct connection using IP addresses 200.0.0.1 to 200.0.0.8
- A project file Restore.ds6 with the drive controllers

#### Behavior of the script

The configurations of the drive controllers projected in the Restore.ds6 project are transferred to the drive controllers with the parameterized IP addresses by a script.

<b>Information</b>
--------------------

Be aware that values that have been changed or only stored in volatile memory are lost and that fieldbus communication and the connection to DriveControlSuite are interrupted in the event of a drive controller restart.

<b>ATTENTION!</b>
-------------------

**Machine damage from uncontrolled stopping!**

Note that sending a configuration includes a brief stop of the device configuration. Communication with the EtherCAT master is interrupted. For this reason, the script may be run only in the pre-operational state.

### 23.5.7.6.3 Saving the current configuration (Backup)

#### Requirements

- DriveControlSuite version 6.4-D or later is the default installation
- All drive controllers are operated with firmware version 6.4-A or later
- All drive controllers can be reached through a direct connection using IP addresses 200.0.0.1 to 200.0.0.8
- A project file Backup.ds6 with the drive controllers.

#### Behavior of the script:

The configurations of the drive controllers with the parameterized IP addresses are saved in the Backup.ds6 file by a script.

### 23.5.7.6.4 Network route

The Internet Protocol (IP) ensures that data packets are communicated across network boundaries. Routing is the determination of a suitable path for transferring the data packets.

Particularly when EoE is used, it is often necessary to create a route manually.

#### Information

Note that manually routing to the controller will function only if the IP address of the controller and the IP address of the PC in question are in the same network. Otherwise, the network administration has to add a static route to the router's routing table.

#### Creating a network route

In Windows, the route is created as follows:

```
route ADD 200.0.0.0 MASK 255.0.0.0 192.168.12.36
```

Explanation:

200.0.0.0 is the EoE network with a network mask of 255.0.0.0.

192.168.12.36 is the address of the controller that connects to the EoE network.

#### Deleting a network route

In Windows, the route is deleted as follows:

```
route delete 200.0.0.0
```

### 23.5.7.7 Exit statuses

Calling a command script returns the exit statuses described below, which can be output on a Windows PC using the command prompt, for example. The exit status for the successful execution of a command script is 0. An exit status not equal to 0 signals an error.

Exit status	Name	Description or cause	Check and action
0	SUCCESS	Command script was executed without errors	—
100	JSON-ERROR	Error parsing the command script	Check syntax of JSON file and correct if necessary
101	JSON-FILE-NOT-EXISTING	Command script was not found	Check assignment of the command script in the batch file and correct if necessary
201	PROJECT-FILE-NOT-EXISTING	Project file was not found	Check attributes in the command script and correct if necessary
202	PROJECT-FILE-NOT-OPENING	Project file could not be opened	Check whether the DS6 project is already open and close it if necessary
203	PROJECT-FILE-NOT-READABLE	Project file was not readable	Check read access rights to the DS6 project and extend them if necessary
204	PROJECT-FILE-WRONG-FW	Project file could not be loaded due to wrong firmware; firmware version of the project file does not match the DriveControlSuite	Check firmware version in DS6 project and correct if necessary
210	CANNOT-SAVE-PROJECT-FILE	Project file could not be saved	Check write access rights to the DS6 project and extend them if necessary
300	CONNECTION-ERROR	Error when establishing a connection	Check network connection; check attributes in the command script and correct if necessary
400	SETONLINE-ERROR	Error during online connection if the error cannot be narrowed down more precisely	Check attributes in the command script and correct if necessary
401	SETONLINE-ERROR-READING	Error with read online connection	Check attributes in the command script and correct if necessary
402	SETONLINE-ERROR-WRITING	Error with write online connection	Check attributes in the command script and correct if necessary
500	FWUPDATE-ERROR	Error during firmware update if the error cannot be narrowed down more precisely	Check attributes in the command script and correct if necessary
501	FWUPDATE-FILE-NOT-FOUND	Error during firmware update if the firmware file was not found	Check attributes in the command script and correct if necessary
502	FWUPDATE-CONTROLLER-NOT-FOUND	Error during firmware update if the drive controller was not found	Check attributes in the command script and correct if necessary
601	PARAIMPORT-FILE-NOT-FOUND	Error during parameter import if the import file was not found	Check attributes in the command script and correct if necessary
602	PARAEXPORT-FILE-NOT-WRITABLE	Error during parameter export if the file could not be written	Check access rights to the directory and file and extend them if necessary
700	ACTION-ERROR	Error when performing an action if the error cannot be narrowed down more precisely	Check attributes in the command script and correct if necessary

Exit status	Name	Description or cause	Check and action
701	ACTION-WRONG-PARAMETER	Error while executing an action if the parameter coordinate was wrong	Check attributes in the command script and correct if necessary
800	SET-PARAMETER-ERROR	Error when writing a parameter value if the error cannot be narrowed down more precisely	Check attributes in the command script and correct if necessary
801	SET-PARAMETER-NOT-WRITABLE	Error when writing a parameter value if the parameter is write-protected	Parameter value cannot be changed; check attributes in the command script and change parameter coordinate if necessary
802	SET-PARAMETER-NOT-EXISTING	Error writing a parameter value if the parameter does not exist	Check attributes in the command script and correct if necessary
900	UPDATE-TEMPLATES-ERROR	Error when updating a template	Check project configuration of the drive controllers for compatibility with the latest version of the templates
1100	SNAPSHOT-ERROR	Error when creating reverse documentation	Check attributes in the command script and correct if necessary
1150	DISCARD-SNAPSHOT-ERROR	Error when deleting reverse documentation	Check attributes in the command script and correct if necessary
1200	ONLINE-BY-PRESET-ERROR	Error during online connection according to the default settings	Check network connection; check attributes in the command script and correct if necessary
1300	START-SAFETY-TOOL-ERROR	Error when starting PASmotion	If necessary, reinstall DriveControlSuite with PASmotion

Tab. 389: Script mode: Exit statuses

### Extending a batch file

The exit status can be queried with the following command:

```
echo %ERRORLEVEL%
```

The following example shows the content of a batch file (\*.bat), extended by the output of the exit status in the penultimate line:

```
echo off
"C:\Program Files (x86)\STOBER\DriveControlSuite\bin\DS6A.exe" FirmwareUpdate.json
IF %ERRORLEVEL% NEQ 0 Echo An error was found:
IF %ERRORLEVEL% EQU 0 Echo No error found:
echo %ERRORLEVEL%
pause
```

## 23.5.8 Information for SSI encoders

The following chapters provide you with more detailed information on setting SSI encoders with the help of the DriveControlSuite commissioning software.

### 23.5.8.1 SSI encoder at X4 with free setting (H00 = 78)

Obey the instructions described below if you use X4 as the connection for SSI encoders and want to use the free setting option for the encoder function (H00 = 78: SSI free setting).

<b>Information</b>
--------------------

The free setting of SSI encoders is supported by drive controllers in firmware V 6.5-G or higher.

#### Notes on settings for rotational single-turn SSI encoders at X4

1. The number of data bits corresponds to the sum of the single-turn bits and alarm bit of the encoder (H14 = number of single-turn bits + alarm bit)
2. Set mechanical value to 1 revolution (H121 = 1)
3. Set raw encoder value to  $2^{\text{Number of single-turn bits (encoder)}}$  (H122 =  $2^{\text{number of single-turn bits}}$ )

#### Notes on settings for rotational multi-turn SSI encoders at X4

1. The number of data bits corresponds to the sum of the multi-turn bits, single-turn bits and alarm bit of the encoder (H14 = number of single-turn bits + number of multi-turn bits + alarm bit)
2. Set mechanical value to 1 revolution (H121 = 1)
3. Set raw encoder value to  $2^{\text{Number of single-turn bits (encoder)}}$  (H122 =  $2^{\text{number of single-turn bits}}$ )

#### Notes on settings for translational SSI encoders at X4

1. The number of data bits corresponds to the number of position bits and alarm bit of the encoder (H14 = number of position bits + alarm bit)
2. Set mechanical value to measuring range (H121 = measuring range)
3. For the raw encoder value, store the number of increments of the measuring range (H122)

#### Interpretation

The interpretation of the data bits as the position is carried out using the H01 and H02 parameters.

#### Relationship between resolution, clock frequency and double transmission in SSI encoders

Ideally, a new, valid position value in high resolution is available in every cycle of the control.

With a higher resolution of the position value, the amount of data to be transmitted (H14) increases and thus so does the transmission time. The same applies if the position is read out twice to enable better detection of transmission errors (H11) for increasing data security.

The transmission time of the position value should not exceed the cycle time of the control. To compensate for the increased transmission time, you can transmit the bits at a higher clock frequency (H15) if the SSI encoder supports this function. From approx. 600 kHz, cable lengths of 100 m are no longer possible.

### 23.5.8.2 SSI encoder at X4 (H00 = 65)

Obey the instructions described below if you use X4 as the connection for SSI encoders and use the setting H00 = 65: SSI for the function of the encoder.

#### Notes on settings for rotational single-turn SSI encoders at X4

1. If possible, set the number of data bits equal to the number of single-turn bits of the encoder (H10);  
If none of the available data bit options are identical to the number of single-turn bits, then use the next largest data bit option; if the number of single-turn bits is larger than the largest available data bit option, then use the largest available data bit option
2. Set mechanical value to 1 revolution (H01 = 1)
3. Set raw encoder value to  $2^{\text{Number of data bits (H10)}}$  (H02 =  $2^{\text{H10}}$ )

#### Notes on settings for rotational multi-turn SSI encoders at X4

1. If possible, set the number of data bits equal to the sum of the number of multi-turn and single-turn bits of the encoder (H10);  
If none of the available data bit options are identical to the sum, then use the next largest data bit option; if the sum is larger than the largest available data bit option, then use the largest available data bit option
2. Set mechanical value to 1 revolution (H01 = 1)
3. Set raw encoder value to  $2^{\text{Number of data bits (H10) - Number of multi-turn bits (encoder)}}$  (H02 =  $2^{\text{H10 - Number of multi-turn bits}}$ )

Number of single-turn bits	Number of multi-turn bits	Guide value H10	Guide value H01	Guide value H02
Up to 12	–	2: 13 bit short	1	$8192 = 2^{13}$
13	–	2: 13 bit short	1	$8192 = 2^{13}$
14 – 23	–	1: 24	1	$16777216 = 2^{24}$
24	–	1: 24	1	$16777216 = 2^{24}$
25	–	0: 25	1	$33554432 = 2^{25}$
Starting from 26	–	0: 25	1	$33554432 = 2^{25}$
12	12	1: 24	1	$4096 = 2^{24 - 12} = 2^{12}$
13	12	0: 25	1	$8192 = 2^{25 - 12} = 2^{13}$
14	12	0: 25	1	$8192 = 2^{25 - 12} = 2^{13}$
13	13	0: 25	1	$4096 = 2^{25 - 13} = 2^{12}$
13	14	0: 25	1	$2048 = 2^{25 - 14} = 2^{11}$

Tab. 390: Examples of rotational SSI encoders at X4

**Notes on settings for translational SSI encoders at X4**

1. If possible, set the number of data bits equal to the number of position bits of the encoder (H10);  
If none of the available data bit options are identical to the number of position bits, then use the next largest data bit option; if the number of position bits is larger than the largest available data bit option, then use the largest available data bit option
2. If the number of position bits is less than or equal to the data bit option, then set the mechanical value to the distance per 1 LSB of the encoder(H01);  
If the number of position bits is greater than the data bit option, then set the mechanical value to the distance per  $2^{\text{number of position bits (encoder)} - \text{number of data bits (H10)}}$  LSB of the encoder (H01)
3. If the number of position bits is less than the data bit option, then set the raw encoder value to  $2^{\text{number of data bits (H10)} - \text{number of position bits (encoder)}}$  (H02 =  $2^{\text{H10}}$ );  
If the number of position bits is greater than or equal to the data bit option, then set the raw encoder value to 1 (H02 = 1)

Number of position bits	Guide value H10	Guide value H01	Guide value H02
12	2: 13 bit short	mm per 1 LSB	$2 = 2^{13 - 12 = 1}$
13	2: 13 bit short	mm per 1 LSB	1
14	1: 24	mm per 1 LSB	$1024 = 2^{24 - 14 = 10}$
15	1: 24	mm per 1 LSB	$512 = 2^{24 - 15 = 9}$
24	1: 24	mm per 1 LSB	1
25	0: 25	mm per 1 LSB	1
26	0: 25	mm per 2 LSB ( $2^{26 - 25 = 1} = 2$ )	1

Tab. 391: Examples of translational SSI encoders at X4

**Interpretation**

The interpretation of the data bits as the position is carried out using the H01 and H02 parameters.

**Relationship between resolution, clock frequency and double transmission in SSI encoders**

Ideally, a new, valid position value in high resolution is available in every cycle of the control.

With a higher resolution of the position value, the amount of data to be transmitted (H10) increases and thus so does the transmission time. The same applies if the position is read out twice to enable better detection of transmission errors (H11) for increasing data security.

The transmission time of the position value should not exceed the cycle time of the control. To compensate for the increased transmission time, you can transmit the bits at a higher clock frequency (H06) if the SSI encoder supports this function and the cable length permits it.



### 23.5.8.3 SSI encoder at X120 with free setting (H120 = 76 or 83)

Obey the instructions described below if you use X120 on a XI6 or RI6 terminal module as the connection for SSI encoders and want to use the free setting option for the encoder function (H120 = 76: SSI free setting or 83: SSI simulation free setting).

<b>Information</b>
--------------------

The prerequisite for the free setting of SSI encoders is a hardware level  $\geq 14$  for the XI6 option and a hardware level  $\geq 8$  for the RI6 option.

#### Notes on settings for rotational single-turn SSI encoders at X120 with free adjustment

1. The number of data bits corresponds to the sum of the single-turn bits and alarm bit of the encoder (H134 = number of single-turn bits + alarm bit)
2. Set mechanical value to 1 revolution (H121 = 1)
3. Set raw encoder value to  $2^{\text{Number of single-turn bits (encoder)}}$  (H122 =  $2^{\text{number of single-turn bits}}$ )

#### Notes on settings for rotational multi-turn SSI encoders at X120 with free adjustment

1. The number of data bits corresponds to the sum of the multi-turn bits, single-turn bits and alarm bit of the encoder (H134 = number of single-turn bits + number of multi-turn bits + alarm bit)
2. Set mechanical value to 1 revolution (H121 = 1)
3. Set raw encoder value to  $2^{\text{Number of single-turn bits (encoder)}}$  (H122 =  $2^{\text{number of single-turn bits}}$ )

#### Notes on settings for translational SSI encoders at X120 with free adjustment

1. The number of data bits corresponds to the number of the position bits and alarm bit of the encoder (H134 = position bits + alarm bit)
2. Set mechanical value to measuring range (H121 = measuring range)
3. For the raw encoder value, store the number of increments of the measuring range (H122)

#### Interpretation

The interpretation of the data bits as the position is carried out using the H121 and H121 parameters.

#### Relationship between resolution, clock frequency and double transmission in SSI encoders

Ideally, a new, valid position value in high resolution is available in every cycle of the control.

With a higher resolution of the position value, the amount of data to be transmitted (H134) increases and thus so does the transmission time. The same applies if the position is read out twice to enable better detection of transmission errors (H128) for increasing data security.

The transmission time of the position value should not exceed the cycle time of the control. To compensate for the increased transmission time, you can transmit the bits at a higher clock frequency (H135) if the SSI encoder supports this function. From approx. 600 kHz, cable lengths of 100 m are no longer possible.

### 23.5.8.4 SSI encoder at X120 (H120 = 67)

Follow the setting instructions described below if you want to use X120 on a XI6 or RI6 terminal module as the connection for SSI encoders and use the setting H120 = 67: SSI for the encoder function.

#### Notes on settings for rotational single-turn SSI encoders at X120

1. If possible, set the number of data bits equal to the number of single-turn bits of the encoder (H126);  
If none of the available data bit options are identical to the number of single-turn bits, then use the next largest data bit option; if the number of single-turn bits is larger than the largest available data bit option, then use the largest available data bit option
2. Set mechanical value to 1 revolution (H121 = 1)
3. Set raw encoder value to  $2^{\text{Number of data bits (H126)}}$  (H122 =  $2^{\text{H126}}$ )

#### Notes on settings for rotational multi-turn SSI encoders at X120

1. If possible, set the number of data bits equal to the sum of the number of multi-turn and single-turn bits of the encoder (H126);  
If none of the available data bit options are identical to the sum, then use the next largest data bit option; if the sum is larger than the largest available data bit option, then use the largest available data bit option
2. Set mechanical value to 1 revolution (H121 = 1)
3. Set raw encoder value to  $2^{\text{Number of data bits (H126) - Number of multi-turn bits (encoder)}}$  (H122 =  $2^{\text{H126 - Number of multi-turn bits}}$ )

Number of single-turn bits	Number of multi-turn bits	Guide value H126	Guide value H121	Guide value H122
Up to 12	–	2: 13 bit short	1	$8192 = 2^{13}$
13	–	2: 13 bit short	1	$8192 = 2^{13}$
14 – 23	–	1: 24	1	$16777216 = 2^{24}$
24	–	1: 24	1	$16777216 = 2^{24}$
25	–	0: 25	1	$33554432 = 2^{25}$
Starting from 26	–	0: 25	1	$33554432 = 2^{25}$
12	12	1: 24	1	$4096 = 2^{24 - 12} = 2^{12}$
13	12	0: 25	1	$8192 = 2^{25 - 12} = 2^{13}$
14	12	0: 25	1	$8192 = 2^{25 - 12} = 2^{13}$
13	13	0: 25	1	$4096 = 2^{25 - 13} = 2^{12}$
13	14	0: 25	1	$2048 = 2^{25 - 14} = 2^{11}$

Tab. 392: Examples of rotational SSI encoders at X120

### Notes on settings for translational SSI encoders at X120

1. If possible, set the number of data bits equal to the number of position bits of the encoder (H126);  
If none of the available data bit options are identical to the number of position bits, then use the next largest data bit option; if the number of position bits is larger than the largest available data bit option, then use the largest available data bit option
2. If the number of position bits is less than or equal to the data bit option, then set the mechanical value to the distance per 1 LSB of the encoder(H121);  
If the number of position bits is greater than the data bit option, then set the mechanical value to the distance per  $2^{\text{number of position bits (encoder)} - \text{number of data bits (H126)}}$  LSB of the encoder (H121)
3. If the number of position bits is less than the data bit option, then set the encoder raw value to  $2^{\text{number of data bits (H126)} - \text{number of position bits (encoder)}}$  (H122 =  $2^{\text{H126}}$ );  
If the number of position bits is greater than or equal to the data bit option, then set the encoder raw value to 1 (H122 = 1)

Number of position bits	Guide value H126	Guide value H121	Guide value H122
12	2: 13 bit short	mm per 1 LSB	$2 = 2^{13 - 12 = 1}$
13	2: 13 bit short	mm per 1 LSB	1
14	1: 24	mm per 1 LSB	$1024 = 2^{24 - 14 = 10}$
15	1: 24	mm per 1 LSB	$512 = 2^{24 - 15 = 9}$
24	1: 24	mm per 1 LSB	1
25	0: 25	mm per 1 LSB	1
26	0: 25	mm per 2 LSB ( $2^{26 - 25 = 1} = 2$ )	1

Tab. 393: Examples of translational SSI encoders at X120

### Interpretation

The interpretation of the data bits as the position is carried out using the H121 and H121 parameters.

### Relationship between resolution, clock frequency and double transmission in SSI encoders

Ideally, a new, valid position value in high resolution is available in every cycle of the control.

With a higher resolution of the position value, the amount of data to be transmitted (H126) increases and thus so does the transmission time. The same applies if the position is read out twice to enable better detection of transmission errors (H128) for increasing data security.

The transmission time of the position value should not exceed the cycle time of the control. To compensate for the increased transmission time, you can transmit the bits at a higher clock frequency (H127) if the SSI encoder supports this function and the cable length permits it.

## 23.6 Detailed information

The documentation listed below provides you with further relevant information on the 6th STOBER drive controller generation. You can find the current status of the documentation in the STOBER download center at <http://www.stoeber.de/en/downloads/>, if you enter the ID of the documentation in the search.

The grouping of the documentation is intended to provide you with assistance, but is only relevant if you control the drive controller using a fieldbus.

### PROFINET

Title	Documentation	Contents	ID
PROFINET communication – SD6	Manual	Installation, electrical installation, data transfer, commissioning, detailed information	442710
Drive Based (DB) application	Manual	Project planning, configuration, parameterization, function test, detailed information	442706
Drive Based Synchronous (DBS) application	Manual	Project planning, configuration, parameterization, function test, detailed information	443046
ST6 safety technology – STO via terminals	Manual	Technical data, installation, commissioning, diagnostics, detailed information	442478
SE6 safety technology – Safe drive monitoring via terminals	Manual	Technical data, installation, commissioning, diagnostics	442796
Connection method	Manual	Selection of encoder, power and hybrid cables, accessories, technical data, connection	443102

### EtherCAT

Title	Documentation	Contents	ID
EtherCAT communication – SD6	Manual	Installation, electrical installation, data transfer, commissioning, detailed information	442516
CiA 402 application – SD6	Manual	Project planning, configuration, parameterization, function test, detailed information	443077
Drive Based (DB) application	Manual	Project planning, configuration, parameterization, function test, detailed information	442706
Drive Based Synchronous (DBS) application	Manual	Project planning, configuration, parameterization, function test, detailed information	443046
ST6 safety technology – STO via terminals	Manual	Technical data, installation, commissioning, diagnostics, detailed information	442478
SE6 safety technology – Safe drive monitoring via terminals	Manual	Technical data, installation, commissioning, diagnostics	442796

**CANopen**

Title	Documentation	Contents	ID
CANopen communication – SD6	Manual	Installation, electrical installation, data transfer, commissioning, detailed information	442637
CiA 402 application – SD6	Manual	Project planning, configuration, parameterization, function test, detailed information	443077
Drive Based (DB) application	Manual	Project planning, configuration, parameterization, function test, detailed information	442706
Drive Based Synchronous (DBS) application	Manual	Project planning, configuration, parameterization, function test, detailed information	443046
ST6 safety technology – STO via terminals	Manual	Technical data, installation, commissioning, diagnostics, detailed information	442478
SE6 safety technology – Safe drive monitoring via terminals	Manual	Technical data, installation, commissioning, diagnostics	442796
Connection method	Manual	Selection of encoder, power and hybrid cables, accessories, technical data, connection	443102

## 23.7 Symbols in formulas

Symbol	Unit	Explanation
$C_{1\max}$	F	Maximum input capacitance
$C_{N,PU}$	F	Nominal charging capacity of the power unit
$C_{PU}$	F	Self-capacitance of the power unit
$D_{IA}$	%	Reduction in the nominal current depending on the installation altitude
$D_T$	%	Reduction in the nominal current depending on the surrounding temperature
$E_{2\max}$	J	Maximum switch-off energy at the output
$f_{1\max}$	Hz	Maximum input frequency
$f_{2\max}$	Hz	Maximum output frequency
$f_{2PU}$	Hz	Output frequency of the power unit
$f_N$	Hz	Rotating magnetic field frequency at nominal speed
$f_{PWM,PU}$	Hz	Frequency of the pulse width modulation of the power unit
$I_0$	A	Stall current
$I_{1\max}$	A	Maximum input current
$I_{1\max CU}$	A	Maximum input current of the control unit
$I_{1\max PU}$	A	Maximum input current of the power unit
$I_{1N,PU}$	A	Nominal input current of the power unit
$I_{1N,PU\min}$	A	Nominal input current of the power unit from the smallest drive controller connected to the grid
$I_{2\max}$	A	Maximum output current
$I_{2\max PU}$	A	Maximum output current of the power unit
$I_{2\min}$	A	Minimum output current
$I_{2N,PU}$	A	Nominal output current of the power unit
$I_{d,ref}$	A	Magnetization-generating reference current in the d/q coordinate system
$I_{LINE}$	A	Supply current
$I_{\max LINE}$	A	Maximum supply current
$I_{\min LINE}$	A	Required supply current
$I_N$	A	Nominal current
$I_{N,MF}$	A	Nominal current of the choke or motor filter
$I_{q,ref}$	A	Torque/force-generating reference current in the d/q coordinate system
$K_I$	—	Integral coefficient
$K_P$	—	Proportional coefficient
$\lambda_{LINE}$	—	Power factor of the supply grid
$M/F_{set}$	Nm/N	Set torque or set force
$M_0$	Nm	Stall torque
$M_{1Bstat}$	Nm	Static braking torque of the brake in the motor adapter (tolerance +40%, -20%)
$M_{2N}$	Nm	Nominal torque on the gear unit output (relative to $n_{1N}$ )
$M_B$	Nm	Braking torque
$M_{Bstat}$	Nm	Static braking torque of the motor brake at 100 °C
$M_k$	Nm	Permitted tilting torque on the output
$M_N$	Nm	Nominal torque
$M_{N,B}$	Nm	Nominal braking torque

Symbol	Unit	Explanation
$MTTF_D$	Year, a	Average time before dangerous failure
$n_{1N}$	rpm	Nominal speed at the gear unit input
$n_{2N}$	$\text{min}^{-1}$	Nominal speed at the gear unit output
$n_{fed}$	–	Number of drive controllers connected to the grid
$n_N$	rpm	Nominal speed: The speed for which the nominal torque $M_N$ is specified
$p$	–	Number of pole pairs
$P_{effRB}$	W	Effective power at the external braking resistor
$P_{LINE}$	W	Power output
$P_{maxRB}$	W	Maximum power at the external braking resistor
$P_{MOT}$	W	Motor rating
$P_{totalMOT}$	W	Total rating of all motors
$P_V$	W	Power loss
$P_{V,CU}$	W	Power loss of the control unit
$R_{2minRB}$	$\Omega$	Minimum resistance of the external braking resistor
$R_{intRB}$	$\Omega$	Resistance of the internal braking resistor
$\vartheta_{amb}$	$^{\circ}\text{C}$	Surrounding temperature
$\vartheta_{amb,max}$	$^{\circ}\text{C}$	Maximum surrounding temperature
$t_{1B}$	ms	Engaging time (also: linking time); time span from when the current is switched off until the nominal holding torque is reached
$t_{2B}$	ms	Release time (also: disengagement time); time span from when the current is switched off until the brake is completely released
$T_M$	Year, a	Mission time
$T_i$	ms	Reset time
$t_{min}$	ms	Minimum cycle time of the application
$\tau_{th}$	$^{\circ}\text{C}$	Thermal time constant
$U_1$	V	Input voltage
$U_{1CU}$	V	Input voltage of the control unit
$U_{1max}$	V	Maximum input voltage
$U_{1PU}$	V	Input voltage of the power unit
$U_2$	V	Output voltage
$U_{2max}$	V	Maximum output voltage
$U_{2PU}$	V	Output voltage of the power unit
$U_{2PU,ZK}$	V	Output voltage of the power unit for the DC link connection (typical values: 400 V <sub>AC</sub> corresponds to 560 V <sub>DC</sub> , 480 V <sub>AC</sub> corresponds to 680 V <sub>DC</sub> )
$U_{max}$	V	Maximum voltage
$U_{maxMOT}$	V	Maximum motor voltage
$U_{MOT}$	V	Motor voltage
$U_{offCH}$	V	Switch-off threshold of the brake chopper
$U_{onCH}$	V	On limit of the brake chopper
$v_{act}$	m/min	Actual velocity
$v_{set}$	m/min	Set velocity
$x_{act}$	m	Actual position
$x_{set}$	m	Set position

## 23.8 Abbreviations

Abbreviation	Meaning
AC	Alternating Current
AEH	Aderendhülse (end sleeve)
AI	Analog Input
AO	Analog Output
AWG	American Wire Gauge
BAT	Battery
BG	Baugröße (size)
CAN	Controller Area Network
CiA	CAN in Automation
CNC	Computerized Numerical Control
DC	Direct Current
DHCP	Dynamic Host Configuration Protocol
DI	Digital Input
DMZ	Demilitarized zone
DO	Digital Output
EMC	Electromagnetic Compatibility
ETG	EtherCAT Technology Group
EtherCAT	Ethernet for Control Automation Technology
HTTP	Hypertext Transfer Protocol
HTL	High Threshold Logic
I/O	Input/Output
IE	International Efficiency
IE class	Energy efficiency class
IP	International Protection
IP	Internet Protocol
MAC	Media Access Control
NAT	Nennansprechtemperatur (nominal response temperature)
P controller	Proportional controller
PE	Protective Earth (grounding conductor)
PELV	Protective Extra Low Voltage
PI controller	Proportional-Integral controller
PID controller	Proportional-Integral-Differential controller
PL	Performance Level
PLC	Programmable Logic Controller
PM	Paramodul
pp	Profile position mode
PRM	Predictive Maintenance
pt	Profile torque mode
PTC	Positive Temperature Coefficient
pv	Profile velocity mode



Abbreviation	Meaning
RCD	Residual Current protective Device
RoHS	Restriction of Hazardous Substances
SBC	Safe Brake Control
SBT	Safe Brake Test
SD	Secure Digital (memory card)
SDI	Safe Direction
S/FTP	Screened/Foiled Twisted Pair
SF/FTP	Screened Foiled/Foiled Twisted Pair
SF/UTP	Screened Foiled/Unshielded Twisted Pair
SIL	Safety Integrity Level
SLI	Safely-Limited Increment
SLS	Safely-Limited Speed
PLC	Programmable Logic Controller
SS1	Safe Stop 1
SS2	Safe Stop 2
SSI	Serial Synchronous Interface
STO	Safe Torque Off
TCP	Transmission Control Protocol
TTL	Transistor-Transistor Logic
UDP	User Data Protocol
UL	Underwriters Laboratories
W&S	Wake and Shake

## 24 Contact

### 24.1 Consultation, service and address

We would be happy to help you!

We offer a wealth of information and services to go with our products on our website:

<http://www.stoeber.de/en/service>

For additional or personalized information, contact our consultation and support service:

<http://www.stoeber.de/en/support>

If you need our system support:

Phone +49 7231 582-3060

systemsupport@stoeber.de

If you need a replacement device:

Phone +49 7231 582-1128

replace@stoeber.de

Call our 24-hour service hotline:

Phone +49 7231 582-3000

Our address:

STÖBER Antriebstechnik GmbH + Co. KG

Kieselbronner Strasse 12

75177 Pforzheim, Germany

### 24.2 Your opinion is important to us

We created this documentation to the best of our knowledge with the goal of helping you build and expand your expertise productively and efficiently with our products.

Your suggestions, opinions, wishes and constructive criticism help us to ensure and further develop the quality of our documentation.

If you want to contact us for a specific reason, we would be happy to receive an e-mail from you at:

documentation@stoeber.de

Thank you for your interest.

Your STÖBER editorial team

## 24.3 Close to customers around the world

We offer you committed, expert advise and support in over 40 countries worldwide:

<b>STOBER AUSTRIA</b> <a href="http://www.stoeber.at">www.stoeber.at</a> Phone +43 7613 7600-0 <a href="mailto:sales@stoeber.at">sales@stoeber.at</a>	<b>STOBER CHINA</b> <a href="http://www.stoeber.cn">www.stoeber.cn</a> Phone +86 10 6590 7391 <a href="mailto:sales@stoeber.cn">sales@stoeber.cn</a>
<b>STOBER FRANCE</b> <a href="http://www.stoeber.fr">www.stoeber.fr</a> Phone +33 4 78.98.91.80 <a href="mailto:sales@stoeber.fr">sales@stoeber.fr</a>	<b>STOBER Germany</b> <a href="http://www.stoeber.de">www.stoeber.de</a> Phone +49 4 7231 582-0 <a href="mailto:sales@stoeber.de">sales@stoeber.de</a>
<b>STOBER ITALY</b> <a href="http://www.stoeber.it">www.stoeber.it</a> Phone +39 02 93909570 <a href="mailto:sales@stoeber.it">sales@stoeber.it</a>	<b>STOBER JAPAN</b> <a href="http://www.stoeber.co.jp">www.stoeber.co.jp</a> Phone +81 3 5395 6788 <a href="mailto:sales@stoeber.co.jp">sales@stoeber.co.jp</a>
<b>STOBER SWITZERLAND</b> <a href="http://www.stoeber.ch">www.stoeber.ch</a> Phone +41 56 496 96 50 <a href="mailto:sales@stoeber.ch">sales@stoeber.ch</a>	<b>STOBER TAIWAN</b> <a href="http://www.stoeber.tw">www.stoeber.tw</a> Phone +886 2 2216-3428 <a href="mailto:sales@stoeber.tw">sales@stoeber.tw</a>
<b>STOBER TURKEY</b> <a href="http://www.stober.com">www.stober.com</a> Phone +90 216 510 2290 <a href="mailto:sales-turkey@stober.com">sales-turkey@stober.com</a>	<b>STOBER UK</b> <a href="http://www.stober.co.uk">www.stober.co.uk</a> Phone +44 1543 458 858 <a href="mailto:sales@stober.co.uk">sales@stober.co.uk</a>
<b>STOBER USA</b> <a href="http://www.stober.com">www.stober.com</a> Phone +1 606 759 5090 <a href="mailto:sales@stober.com">sales@stober.com</a>	

# Glossary

## 100Base-TX

---

Ethernet network standard based on symmetrical copper cables in which the nodes are connected to a switch via copper cables twisted in pairs (shielded twisted pair, CAT 5e quality level). 100Base-TX is the subsequent progression from 10Base-T and includes those properties with the option of a transfer speed of 100 Mbps (Fast Ethernet).

## Band

---

In the context of a scope, a section in the display of a scope image. The recorded channels can be individually assigned, each to one such section.

## Braking resistor

---

Electrical resistor that is switched on by a brake chopper in order to avoid a hazard to electrical components in the event of significant brake energy by limiting the DC link voltage. Braking energy, which is usually only present for brief periods, is converted into heat in the resistor.

## Broadcast domain

---

Logical grouping of network devices within a local network that reaches all nodes via broadcast.

## Channel (scope, multi-axis scope)

---

The reserved disk space for recording a signal in DriveControlSuite. As part of a scope image, up to 12 channels can be recorded simultaneously.

## Channel assignment

---

Source of the data that is recorded with/by/in a channel. For example, this may involve parameters that are transmitted in a cyclical fieldbus communication channel or a parameter that is recorded in a measurement channel.

## Circuit breakers

---

Current-limiting switches for motor or starter protection. They guarantee safe shut-off in the event of a short circuit and protect loads and systems from overload.

## Control cascade

---

Complete model of the control structure with the position controller, velocity controller and current controller components.

## Current controller

---

Controller that is part of the control cascade and makes sure the deviation between the set and actual torque/force is small. In addition, it uses the deviation to calculate a value for the set current and transfers this to the power unit. The controller has a part that controls torque/force and a part that controls the magnetic flux.

## Cyclic redundancy check (CRC)

---

Procedure for determining a check value for data in order to detect errors during transmission or saving.

---

### DC link discharge time

---

Time until the DC link capacitors are discharged enough that the device can be worked on safely.

---

### Defense in depth

---

In accordance with DIN EN IEC 62443-4-1, an approach to defend the system against any kind of attack using multiple independent methods.

---

### Demilitarized zone (DMZ)

---

Specially controlled network located between the external network (Internet) and internal network. It represents a kind of buffer zone that separates the networks from each other through strict communication rules and firewalls.

---

### Differential (HTL/TTL)

---

In the context of signal transmission, a process for being able to transmit signals with the highest possible fault tolerance even with longer transmission paths. In this approach, transmission takes place using a pair of signal conductors instead of just one signal conductor. The actual signal is transmitted on one line and the inverse signal on the other.

---

### Discrete Fourier transform (DFT)

---

Maps a time-discrete signal onto a periodic, discrete frequency spectrum. A Fourier transform can be carried out on a scope image in DriveControlSuite. The spectrum display of the scope image shows all occurring frequencies. The amplitude of a frequency stands for its frequency of occurrence.

---

### Electronic nameplate

---

STOBER synchronous servo motors are generally equipped with absolute encoders that provide special memory. This memory includes the electronic nameplate, i.e. all type-relevant master data as well as special mechanical and electronic values of a motor. When you operate a drive controller with a STOBER synchronous servo motor and an absolute encoder, the electronic nameplate is read and all motor data transferred if the drive controller is connected online. The drive controller automatically determines the associated limit values and control parameters from this data.

---

### Emergency stop

---

An energy supply to the machine drives that could cause a dangerous situation must either be immediately interrupted (stop category 0) or controlled so that the dangerous movement is stopped as quickly as possible (stop category 1) without creating other risks.

---

### Firewall

---

Network security device that monitors incoming and outgoing network traffic and decides whether to allow or block specific traffic based on a set of defined security rules. It is based either on hardware, software or a combination of both.

---

### Frequency analysis

---

Method for investigating how frequently certain events occur in a certain time span, or how strongly which frequency components are represented in a signal.

---

### IPv4 limited broadcast

---

Type of broadcast in a network with IPv4 (Internet Protocol version 4). The IP address 255.255.255.255 is entered as the destination. The content of the broadcast is not forwarded by a router, which limits it to the local network.

---

### I-share

---

Integral share of the controller that acts on the manipulated variable through the temporal integration of the control deviation with the weighting caused by the reset time: the longer the control difference is present, the stronger the response is.

---

### KTY temperature sensor

---

Temperature sensor with a resistance characteristic that follows the temperature in a nearly linear fashion. As a result, it allows for analog measurements of the motor temperatures. However, measurements are each limited to one phase of the motor winding, which is why motor protection is significantly limited compared to PTC triplets.

---

### Life performance indicator

---

Value for the calculated life performance of the geared motor.

---

### Load matrix

---

Recording of the frequency distribution of speeds and torques that occurred at the output of the geared motor.

---

### Miniature circuit breakers

---

Special switch that protects electrical systems from overload and short circuits. It is specifically used for the fuse protection of individual cores or cables. The switch has different triggering characteristics (A, B, C, D) and, thus, serves all application areas in industrial, functional and residential construction.

---

### Multi-axis scope

---

Analysis tool of DriveControlSuite with graphical output. It can be used to create synchronized scope images of multiple drive controllers or axes in order to measure and depict the progress of parameter values, signal names or physical addresses over time.

---

### MV number

---

The number of the material variant ordered and delivered as stored in the enterprise resource planning system, i.e. the device-specific combination of all hardware and software components.

---

### Output choke

---

This type of choke is used to reduce high-frequency currents on electric lines and thus increase the interference immunity and availability of drive systems. They reduce current peaks caused by line capacity at the power output of the drive controller. It makes long power cables possible and increases the motor service life.

---

### P controller

---

Controller type in which the manipulated variable is always proportional to the recorded control difference. As a result of this, the controller responds to the control deviation without a delay and only creates a manipulated variable if a deviation is present. It is a fast and stable controller with a permanent control deviation that can be used for non-critical controls where permanent control deviation can be accepted when faults occur, e.g. pressure, flow, fill level and temperature control.

---

### Performance Level (PL)

---

In accordance with DIN EN ISO 13849-1: Measure for the reliability of a safety function or a component. The Performance Level is measured on a scale of a – e (lowest – highest PL). The higher the PL, the safer and more reliable the function in question is. The PL can be assigned to a specific SIL. A reversed inference from a SIL to a PL is not possible.

---

### PI controller

---

Controller type that results from a parallel connection of a P and an I controller. With the right layout, it combines the advantages of both types (stable and fast, no permanent control deviation) and compensates for the disadvantages simultaneously.

---

### PID controller

---

Universal controller type with a P-, I- and D-share. These three adjustment parameters make the controller flexible and ensure exact and highly dynamic control. However, by implication, it also necessitates a wide variety of variants. It is that much more important to ensure careful construction that is well-coordinated to the system. The application areas for this controller type are control circuits with systems of the second order and higher, which must be stabilized quickly and do not allow for any permanent control deviation.

---

### Plausibility encoder

---

Encoder used for checking other encoders in the context of safety technology but which cannot be used for velocity or position control.

---

### Plug connectors

---

Component for disconnecting and connecting cables. The connecting parts are appropriately aligned by the positive locking of the plug pieces, feature detachable, positive attachment by spring force (pin) and are often also secured against unintended disconnection by a screw connection.

---

### Position controller

---

Controller that is part of the control cascade and makes sure the deviation between the set and actual position is small. To do so, it calculates a set velocity from the deviation and passes it to the velocity controller.

---

### Power choke

---

Choke type that delays the current increase at the input of the drive controller or supply module in order to reduce the harmonics in the supply grid and reduces the load of the power feed-in of the devices.

---

### Predictive Maintenance (PRM)

---

Proactive maintenance process based on permanent monitoring and evaluation of machine and process data. The aim here is to predict future maintenance requirements, thereby avoiding faults and making maintenance processes more efficient.

---

### Pre-trigger

---

Percentage portion of the recording time that takes place before the trigger and that defines the starting time of the scope image.

---

### Pre-trigger time

---

Portion of the recording time that takes place before the trigger and that defines the starting time of the scope image.

---

### PROFINET

---

Open Ethernet standard of PROFIBUS Nutzerorganisation e. V. (PNO) for automation.

---

### PROFINET RT

---

Transmission method for time-critical process data in a PROFINET IO system.

---

### P-share

---

Proportional share of the controller gain: the greater this share is, the stronger the influence on the manipulated variable.

---

### Pt1000 temperature sensor

---

Temperature sensor made of platinum with a resistance characteristic that follows the temperature in a linear fashion. As a result, it allows for analog measurements of the motor temperatures. However, measurements are each limited to one phase of the motor winding, which is why motor protection is significantly limited compared to PTC triplets.

---

### PTC thermistor

---

Thermistor whose resistance significantly changes with the temperature. When a PTC reaches its defined nominal response temperature, the resistance increases dramatically, by two or more times the original resistance, to several kOhms. Since PTC triplets are used, each thermistor monitors one phase of the motor winding. For 3 thermistors, this means all 3 phases are monitored, achieving effective motor protection.

---

### Quantization

---

Conversion of analog signals into numbers and measurable variables. For this purpose, the analog signals are scanned in regular intervals at the sampling rate and their voltage rating is converted at each of these scanning points to a digital value. The analog signal can only be expressed in a finite number of digital values.

---

### Recording time

---

Recording of an image, occurrence, acoustic event or other event on a corresponding medium. In the context of a scope, the display of the calculated duration of scope image recording. The memory size, sampling time and channels used form the basis of the calculation.



---

## Reforming

---

Protective measure for drive controllers. In case of a longer storage time, the oxide layer of the capacitors reacts with the electrolytes. This influences the electrical strength and capacitance. The process, which is to be performed before commissioning, re-establishes the dielectric in the capacitors.

---

## Reverse documentation

---

Refers to a read-only file read out by a drive controller that includes the fault memory in addition to the configuration of a drive controller. This file is a snapshot of the time that the connection between the PC and drive controller was interrupted. The information it contains is used for diagnostics as well as for processing service requests.

---

## Safe Brake Control (SBC)

---

In accordance with DIN EN 61800-5-2: A safety function that provides safe output signals for controlling external brakes.

---

## Safe Brake Test (SBT)

---

Safety function that tests the proper functioning of a quiescent current actuated brake.

---

## Safe Direction (SDI)

---

In accordance with DIN EN 61800-5-2: A safety function that prevents the motor shaft from moving in the unintended direction.

---

## Safe Stop 1 (SS1)

---

In accordance with DIN EN 61800-5-2: Procedure for stopping a PDS(SR). With the SS1 safety function, the PDS(SR) performs one of the following functions: a) Triggering and controlling the motor delay variable within defined limits and triggering the STO function if the motor speed falls below a specified limit value (SS1-d), or b) triggering and monitoring the motor delay variable within defined limits and triggering the STO function if the motor speed falls below a specified limit value (SS1-r), or c) triggering the motor delay and triggering the STO function after an application-specific delay (SS1-t). In this case, SS1(-t) corresponds to the time-controlled stop in accordance with IEC 60204-1, stop category 1(-t).

---

## Safe Stop 2 (SS2)

---

In accordance with DIN EN 61800-5-2: Procedure for stopping a PDS(SR). For the safety function SS2, the PDS(SR) performs one of the following functions: a) Initiation and control of the size of the motor delay within defined limits and triggering the SOS function when the motor speed drops below a defined limit value, or b) Initiation and monitoring of the size of the motor delay within defined limits and initiation of the SOS function when the motor speed drops below a limit value, or c) initiation of the motor delay and initiation of the SOS function after an application-specific time delay. This safety function corresponds to a controlled stop according to IEC 60204-1, stop category 2.

---

## Safe Torque Off (STO)

---

In accordance with DIN EN 61800-5-2: Procedure for stopping a PDS(SR). The STO safety function prevents the motor from being supplied with any energy that could cause rotation (or motion in a linear motor). The PDS(SR) does not supply the motor with any energy that could generate torque (or force in a linear motor). STO is the most fundamental drive-integrated safety function. It corresponds to an uncontrolled stop in accordance with DIN EN 60204-1, stop category 0.

---

### Safely-Limited Increment (SLI)

---

In accordance with DIN EN 61800-5-2: A safety function that prevents the motor shaft from exceeding a position increment limit.

---

### Safely-Limited Speed (SLS)

---

In accordance with DIN EN 61800-5-2: A safety function that prevents the motor from exceeding the defined velocity limit.

---

### Safety Integrity Level (SIL)

---

In accordance with DIN EN 61800-5-2: Probability of a safety function failure. SIL is divided into levels 1 – 4 (lowest – highest level). SIL precisely assesses systems or subsystems based on the reliability of their safety functions. The higher the SIL, the safer and more reliable the function in question is.

---

### Sampling time

---

In signal processing, the time after which an analog signal (also called a continuous-time signal) is scanned again, i.e. measured and converted into a discrete-time signal.

---

### Scope

---

Analysis tool of DriveControlSuite with graphical output. It can be used to create scope images of a drive controller in order to measure and depict the progress of parameter values, signal names or physical addresses over time. The term stems from traditional scope-type measuring instruments.

---

### Scope memory

---

Disk space in the drive controller that records the data of a scope image.

---

### Security

---

Term for the protection and safety of components and systems with regard to confidentiality, integrity and availability.

---

### Self-discharge

---

Passive running process that causes the capacitors to discharge even when no electrical load is connected.

---

### Serial number

---

Consecutive number stored for a product in the enterprise resource planning system and used for individual identification of the product and for determining the associated customer information.

---

### Single-ended (HTL/TTL)

---

In the context of signal transmission, electrical signal transmission takes place using a voltage that changes in relation to a constant reference potential.

---

### System parameter

---

Parameter that is defined by the firmware. Examples include parameters for motor control, for encoders or parameters of the control cascade.

### Template

---

In the context of the DriveControlSuite commissioning software, a template for graphical programming. This template can be selected in the configuration dialog for device control, communication (fieldbus) or application in a certain version.

### Trigger

---

Switch or software function that generates a pulse or a switching operation during a triggering event.

### Trigger condition

---

Triggering event that generates a pulse or switching operation.

### Velocity controller

---

Controller that is part of the control cascade and makes sure the deviation between the set and actual velocity is small. In addition, it uses the deviation to calculate a value for the set torque/force and transfers this to the current controller.

### Window function

---

Auxiliary function for minimizing the leakage effect for the Fourier transform.

# List of figures

Fig. 1	Defense in depth concept .....	23
Fig. 2	System overview .....	26
Fig. 3	SD6A06TEX nameplate.....	27
Fig. 4	Sticker with MV and serial number .....	29
Fig. 5	SD6 dimensional drawing, sizes 0 to 2 .....	54
Fig. 6	SD6 dimensional drawing, size 3 .....	55
Fig. 7	DL6A dimensional drawing.....	58
Fig. 8	FZMU (1), FZZMU (2) dimensional drawing.....	82
Fig. 9	GVADU, GBADU dimensional drawing .....	84
Fig. 10	FGFKU dimensional drawing .....	86
Fig. 11	Power choke dimensional drawing .....	89
Fig. 12	TEP dimensional drawing .....	91
Fig. 13	LA6 dimensional drawing [mm] .....	92
Fig. 14	Grounding concept in mixed operation with SI6 and SC6 with powered SD6 drive controller.....	98
Fig. 15	Grounding concept in mixed operation with SI6 with powered SD6 drive controller .....	99
Fig. 16	Derating the nominal current based on surrounding temperature .....	100
Fig. 17	Derating the nominal current depending on installation elevation .....	100
Fig. 18	Derating the voltage depending on installation elevation .....	100
Fig. 19	Derating the nominal current depending on the clock frequency, TEP3720-0ES41 .....	101
Fig. 20	Derating the nominal current depending on the clock frequency, TEP3820-0CS41 .....	101
Fig. 21	Derating the nominal current depending on the clock frequency, TEP4020-ORS41 .....	102
Fig. 22	Derating the nominal current based on surrounding temperature .....	103
Fig. 23	Derating the nominal current depending on installation elevation .....	103
Fig. 24	Derating the voltage depending on installation elevation .....	103
Fig. 25	Voltage levels dependent on storage time .....	105
Fig. 26	Minimum clearances .....	108
Fig. 27	SD6 and DL6A drilling diagram .....	110
Fig. 28	FZMU, FZZMU drilling diagram.....	112
Fig. 29	GVADU, GBADU drilling diagram.....	112
Fig. 30	FGFKU drilling diagram.....	113
Fig. 31	Power choke drilling diagram.....	113
Fig. 32	TEP drilling diagram.....	114
Fig. 33	Connection of the grounding conductor .....	143
Fig. 34	Connection overview of sizes 0 and 1 with ST6 safety module.....	145
Fig. 35	Connection overview of size 2 with ST6 safety module.....	146

Fig. 36	Connection overview of size 3 with ST6 safety module, top of device .....	147
Fig. 37	Connection overview of size 3 with ST6 safety module, bottom of device.....	148
Fig. 38	Connection overview of sizes 0 and 1 with SE6 safety module.....	150
Fig. 39	Connection overview of size 2 with SE6 safety module .....	151
Fig. 40	Connection overview of size 3 with SE6 safety module, top of device .....	152
Fig. 41	Connection overview of size 3 with SE6 safety module, bottom of device.....	154
Fig. 42	FZMU connection overview .....	176
Fig. 43	FZZMU connection overview.....	176
Fig. 44	FGFKU connection overview .....	178
Fig. 45	FGFKU connection overview .....	178
Fig. 46	TEP output choke connection example.....	180
Fig. 47	Shielded connection of the power cable.....	181
Fig. 48	Connection overview for EC6 communication module.....	181
Fig. 49	Connection overview for CA6 communication module .....	183
Fig. 50	Connection overview for PN6 communication module .....	184
Fig. 51	Connection overview for the XI6 terminal module .....	186
Fig. 52	Connection overview for the RI6 terminal module.....	193
Fig. 53	Connection overview for the IO6 terminal module .....	203
Fig. 54	Connection overview for the LA6 adapter box .....	208
Fig. 55	Operating unit of the SD6 drive controller.....	234
Fig. 56	Menu structure and navigation using the SD6 operating unit .....	235
Fig. 57	DS6: Program interface .....	237
Fig. 58	Schematic test sequence for wiring and function test.....	255
Fig. 59	Structure of the control cascade .....	259
Fig. 60	Schematic sequence of optimization based on relevant parameters .....	263
Fig. 61	Velocity controller – Filters for the actual velocity .....	264
Fig. 62	Velocity controller – Proportional coefficient .....	266
Fig. 63	Scope – Proportional coefficient of the velocity controller (C31), default value .....	267
Fig. 64	Scope – Proportional coefficient of the velocity controller (C31), continuous oscillations .....	267
Fig. 65	Scope – Proportional coefficient of the velocity controller (C31), optimized value .....	268
Fig. 66	Scope – Proportional coefficient of the velocity controller (C31), overshooting.....	269
Fig. 67	Velocity controller – Integral coefficient.....	270
Fig. 68	Scope – Integral coefficient of the velocity controller (C32).....	271
Fig. 69	Position controller – Proportional coefficient.....	272
Fig. 70	Position controller – Feedforward control of the velocity controller .....	273
Fig. 71	Scope – Motor reaches saturation without tracking (B59) .....	274

Fig. 72	Scope – Motor reaches saturation with tracking (B59).....	275
Fig. 73	Brake control for control mode B20 = 0: ASM - V/f-control or 1: ASM - V/f-slip compensated .....	286
Fig. 74	Brake control for control mode B20 = 2: ASM - vector control.....	287
Fig. 75	Brake control for control mode B20 = 3: ASM - sensorless vector control .....	288
Fig. 76	Brake control for control mode B20 = 48: SSM-vector control incremental encoder, 64: SSM - vector control or 70: SLM - vector control .....	289
Fig. 77	Minimum time between two release processes for the brake .....	291
Fig. 78	State machine of brake management .....	294
Fig. 79	Scaling of the recorded speed classes.....	308
Fig. 80	Scaling of the recorded torque classes.....	308
Fig. 81	Signaling area .....	312
Fig. 82	Predictive Maintenance: Options for readout .....	313
Fig. 83	Positions of the diagnostic LEDs on the front and top of the drive controller .....	315
Fig. 84	LEDs for the state of the drive controller on the front of the SD6.....	316
Fig. 85	Appearance of a fault on the display .....	317
Fig. 86	LEDs for the state of the service network connection on the top of the SD6.....	320
Fig. 87	LEDs for the EtherCAT state .....	321
Fig. 88	LEDs for the PROFINET state .....	322
Fig. 89	LEDs for the CAN status .....	323
Fig. 90	LEDs for the IGB state on the top of the device .....	324
Fig. 91	LEDs for the state of the EtherCAT network connection .....	325
Fig. 92	LEDs for the state of the PROFINET network connection .....	326
Fig. 93	Scope and multi-axis scope: Program interface.....	388
Fig. 94	Scope and multi-axis scope: Image editor.....	396
Fig. 95	Multi-axis scope: network structure .....	407
Fig. 96	Wiring example of stand-alone operation with direct brake control.....	436
Fig. 97	Wiring example of stand-alone operation with indirect brake control.....	437
Fig. 98	Wiring example with Quick DC-Link .....	438
Fig. 99	IGB and IGB motion bus network.....	443
Fig. 100	Script mode: Program interface .....	446
Fig. 101	Test setup of the application examples .....	465

## List of tables

Tab. 1	File number-certified products .....	13
Tab. 2	Maximum differential short-circuit current .....	20
Tab. 3	Maximum differential short-circuit current .....	24
Tab. 4	Meaning of the specifications on the nameplate.....	28
Tab. 5	Example code for type designation .....	29
Tab. 6	Meaning of the example code.....	29
Tab. 7	Meaning of the specifications on the sticker .....	29
Tab. 8	Available SD6 types and sizes.....	30
Tab. 9	Device features.....	43
Tab. 10	Transport and storage conditions .....	43
Tab. 11	Operating conditions.....	43
Tab. 12	Discharge times of the DC link circuit.....	43
Tab. 13	Control unit electrical data.....	44
Tab. 14	SD6 electrical data, size 0.....	44
Tab. 15	SD6 electrical data, size 0, for 4 kHz clock frequency .....	44
Tab. 16	SD6 electrical data, size 0, for 8 kHz clock frequency .....	45
Tab. 17	Brake chopper electrical data, size 0.....	45
Tab. 18	SD6 electrical data, size 1.....	45
Tab. 19	SD6 electrical data, size 1, for 4 kHz clock frequency .....	45
Tab. 20	SD6 electrical data, size 1, for 8 kHz clock frequency .....	45
Tab. 21	Brake chopper electrical data, size 1.....	46
Tab. 22	SD6 electrical data, size 2.....	46
Tab. 23	SD6 electrical data, size 2, for 4 kHz clock frequency .....	46
Tab. 24	SD6 electrical data, size 2, for 8 kHz clock frequency .....	46
Tab. 25	Brake chopper electrical data, size 2.....	46
Tab. 26	SD6 electrical data, size 3.....	47
Tab. 27	SD6 electrical data, size 3, for 4 kHz clock frequency .....	47
Tab. 28	SD6 electrical data, size 3, for 8 kHz clock frequency .....	47
Tab. 29	Brake chopper electrical data, size 3.....	47
Tab. 30	X1 electrical data.....	48
Tab. 31	Power loss data of the SD6 drive controller in accordance with EN 61800-9-2.....	49
Tab. 32	Absolute losses of the accessories .....	51
Tab. 33	Nominal output current I <sub>2N</sub> , PU dependent on the clock frequency .....	52
Tab. 34	SD6 dimensions, sizes 0 to 2 [mm].....	54
Tab. 35	SD6 dimensions, size 3 [mm].....	55

Tab. 36	SD6 weight [g] .....	56
Tab. 37	Weight of the accessory part [g] .....	56
Tab. 38	Cycle times .....	56
Tab. 39	Device features.....	56
Tab. 40	Transport and storage conditions .....	57
Tab. 41	Operating conditions.....	57
Tab. 42	Assignment of DL6A to SD6.....	57
Tab. 43	DL6A dimensions [mm] .....	58
Tab. 44	DL6A weight [g] .....	59
Tab. 45	X12 electrical data.....	59
Tab. 46	X14 electrical data – Digital inputs (SE6 option) .....	60
Tab. 47	X15 electrical data – Digital outputs (SE6 option).....	60
Tab. 48	Motor types and control modes .....	61
Tab. 49	Encoder connections .....	62
Tab. 50	Signal level of encoder outputs, single-ended .....	63
Tab. 51	Signal levels of encoder outputs, differential.....	63
Tab. 52	EnDat 2.1 digital specification .....	64
Tab. 53	EnDat 2.2 digital specification .....	64
Tab. 54	SSI specification (free setting).....	64
Tab. 55	SSI specification.....	65
Tab. 56	Specification for incremental signals .....	65
Tab. 57	Encoder supply X4 .....	66
Tab. 58	SSI specification.....	66
Tab. 59	Specification for incremental signals .....	66
Tab. 60	Cable length [m] .....	67
Tab. 61	Specification for X101 on RI6 terminal module for incremental, pulse/direction or hall sensor signals .....	67
Tab. 62	Specification for X101 on XI6 terminal module for incremental, pulse/direction or hall sensor signals .....	68
Tab. 63	Specification for X101 on IO6 terminal module for incremental, pulse/direction or hall sensor signals.....	68
Tab. 64	SSI specification (free setting, evaluation and simulation) .....	69
Tab. 65	SSI specification (evaluation and simulation).....	69
Tab. 66	Specification for differential TTL incremental, pulse/direction or hall sensor signals .....	70
Tab. 67	X120 encoder supply .....	70
Tab. 68	EnDat 2.1 digital specification .....	70
Tab. 69	EnDat 2.2 digital specification .....	71
Tab. 70	Specification for resolver signals.....	71
Tab. 71	EnDat 2.1 sin/cos, sin/cos specification .....	71



Tab. 72	Encoder supply X140 .....	72
Tab. 73	Specification for TTL differential incremental signals .....	73
Tab. 74	Differential TTL Hall sensor signals specification .....	73
Tab. 75	Single-ended HTL Hall sensor signals specification .....	74
Tab. 76	Electrical data.....	74
Tab. 77	Cable length [m].....	74
Tab. 78	Differential TTL incremental signals with single-ended TTL Hall sensor signals specification.....	74
Tab. 79	General specification.....	75
Tab. 80	X100 electrical data for analog signals .....	75
Tab. 81	X101 electrical data for digital signals.....	75
Tab. 82	X102 electrical data .....	76
Tab. 83	X103A electrical data.....	76
Tab. 84	X103B electrical data.....	76
Tab. 85	X103C electrical data.....	76
Tab. 86	General specification.....	77
Tab. 87	X100 electrical data for analog signals .....	77
Tab. 88	X101 electrical data for digital signals.....	77
Tab. 89	General specification.....	78
Tab. 90	X100 electrical data for analog signals .....	78
Tab. 91	X101 electrical data for digital signals.....	79
Tab. 92	Weight of the accessory part [g] .....	79
Tab. 93	Electrical data of the brake output .....	80
Tab. 94	Electrical data of the brake output .....	80
Tab. 95	Triggering limit of temperature sensor .....	80
Tab. 96	Assignment of FZMU, FZZMU braking resistor – SD6 drive controller .....	81
Tab. 97	FZMU, FZZMU specification .....	82
Tab. 98	FZMU, FZZMU dimensions [mm].....	82
Tab. 99	Assignment of GVADU, GBADU braking resistor – SD6 drive controller .....	83
Tab. 100	GVADU, GBADU specification.....	83
Tab. 101	GVADU, GBADU dimensions [mm].....	84
Tab. 102	Assignment of FGFKU braking resistor – SD6 drive controller .....	85
Tab. 103	FGFKU specification.....	85
Tab. 104	FGFKU dimensions [mm].....	86
Tab. 105	Assignment of RB 5000 braking resistor – SD6 drive controller.....	86
Tab. 106	RB 5000 specification .....	87
Tab. 107	RB 5000 dimensions [mm] .....	87

Tab. 108	TEP specification .....	88
Tab. 109	TEP dimensions and weight.....	89
Tab. 110	TEP specification .....	90
Tab. 111	TEP dimensions and weight.....	91
Tab. 112	LA6 dimensions [mm].....	92
Tab. 113	LA6 weight [g].....	92
Tab. 114	Minimum clearances [mm] .....	108
Tab. 115	Dimensions [mm] .....	109
Tab. 116	Drilling dimensions for SD6 drive controller [mm].....	111
Tab. 117	Drilling dimensions for DL6A Quick DC-Link or rear section braking resistor [mm].....	111
Tab. 118	FZMU, FZZMU dimensions [mm].....	112
Tab. 119	GVADU, GBADU dimensions [mm].....	112
Tab. 120	FGFKU dimensions [mm].....	113
Tab. 121	TEP dimensions .....	114
Tab. 122	Determination of the correct length of the copper rails [mm] .....	115
Tab. 123	Maximum differential short-circuit current .....	137
Tab. 124	Line fuses in stand-alone operation .....	137
Tab. 125	Line fuses for DC link connection .....	138
Tab. 126	UL-compliant line fuses.....	140
Tab. 127	Individual components of Type E motor starters.....	140
Tab. 128	Minimum cross-section of the grounding conductor.....	142
Tab. 129	X1 connection description.....	155
Tab. 130	Cable length [m].....	155
Tab. 131	X2 connection description.....	156
Tab. 132	Cable length [m].....	156
Tab. 133	X3A and X3B connection description .....	157
Tab. 134	X4 connection description for EnDat 2.1/2.2 digital encoders .....	158
Tab. 135	X4 connection description for differential HTL incremental encoders .....	159
Tab. 136	X4 connection description for differential TTL incremental encoders.....	159
Tab. 137	Cable length [m].....	160
Tab. 138	X5 connection description.....	160
Tab. 139	Cable length [m].....	160
Tab. 140	Electrical data for the brake supply.....	161
Tab. 141	X6 connection description.....	161
Tab. 142	Cable length [m].....	161
Tab. 143	Electrical data for the brake supply.....	161

Tab. 144	X7 connection description.....	162
Tab. 145	Cable length [m].....	162
Tab. 146	X8 connection description.....	162
Tab. 147	Cable length [m].....	162
Tab. 148	X10 connection description – Size 0, 1-phase line connection .....	163
Tab. 149	X10 connection description – Size 0, 3-phase line connection .....	163
Tab. 150	X10 connection description – Size 1, 3-phase line connection .....	163
Tab. 151	X10 connection description – Size 2, 3-phase line connection .....	163
Tab. 152	X10 connection description – Size 3, 3-phase line connection .....	164
Tab. 153	Control unit electrical data.....	164
Tab. 154	X11 connection description.....	164
Tab. 155	Cable length [m].....	165
Tab. 156	X12 connection description.....	165
Tab. 157	Cable length [m].....	165
Tab. 158	X14 connection description.....	166
Tab. 159	Cable length [m].....	166
Tab. 160	X15 connection description.....	167
Tab. 161	Cable length [m].....	167
Tab. 162	X20 connection description – Size 0.....	168
Tab. 163	X20 connection description – Size 1.....	168
Tab. 164	X20 connection description – Size 2.....	168
Tab. 165	X20 connection description – Size 3.....	169
Tab. 166	Maximum cable length of the power cable [m].....	169
Tab. 167	X30 connection description – Size 0.....	170
Tab. 168	X30 connection description – Size 1.....	170
Tab. 169	X30 connection description – Size 2.....	170
Tab. 170	X50 connection description for SSI encoders.....	171
Tab. 171	X50 connection description for differential TTL incremental encoders.....	171
Tab. 172	X50 connector description for differential TTL incremental encoders.....	172
Tab. 173	Connection description of FZMU, FZZMU to sizes 0 to 2 .....	176
Tab. 174	Connection description of FZMU, FZZMU to size 3 .....	177
Tab. 175	Connection description of GVADU, GBADU to sizes 0 to 2 .....	177
Tab. 176	Connection description of GBADU to size 3 .....	177
Tab. 177	Connection description of FGFKU to sizes 0 to 2 .....	178
Tab. 178	Connection description of FGFKU to size 3 .....	178
Tab. 179	Connection description of RB 5000 to sizes 0 to 2 .....	179

Tab. 180	TEP power choke connection description .....	179
Tab. 181	TEP output choke connection description .....	180
Tab. 182	X200 and X201 connection description .....	182
Tab. 183	X200 connection description .....	183
Tab. 184	X200 and X201 connection description .....	185
Tab. 185	X100 connection description .....	187
Tab. 186	Cable length [m] .....	187
Tab. 187	X101 connection description for digital signals .....	187
Tab. 188	X101 connection description for single-ended HTL incremental signals .....	188
Tab. 189	X101 connection description for single-ended HTL pulse/direction signals .....	188
Tab. 190	X101 connection description for single-ended HTL Hall sensor signals .....	189
Tab. 191	Cable length [m] .....	189
Tab. 192	X102 connection description .....	189
Tab. 193	Cable length [m] .....	189
Tab. 194	X103A connection description .....	190
Tab. 195	Cable length [m] .....	190
Tab. 196	X103B connection description .....	190
Tab. 197	Cable length [m] .....	190
Tab. 198	X103C connection description .....	191
Tab. 199	Cable length [m] .....	191
Tab. 200	X120 connection description for SSI encoders .....	191
Tab. 201	X120 connection description for differential TTL incremental encoder .....	192
Tab. 202	X120 connection description for differential TTL Hall sensors .....	192
Tab. 203	X120 connection description for differential TTL pulse/direction signals .....	192
Tab. 204	Cable length [m] .....	193
Tab. 205	X100 connection description .....	193
Tab. 206	Cable length [m] .....	194
Tab. 207	X101 connection description for digital signals .....	194
Tab. 208	X101 connection description for single-ended HTL and single-ended TTL incremental signals .....	195
Tab. 209	X101 connection description for single-ended HTL and single-ended TTL pulse/direction signals .....	195
Tab. 210	X101 connection description for single-ended HTL Hall sensor signals .....	196
Tab. 211	Cable length [m] .....	196
Tab. 212	X120 connection description for SSI encoders .....	196
Tab. 213	X120 connection description for differential TTL incremental encoder .....	197
Tab. 214	X120 connection description for differential TTL Hall sensors .....	197
Tab. 215	X120 connection description for differential TTL pulse/direction signals .....	197

Tab. 216	Cable length [m] .....	198
Tab. 217	X140 connection description for EnDat 2.1/2.2 digital encoders.....	198
Tab. 218	X140 connection description for resolvers.....	199
Tab. 219	X140 connection description for EnDat 2.1 sin/cos encoders.....	199
Tab. 220	X140 connection description for sin/cos encoders .....	200
Tab. 221	Cable length [m] .....	200
Tab. 222	AP6A00 connection description for resolver (9-pin to 15-pin) .....	200
Tab. 223	AP6A01 connection description for the resolver and motor temperature sensor (9-pin to 15-pin) .....	201
Tab. 224	AP6A02 connection description for EnDat 2.1 sin/cos encoder and motor temperature sensor (15-pin to 15-pin) .....	202
Tab. 225	X100 connection description.....	203
Tab. 226	Cable length [m] .....	203
Tab. 227	X101 connection description for digital signals.....	204
Tab. 228	X101 connection description for single-ended HTL incremental signals.....	205
Tab. 229	X101 connection description for single-ended HTL pulse/direction signals .....	205
Tab. 230	X101 connection description for single-ended HTL Hall sensor signals .....	206
Tab. 231	Cable length [m] .....	206
Tab. 232	X300 connection description for differential TTL incremental encoders .....	209
Tab. 233	Cable length [m] .....	209
Tab. 234	X301 connection description for differential TTL hall sensors .....	210
Tab. 235	Cable length [m] .....	210
Tab. 236	X302 connection description for single-ended TTL hall sensors .....	211
Tab. 237	Cable length [m] .....	211
Tab. 238	Electrical data.....	211
Tab. 239	X303 connection description.....	211
Tab. 240	Cable length [m] .....	212
Tab. 241	X304 connection description for differential TTL incremental encoder with single-ended TTL Hall sensor ...	212
Tab. 242	Cable length [m] .....	212
Tab. 243	X305 connection description for differential incremental encoder with single-ended TTL Hall sensor .....	213
Tab. 244	X306 connection description for differential TTL incremental encoder with single-ended TTL Hall sensor ...	213
Tab. 245	Cable length [m] .....	213
Tab. 246	Maximum cable length of the power cable [m] .....	216
Tab. 247	con.15 power cable pin assignment.....	217
Tab. 248	con.15 connector dimensions .....	217
Tab. 249	con.23 power cable pin assignment.....	217
Tab. 250	con.23 connector dimensions .....	217

Tab. 251	con.40 power cable pin assignment.....	218
Tab. 252	con.40 connector dimensions .....	218
Tab. 253	con.58 power cable pin assignment.....	218
Tab. 254	con.58 connector dimensions .....	218
Tab. 255	con.15 encoder cable pin assignment, EnDat 2.1/2.2 digital .....	220
Tab. 256	con.15 connector dimensions .....	220
Tab. 257	con.17 encoder cable pin assignment, EnDat 2.1/2.2 digital .....	221
Tab. 258	con.17 connector dimensions .....	221
Tab. 259	con.23 encoder cable pin assignment, EnDat 2.1/2.2 digital .....	222
Tab. 260	con.23 dimensions .....	222
Tab. 261	con.23 encoder cable pin assignment, SSI .....	223
Tab. 262	con.23 dimensions .....	223
Tab. 263	con.23 encoder cable pin assignment, incremental HTL.....	224
Tab. 264	con.23 dimensions .....	224
Tab. 265	con.17 encoder cable pin assignment.....	225
Tab. 266	con.17 connector dimensions .....	225
Tab. 267	con.15 encoder cable pin assignment, resolver .....	227
Tab. 268	con.15 connector dimensions .....	227
Tab. 269	con.17 encoder cable pin assignment, resolver .....	228
Tab. 270	con.17 connector dimensions .....	228
Tab. 271	con.23 encoder cable pin assignment, resolver .....	229
Tab. 272	con.23 dimensions .....	229
Tab. 273	con.15 encoder cable pin assignment, EnDat 2.1 sin/cos .....	231
Tab. 274	con.15 connector dimensions .....	231
Tab. 275	con.17 encoder cable pin assignment, EnDat 2.1 sin/cos .....	232
Tab. 276	con.17 connector dimensions .....	232
Tab. 277	con.23 encoder cable pin assignment, EnDat 2.1 sin/cos .....	233
Tab. 278	con.23 dimensions .....	233
Tab. 279	Parameter groups.....	239
Tab. 280	Parameters: data types, parameter types, possible values .....	240
Tab. 281	Parameter types.....	241
Tab. 282	Requirements for a direct connection .....	258
Tab. 283	Guide values for C34 .....	264
Tab. 284	Application cases for brake management.....	276
Tab. 285	Correlation between F06 and F92[0] .....	286
Tab. 286	Bearing design features.....	306

Tab. 287	Shaft design features.....	306
Tab. 288	Shaft/pinion position features .....	306
Tab. 289	Gear unit option features.....	306
Tab. 290	Information on the load matrix.....	309
Tab. 291	Load matrix: impermissible characters or control characters.....	310
Tab. 292	Predictive Maintenance files on SD card.....	314
Tab. 293	Meaning of file extensions on SD card .....	314
Tab. 294	Meaning of the blue LED (REMOTE).....	316
Tab. 295	Meaning of the green and red LED (RUN).....	316
Tab. 296	*NoConfiguration, Cause: ParaModul Error – Causes and actions .....	318
Tab. 297	*NoConfiguration, Cause: ConfigStartError – Causes and actions .....	318
Tab. 298	*NoConfiguration, Cause: Configuration Stopped – Causes and actions .....	319
Tab. 299	Meaning of the green LED (LINK) .....	320
Tab. 300	Meaning of the yellow LED (ACTIVITY).....	320
Tab. 301	Meaning of the green LED (Run) .....	321
Tab. 302	Meaning of the red LED (error) .....	321
Tab. 303	Meaning of the red LED (BF) .....	322
Tab. 304	Meaning of the green LED (Run) .....	322
Tab. 305	Meaning of the green LED (Run) .....	323
Tab. 306	Meaning of the red LED (error) .....	323
Tab. 307	Meaning of the green LED (RUN) .....	324
Tab. 308	Meaning of the red LED (ERROR) .....	324
Tab. 309	Meaning of the green LEDs (LA).....	325
Tab. 310	Meaning of the green LEDs (Link) .....	326
Tab. 311	Meaning of the yellow LEDs (Act.) .....	326
Tab. 312	Events.....	327
Tab. 313	Event 31 – Causes and actions .....	329
Tab. 314	Event 32 – Causes and actions .....	329
Tab. 315	Event 33 – Causes and actions .....	330
Tab. 316	Event 34 – Causes and actions .....	331
Tab. 317	Event 35 – Causes and actions .....	332
Tab. 318	Event 36 – Causes and actions .....	332
Tab. 319	Event 37 – Causes and actions .....	333
Tab. 320	Event 38 – Causes and actions .....	336
Tab. 321	Event 39 – Causes and actions .....	337
Tab. 322	Event 40 – Causes and actions .....	338

Tab. 323	Event 41 – Causes and actions .....	339
Tab. 324	Event 42 – Causes and actions .....	340
Tab. 325	Event 43 – Causes and actions .....	341
Tab. 326	Event 44 – Causes and actions .....	342
Tab. 327	Event 45 – Causes and actions .....	343
Tab. 328	Event 46 – Causes and actions .....	344
Tab. 329	Event 47 – Causes and actions .....	345
Tab. 330	Event 48 – Causes and actions .....	346
Tab. 331	Event 49 – Causes and actions .....	347
Tab. 332	Event 50 – Causes and actions .....	348
Tab. 333	Event 51 – Causes and actions .....	349
Tab. 334	Event 52 – Causes and actions .....	350
Tab. 335	Event 53 – Causes and actions .....	351
Tab. 336	Event 54 – Causes and actions .....	352
Tab. 337	Event 55 – Causes and actions .....	353
Tab. 338	Event 56 – Causes and actions .....	354
Tab. 339	Event 57 – Causes and actions .....	355
Tab. 340	Event 58 – Causes and actions .....	356
Tab. 341	Event 59 – Causes and actions .....	357
Tab. 342	Events 60 – 67 – Causes and actions .....	358
Tab. 343	Event 68 – Causes and actions .....	359
Tab. 344	Event 69 – Causes and actions .....	360
Tab. 345	Event 70 – Causes and actions .....	361
Tab. 346	Event 71 – Causes and actions .....	362
Tab. 347	Events 72 – 75 – Causes and actions .....	363
Tab. 348	Event 76 – Causes and actions .....	364
Tab. 349	Event 77 – Causes and actions .....	367
Tab. 350	Event 78 – Causes and actions .....	369
Tab. 351	Event 79 – Causes and actions .....	370
Tab. 352	Event 80 – Causes and actions .....	371
Tab. 353	Event 81 – Causes and actions .....	372
Tab. 354	Event 82 – Causes and actions .....	373
Tab. 355	Event 83 – Causes and actions .....	374
Tab. 356	Event 84 – Causes and actions .....	375
Tab. 357	Event 85 – Causes and actions .....	376
Tab. 358	Event 88 – Causes and actions .....	377



Tab. 359	Event 90 – Causes and actions .....	378
Tab. 360	Error list of the SE6 safety module.....	381
Tab. 361	Application cases for scope and multi-axis scope .....	387
Tab. 362	Weights of SD6 and accessories .....	424
Tab. 363	Terminal specifications for the base device .....	426
Tab. 364	Terminal specifications of the ST6 safety module.....	426
Tab. 365	Terminal specifications of the SE6 safety module.....	426
Tab. 366	Terminal specifications for the terminal modules .....	427
Tab. 367	Terminal specifications for the encoder adapter box .....	427
Tab. 368	Terminal specifications for the braking resistors .....	427
Tab. 369	BCF 3.81 180 SN BK specification .....	428
Tab. 370	BFL 5.08HC 180 SN specification .....	428
Tab. 371	BLDF 5.08 180 SN specification .....	429
Tab. 372	Specification for DFMC 1.5 -ST-3.5.....	429
Tab. 373	FK-MCP 1,5 -ST-3,5 specification.....	430
Tab. 374	FMC 1,5 -ST-3,5 specification .....	431
Tab. 375	G 10/2 specification .....	431
Tab. 376	GFKC 2,5 -ST-7,62 specification .....	432
Tab. 377	Specification for GFKIC 2.5 -ST-7.62 .....	432
Tab. 378	ISPC 5 -STGCL-7,62 specification .....	433
Tab. 379	SPC 16 -ST-10,16 specification .....	433
Tab. 380	MKDSP 25 -15,00 specification.....	434
Tab. 381	SPC 5 -ST-7,62 specification .....	434
Tab. 382	SPC 16 -ST-10,16 specification .....	435
Tab. 383	Programs and services.....	442
Tab. 384	Protocols and ports for a direct connection.....	442
Tab. 385	Protocols and ports for STOBER remote maintenance .....	442
Tab. 386	Script mode commands.....	449
Tab. 387	Script mode: Variables for importing and exporting parameters .....	458
Tab. 388	Script mode: Variables for importing and exporting parameters .....	459
Tab. 389	Script mode: Exit statuses .....	468
Tab. 390	Examples of rotational SSI encoders at X4 .....	471
Tab. 391	Examples of translational SSI encoders at X4.....	472
Tab. 392	Examples of rotational SSI encoders at X120 .....	474
Tab. 393	Examples of translational SSI encoders at X120.....	475



4 4 2 4 2 6 . 1 2

01/2023

STÖBER Antriebstechnik GmbH + Co. KG  
Kieselbronner Str. 12  
75177 Pforzheim  
Germany  
Tel. +49 7231 582-0  
mail@stoeber.de  
www.stober.com

24 h Service Hotline  
+49 7231 582-3000

[www.stober.com](http://www.stober.com)