



ROBO Cylinder RCP5 Actuator Belt Type

Instruction Manual

═══════════ **First Edition** ═══════════

BA4/BA4U
BA6/BA6U
BA7/BA7U

Please Read Before Use

Thank you for purchasing our product.

This instruction manual explains the handling methods, structure and maintenance of this product, among others, providing the information you need to know to use the product safely.

Before using the product, be sure to read this manual and fully understand the contents explained herein to ensure safe use of the product.

The DVD that comes with the product contains instruction manuals for IAI products.

When using the product, refer to the necessary portions of the applicable instruction manual by printing them out or displaying them on a PC.

After reading the instruction manual, keep it in a convenient place so that whoever is handling this product can reference it quickly when necessary.

[Important]

- This instruction manual is original.
- This product is not to be used for any other purpose from what is noted in this instruction manual. IAI shall not be liable whatsoever for any loss or damage arising from the result of using the product for any other purpose from what is noted in the manual.
- The information contained in this instruction manual is subject to change without notice for the purpose of production improvement.
- If you have any question or finding regarding the information contained in this instruction manual, contact our customer center or our sales office near you.
- Using or copying all or a part of this instruction manual without permission is prohibited.
- The company names, names of products and trademarks of each company shown in the sentences are registered trademarks.

RC ROBO
CYLINDER

Table of Contents

Safety Guide	1
Caution in Handling	8
International Standards Compliances	9
Names of the Parts	10
1. Specifications Check.....	11
1.1 Checking the Product.....	11
1.1.1 Parts	11
1.1.2 Related Instruction Manuals for the Each Controller Supported by This Product.....	11
1.1.3 How to Read the Model Nameplate	11
1.1.4 How to Read the Model Number.....	12
1.2 Specifications	13
1.2.1 Speed	13
1.2.2 Speed and Payload	14
1.2.3 Driving System • Position Detector	18
1.2.4 Positioning Precision.....	18
1.2.5 Allowable Moment for Actuator	19
1.3 Options.....	20
1.3.1 Brake Type (Model: B)	20
1.3.2 Reversed-home Specification (Model: NM)	20
1.3.3 Cable Eject Direction Changed (Model: CJT, CJR, C JL, CJB).....	20
1.3.4 Ceiling Mount Type (Model: CIM), Left Horizontally Oriented Wall Mount Type (Model: SIL) and Right Horizontally Oriented Wall Mount Type (Model: SIR).	20
1.4 Motor • Encoder Cables	21
1.4.1 Motor • Encoder Integrated Cables.....	21
1.4.2 Motor • Encoder Integrated Cables Robot Type	22
2. Installation.....	23
2.1 Transportation	23
2.2 Installation and Storage • Preservation Environment.....	25
2.3 How to Install.....	26
2.3.1 Installation Orientation	26
2.3.2 Installation	27
3. Connecting with the Controller.....	32
4. Maintenance and Inspection	36
4.1 Inspection Items and Schedule	36
4.2 External Visual Inspection	37
4.3 Cleaning	37
4.4 Internal Inspections	37
4.4.1 Check Condition and Dirt of Lubricant	38
4.4.2 Inspection of the Belt.....	39
4.5 Internal Cleaning	40
4.6 Grease Supply.....	40
4.6.1 What Grease to Use.....	40
4.6.2 How to Apply Grease	41
4.7 Procedures for Replacement and Adjustment of Stainless Steel Sheet	44
4.7.1 Preparation.....	44
4.7.2 Procedure for Replacement and Tuning	45

4.8	Procedure for Belt Replacement and Tuning	48
4.8.1	Tension Adjustment	48
4.8.2	Replacement of the Belt.....	51
4.9	Replacement Process	60
5.	External Dimensions	73
5.1	RCP5-BA4/BA4U	73
5.2	RCP5-BA6/BA6U	74
5.3	RCP5-BA7/BA7U	75
6.	Life.....	76
6.1	How to Calculate Operation Life	76
6.2	Operation Life.....	77
7.	Warranty	78
7.1	Warranty Period.....	78
7.2	Scope of the Warranty.....	78
7.3	Honoring the Warranty	78
7.4	Limited Liability.....	78
7.5	Conditions of Conformance with Applicable Standards/Regulations, Etc., and Applications	79
7.6	Other Items Excluded from Warranty	79
	Change History	80

Safety Guide

“Safety Guide” has been written to use the machine safely and so prevent personal injury or property damage beforehand. Make sure to read it 1before the operation of this product.

Safety Precautions for Our Products

The common safety precautions for the use of any of our robots in each operation.

No.	Operation Description	Description
1	Model Selection	<ul style="list-style-type: none"> ● This product has not been planned and designed for the application where high level of safety is required, so the guarantee of the protection of human life is impossible. Accordingly, do not use it in any of the following applications. <ol style="list-style-type: none"> 1) Medical equipment used to maintain, control or otherwise affect human life or physical health. 2) Mechanisms and machinery designed for the purpose of moving or transporting people (For vehicle, railway facility or air navigation facility) 3) Important safety parts of machinery (Safety device, etc.) ● Do not use the product outside the specifications. Failure to do so may considerably shorten the life of the product. ● Do not use it in any of the following environments. <ol style="list-style-type: none"> 1) Location where there is any inflammable gas, inflammable object or explosive 2) Place with potential exposure to radiation 3) Location with the ambient temperature or relative humidity exceeding the specification range 4) Location where radiant heat is added from direct sunlight or other large heat source 5) Location where condensation occurs due to abrupt temperature changes 6) Location where there is any corrosive gas (sulfuric acid or hydrochloric acid) 7) Location exposed to significant amount of dust, salt or iron powder 8) Location subject to direct vibration or impact ● For an actuator used in vertical orientation, select a model which is equipped with a brake. If selecting a model with no brake, the moving part may drop when the power is turned OFF and may cause an accident such as an injury or damage on the work piece.

No.	Operation Description	Description
2	Transportation	<ul style="list-style-type: none"> ● When carrying a heavy object, do the work with two or more persons or utilize equipment such as crane. ● When the work is carried out with 2 or more persons, make it clear who is to be the leader and who to be the follower(s) and communicate well with each other to ensure the safety of the workers. ● When in transportation, consider well about the positions to hold, weight and weight balance and pay special attention to the carried object so it would not get hit or dropped. ● Transport it using an appropriate transportation measure. The actuators available for transportation with a crane have eyebolts attached or there are tapped holes to attach bolts. Follow the instructions in the instruction manual for each model. ● Do not step or sit on the package. ● Do not put any heavy thing that can deform the package, on it. ● When using a crane capable of 1t or more of weight, have an operator who has qualifications for crane operation and sling work. ● When using a crane or equivalent equipments, make sure not to hang a load that weighs more than the equipment's capability limit. ● Use a hook that is suitable for the load. Consider the safety factor of the hook in such factors as shear strength. ● Do not get on the load that is hung on a crane. ● Do not leave a load hung up with a crane. ● Do not stand under the load that is hung up with a crane.
3	Storage and Preservation	<ul style="list-style-type: none"> ● The storage and preservation environment conforms to the installation environment. However, especially give consideration to the prevention of condensation. ● Store the products with a consideration not to fall them over or drop due to an act of God such as earthquake.
4	Installation and Start	<p>(1) Installation of Robot Main Body and Controller, etc.</p> <ul style="list-style-type: none"> ● Make sure to securely hold and fix the product (including the work part). A fall, drop or abnormal motion of the product may cause a damage or injury. Also, be equipped for a fall-over or drop due to an act of God such as earthquake. ● Do not get on or put anything on the product. Failure to do so may cause an accidental fall, injury or damage to the product due to a drop of anything, malfunction of the product, performance degradation, or shortening of its life. ● When using the product in any of the places specified below, provide a sufficient shield. <ol style="list-style-type: none"> 1) Location where electric noise is generated 2) Location where high electrical or magnetic field is present 3) Location with the mains or power lines passing nearby 4) Location where the product may come in contact with water, oil or chemical droplets

No.	Operation Description	Description
4	Installation and Start	<p>(2) Cable Wiring</p> <ul style="list-style-type: none"> ● Use our company's genuine cables for connecting between the actuator and controller, and for the teaching tool. ● Do not scratch on the cable. Do not bend it forcibly. Do not pull it. Do not coil it around. Do not insert it. Do not put any heavy thing on it. Failure to do so may cause a fire, electric shock or malfunction due to leakage or continuity error. ● Perform the wiring for the product, after turning OFF the power to the unit, so that there is no wiring error. ● When the direct current power (+24V) is connected, take the great care of the directions of positive and negative poles. If the connection direction is not correct, it might cause a fire, product breakdown or malfunction. ● Connect the cable connector securely so that there is no disconnection or looseness. Failure to do so may cause a fire, electric shock or malfunction of the product. ● Never cut and/or reconnect the cables supplied with the product for the purpose of extending or shortening the cable length. Failure to do so may cause the product to malfunction or cause fire. <p>(3) Grounding</p> <ul style="list-style-type: none"> ● The grounding operation should be performed to prevent an electric shock or electrostatic charge, enhance the noise-resistance ability and control the unnecessary electromagnetic radiation. ● For the ground terminal on the AC power cable of the controller and the grounding plate in the control panel, make sure to use a twisted pair cable with wire thickness 0.5mm² (AWG20 or equivalent) or more for grounding work. For security grounding, it is necessary to select an appropriate wire thickness suitable for the load. Perform wiring that satisfies the specifications (electrical equipment technical standards). ● Perform Class D Grounding (former Class 3 Grounding with ground resistance 100Ω or below).





No.	Operation Description	Description
4	Installation and Start	<p>(4) Safety Measures</p> <ul style="list-style-type: none"> ● When the work is carried out with 2 or more persons, make it clear who is to be the leader and who to be the follower(s) and communicate well with each other to ensure the safety of the workers. ● When the product is under operation or in the ready mode, take the safety measures (such as the installation of safety and protection fence) so that nobody can enter the area within the robot's movable range. When the robot under operation is touched, it may result in death or serious injury. ● Make sure to install the emergency stop circuit so that the unit can be stopped immediately in an emergency during the unit operation. ● Take the safety measure not to start up the unit only with the power turning ON. Failure to do so may start up the machine suddenly and cause an injury or damage to the product. ● Take the safety measure not to start up the machine only with the emergency stop cancellation or recovery after the power failure. Failure to do so may result in an electric shock or injury due to unexpected power input. ● When the installation or adjustment operation is to be performed, give clear warnings such as "Under Operation; Do not turn ON the power!" etc. Sudden power input may cause an electric shock or injury. ● Take the measure so that the work part is not dropped in power failure or emergency stop. ● Wear protection gloves, goggle or safety shoes, as necessary, to secure safety. ● Do not insert a finger or object in the openings in the product. Failure to do so may cause an injury, electric shock, damage to the product or fire. ● When releasing the brake on a vertically oriented actuator, exercise precaution not to pinch your hand or damage the work parts with the actuator dropped by gravity.
5	Teaching	<ul style="list-style-type: none"> ● When the work is carried out with 2 or more persons, make it clear who is to be the leader and who to be the follower(s) and communicate well with each other to ensure the safety of the workers. ● Perform the teaching operation from outside the safety protection fence, if possible. In the case that the operation is to be performed unavoidably inside the safety protection fence, prepare the "Stipulations for the Operation" and make sure that all the workers acknowledge and understand them well. ● When the operation is to be performed inside the safety protection fence, the worker should have an emergency stop switch at hand with him so that the unit can be stopped any time in an emergency. ● When the operation is to be performed inside the safety protection fence, in addition to the workers, arrange a watchman so that the machine can be stopped any time in an emergency. Also, keep watch on the operation so that any third person can not operate the switches carelessly. ● Place a sign "Under Operation" at the position easy to see. ● When releasing the brake on a vertically oriented actuator, exercise precaution not to pinch your hand or damage the work parts with the actuator dropped by gravity. <p>* Safety protection Fence : In the case that there is no safety protection fence, the movable range should be indicated.</p>

No.	Operation Description	Description
6	Trial Operation	<ul style="list-style-type: none"> ● When the work is carried out with 2 or more persons, make it clear who is to be the leader and who to be the follower(s) and communicate well with each other to ensure the safety of the workers. ● After the teaching or programming operation, perform the check operation one step by one step and then shift to the automatic operation. ● When the check operation is to be performed inside the safety protection fence, perform the check operation using the previously specified work procedure like the teaching operation. ● Make sure to perform the programmed operation check at the safety speed. Failure to do so may result in an accident due to unexpected motion caused by a program error, etc. ● Do not touch the terminal block or any of the various setting switches in the power ON mode. Failure to do so may result in an electric shock or malfunction.
7	Automatic Operation	<ul style="list-style-type: none"> ● Check before starting the automatic operation or rebooting after operation stop that there is nobody in the safety protection fence. ● Before starting automatic operation, make sure that all peripheral equipment is in an automatic-operation-ready state and there is no alarm indication. ● Make sure to operate automatic operation start from outside of the safety protection fence. ● In the case that there is any abnormal heating, smoke, offensive smell, or abnormal noise in the product, immediately stop the machine and turn OFF the power switch. Failure to do so may result in a fire or damage to the product. ● When a power failure occurs, turn OFF the power switch. Failure to do so may cause an injury or damage to the product, due to a sudden motion of the product in the recovery operation from the power failure.

No.	Operation Description	Description
8	Maintenance and Inspection	<ul style="list-style-type: none"> ● When the work is carried out with 2 or more persons, make it clear who is to be the leader and who to be the follower(s) and communicate well with each other to ensure the safety of the workers. ● Perform the work out of the safety protection fence, if possible. In the case that the operation is to be performed unavoidably inside the safety protection fence, prepare the “Stipulations for the Operation” and make sure that all the workers acknowledge and understand them well. ● When the work is to be performed inside the safety protection fence, basically turn OFF the power switch. ● When the operation is to be performed inside the safety protection fence, the worker should have an emergency stop switch at hand with him so that the unit can be stopped any time in an emergency. ● When the operation is to be performed inside the safety protection fence, in addition to the workers, arrange a watchman so that the machine can be stopped any time in an emergency. Also, keep watch on the operation so that any third person can not operate the switches carelessly. ● Place a sign “Under Operation” at the position easy to see. ● For the grease for the guide or ball screw, use appropriate grease according to the instruction manual for each model. ● Do not perform the dielectric strength test. Failure to do so may result in a damage to the product. ● When releasing the brake on a vertically oriented actuator, exercise precaution not to pinch your hand or damage the work parts with the actuator dropped by gravity. ● The slider or rod may get misaligned OFF the stop position if the servo is turned OFF. Be careful not to get injured or damaged due to an unnecessary operation. ● Pay attention not to lose the cover or untightened screws, and make sure to put the product back to the original condition after maintenance and inspection works. Use in incomplete condition may cause damage to the product or an injury. <p>* Safety protection Fence : In the case that there is no safety protection fence, the movable range should be indicated.</p>
9	Modification and Dismantle	<ul style="list-style-type: none"> ● Do not modify, disassemble, assemble or use of maintenance parts not specified based at your own discretion.
10	Disposal	<ul style="list-style-type: none"> ● When the product becomes no longer usable or necessary, dispose of it properly as an industrial waste. ● When removing the actuator for disposal, pay attention to drop of components when detaching screws. ● Do not put the product in a fire when disposing of it. The product may burst or generate toxic gases.
11	Other	<ul style="list-style-type: none"> ● Do not come close to the product or the harnesses if you are a person who requires a support of medical devices such as a pacemaker. Doing so may affect the performance of your medical device. ● See Overseas Specifications Compliance Manual to check whether complies if necessary. ● For the handling of actuators and controllers, follow the dedicated instruction manual of each unit to ensure the safety.

Alert Indication

The safety precautions are divided into “Danger”, “Warning”, “Caution” and “Notice” according to the warning level, as follows, and described in the instruction manual for each model.

Level	Degree of Danger and Damage	Symbol
Danger	This indicates an imminently hazardous situation which, if the product is not handled correctly, will result in death or serious injury.	 Danger
Warning	This indicates a potentially hazardous situation which, if the product is not handled correctly, could result in death or serious injury.	 Warning
Caution	This indicates a potentially hazardous situation which, if the product is not handled correctly, may result in minor injury or property damage.	 Caution
Notice	This indicates lower possibility for the injury, but should be kept to use this product properly.	 Notice

Caution in Handling

1. Make sure to follow the usage condition, environment and specification range of the product.
In case it is not secured, it may cause a drop in performance or malfunction of the product.
2. Do not attempt to have any handling or operation that is not stated in this Instruction manual.
3. It is recommended to apply our products for the wiring between the actuator and the controller.
4. Do not attempt to establish the settings for the speed and acceleration/deceleration above the allowable range.
An operation with speed and acceleration/deceleration beyond the allowable range may cause an abnormal noise, vibration, malfunction or shortened life.
5. Set the allowable moment within the allowable range.
If the robot is operated under a load equal to or greater than the allowable moment, abnormal noise or vibration, failure, or shorter life may result. If it is extreme, flaking may occur on the guide.
6. Set the overhang load length within the allowable range.
Attaching a load with an overhang load length above the allowable range may cause vibration and abnormal noise.
7. If back and forth operations are performed repeatedly in short distance, it may wear out the film of grease.
Continuous back and forth operation within a distance less than 30mm may cause wear of grease. As a reference, have approximately 5 cycles of back and forth operation in a distance more than 50mm in every 5,000 to 10,000 cycles to regenerate the oil film. Keep using the actuator with the grease worn out may cause malfunction. If it is extreme, flaking may occur on the guide.
8. The position will slightly move only in the first time of turning the servo on after the power is supplied.
In the first time to turn the servo on after the power is supplied only, position adjustment operation will be conducted due to the characteristics of the stepper motor. For this reason, the position will slightly move. The maximum amount of move is $0.025 \times \text{lead length [mm]}$.
Pay attention not to have peripheral equipment interfere.
9. Turn on the servo after making sure the slider is away from the mechanical end.
If the servo is turned on when the slider or rod is positioned near the mechanical end, the pole phase may not be detected and pole non-confirmation error or excitation detection error may occur. Set the slider away from the mechanical end.
10. Pressing operation cannot be performed.
11. Make sure to attach the actuator properly by following this instruction manual.
Using the product with the actuator not being certainly retained or affixed may cause abnormal noise, vibration, malfunction or shorten the product life.

International Standards Compliances

This actuator complies with the following overseas standard.
Refer to Overseas Standard Compliance Manual (ME0287) for more detailed information.

RoHS Directive	CE Marking
<input type="checkbox"/>	<input type="checkbox"/>

Names of the Parts

See figure below for BA4/BA6/BA7 (Motor upper mount).

For BA4U/BA6U/BA7U, the motor unit is mounted facing the lower side.

In this manual, the right and left sides of the actuator are expressed in the way it is placed horizontally as shown in the figure below, and is looked at from the motor side.

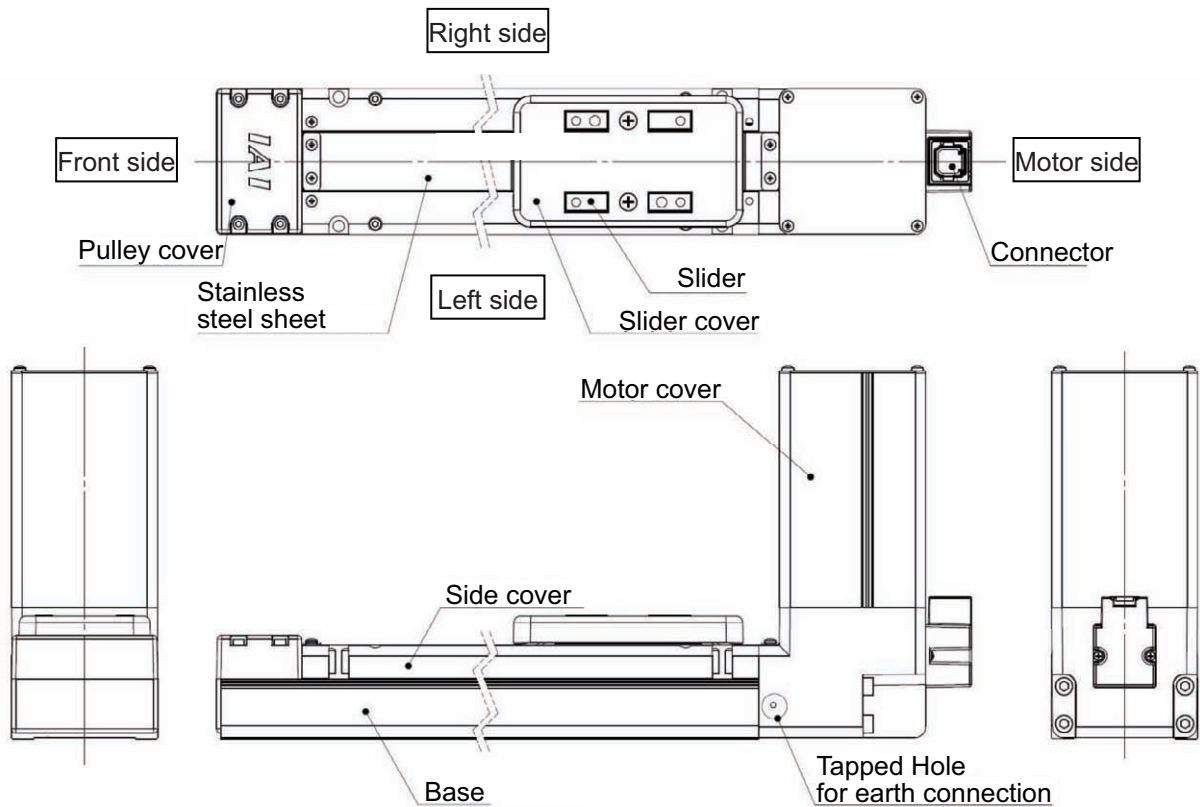

1. Specifications Check

1.1 Checking the Product

The standard configuration of this product is comprised of the following parts. See the component list for the details of the enclosed components. If you find any fault or missing parts, contact your local IAI distributor.

1.1.1 Parts

No.	Name	Model Number	Quantity	Remarks
1	Actuator	Refer to "How to Read the Model Nameplate" and "How to Read the Model Number."	1	
Accessories				
2	Motor • Encoder Cables ^(Note1)		1	
3	In-house Made Seals		1	
4	First Step Guide		1	
5	Instruction Manual (DVD)		1	
6	Safety Guide		1	

Note1 The motor • encoder cables supplied vary depending on the controller used.
[Refer to 1.4, "Motor • Encoder Cables."]

1.1.2 Related Instruction Manuals for the Each Controller Supported by This Product

Shown below is a list of the instruction manuals for the controllers related to this product which is recorded in Instruction Manual (DVD).

No.	Name	Control No.
1	Instruction Manual for PCON-CA/CFA Controller	ME0289
2	Instruction Manual for MSEP Controller	ME0299
3	Instruction Manual for MSEL Controller	ME0336
4	Instruction Manual for RC PC Software RCM-101-MW/RCM-101-USB	ME0155
5	Instruction Manual for Touch Panel Teaching Pendant CON-PTA/PDA/PGA	ME0295
6	Instruction Manual for Touch Panel Teaching Pendant TB-01/01D/01DR Applicable for Position Controller	ME0324

1.1.3 How to Read the Model Nameplate

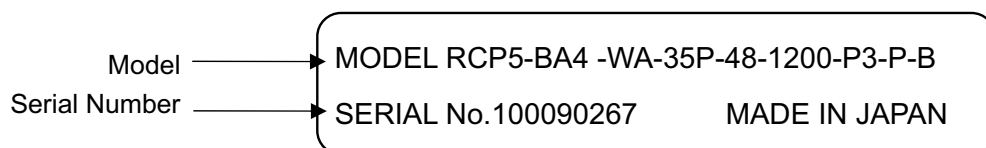

1.1.4 How to Read the Model Number

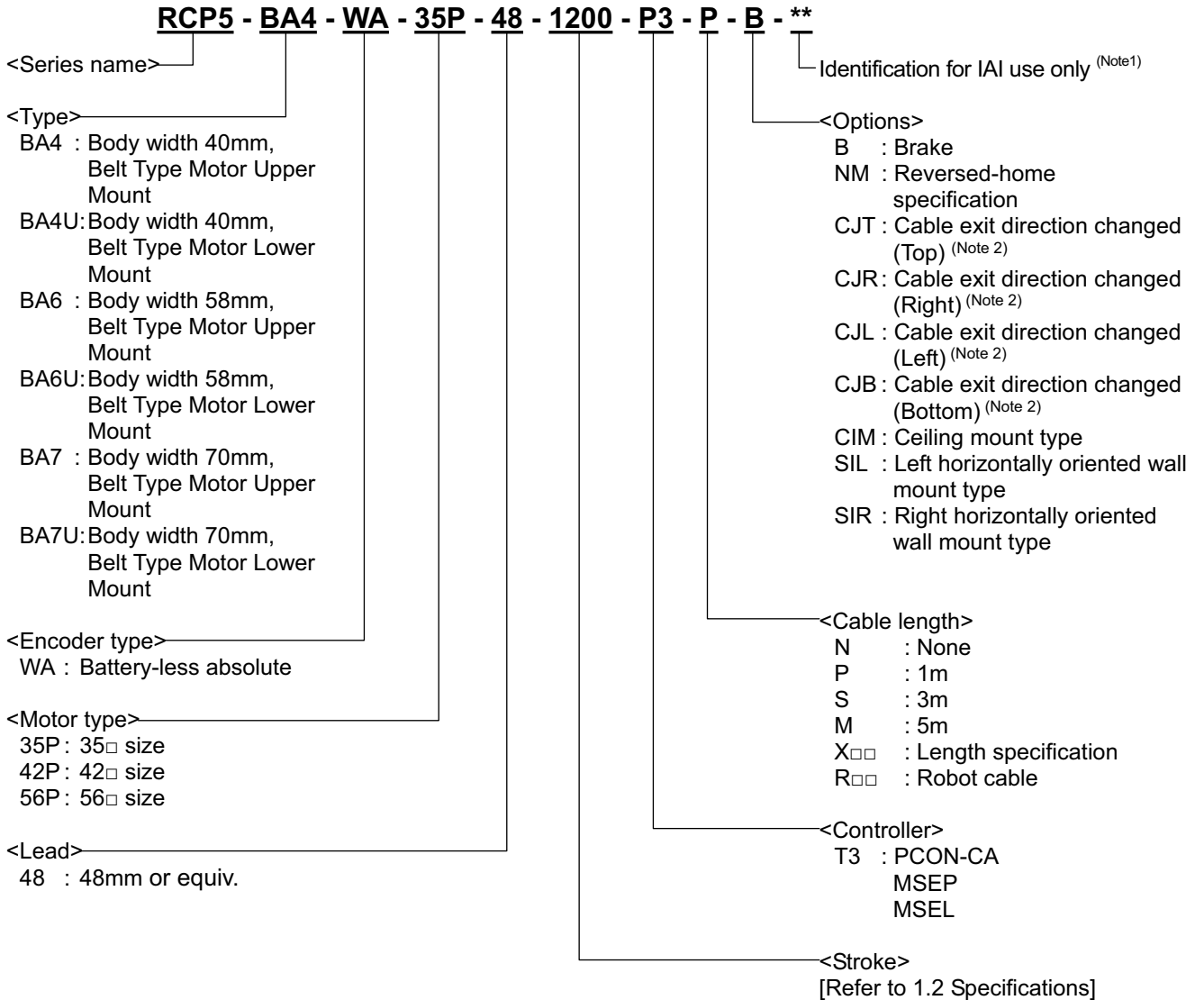

Note 1 Identification for IAI use only: It may be displayed for IAI use. It is not a code to show the model type.

Note 2 It is necessary to select either of CJT (Top), CJR (Right), CJL (Left) or CJB (Bottom) for the option to change the direction for cable ejection.

1.2 Specifications

1.2.1 Speed

[When high-output setting is effective] Speed limits [Unit: mm/s]

Size	Motor Type	Lead [mm]	Stroke [mm]																	
			300	400	500	600	700	800	900	1000	1100	1200	1300	1400	1500	1600	1700	1800	1900	
BA4 BA4U	35P	48 or equiv.	890	1040	1120	1160	1200						-	-	-	-	-	-	-	-
BA6 BA6U	42P	48 or equiv.	890	1070	1220	1340	1400	1440	1500											
BA7 BA7U	56P	48 or equiv.	890	1070	1220	1340	1450	1520	1550	1600										

Size	Motor Type	Lead [mm]	Stroke [mm]						
			2000	2100	2200	2300	2400	2500	2600
BA4 BA4U	35P	48 or equiv.	-	-	-	-	-	-	-
BA6 BA6U	42P	48 or equiv.	1500			-	-	-	-
BA7 BA7U	56P	48 or equiv.	1600						



Caution: Use the unit with velocity at 100mm/s or more (150mm/s or more for BA4/4U). Operation with 100mm/s or less (150mm/s or less for BA4/4U) may cause vibration or noise.

1.2.2 Speed and Payload

[When high-output setting is effective]

Type	Motor Type	Lead [mm]	Payload [kg]	
			Speed [mm/s]	Max. Acceleration Speed 0.5G
BA4 BA4U	35P	48 or equiv.	0	1.5
			200	1.5
			800	1.5
			1000	1
			1200	0.5
BA6 BA6U	42P	48 or equiv.	0	6
			600	6
			800	4
			1000	3
			1500	1
BA7 BA7U	56P	48 or equiv.	0	16
			100	16
			1000	5
			1400	2
			1600	2

[Speed and Payload]

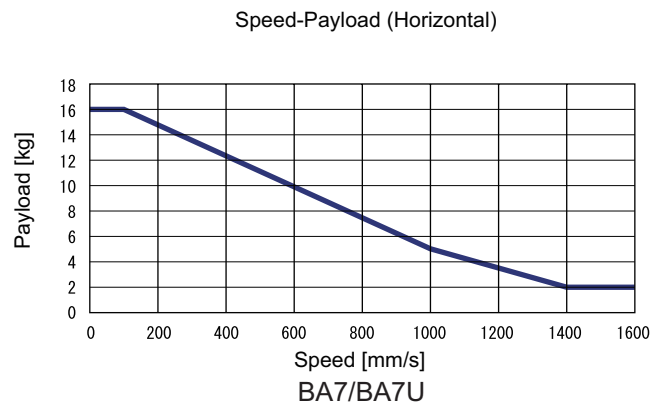
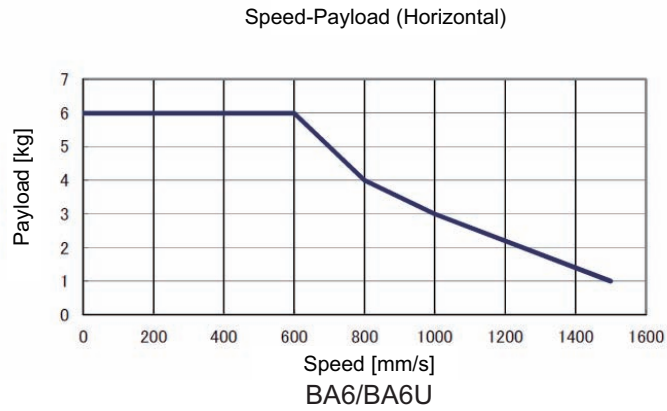
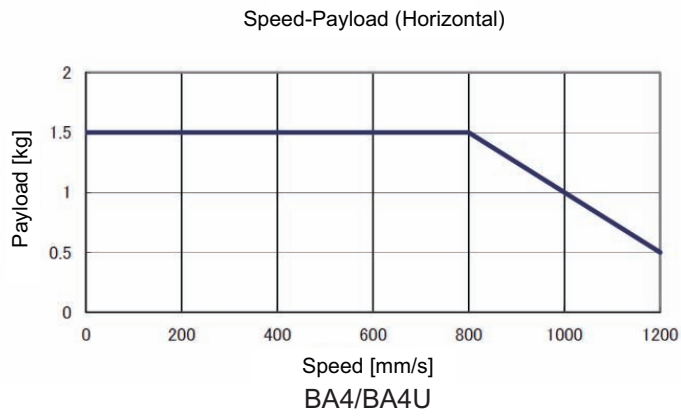

 **Caution:** Do not attempt to establish the settings for the acceleration/deceleration above the allowable range. It may cause vibration, malfunction or shortened life. Setting of acceleration/deceleration above the ratings may cause creeping.

[When high-output setting is ineffective]

Type	Motor Type	Lead [mm]	Payload [kg]	
			Speed [mm/s]	Max. Acceleration Speed 0.5G
BA4 BA4U	35P	48 or equiv.	0	1
			200	1
			800	1
			1000	1
			1200	0.5
BA6 BA6U	42P	48 or equiv.	0	3
			800	3
			1400	0.5
BA7 BA7U	56P	48 or equiv.	0	14
			100	14
			400	10
			800	5
			1200	1

[Speed and Payload]

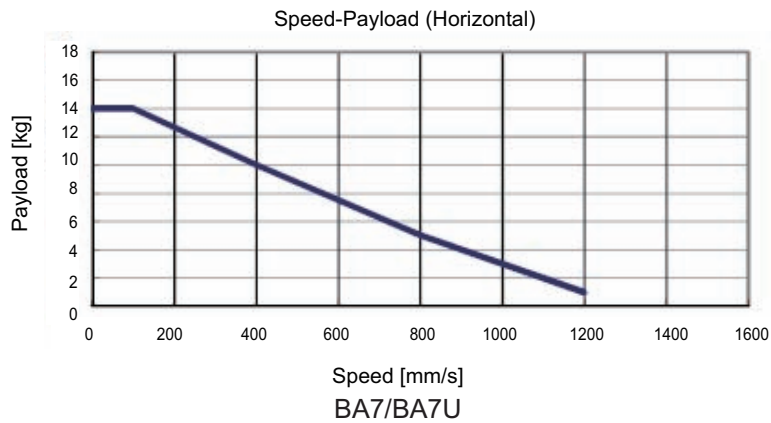
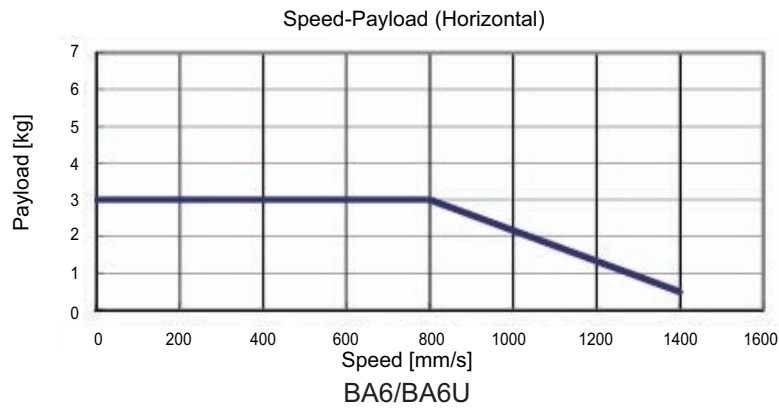
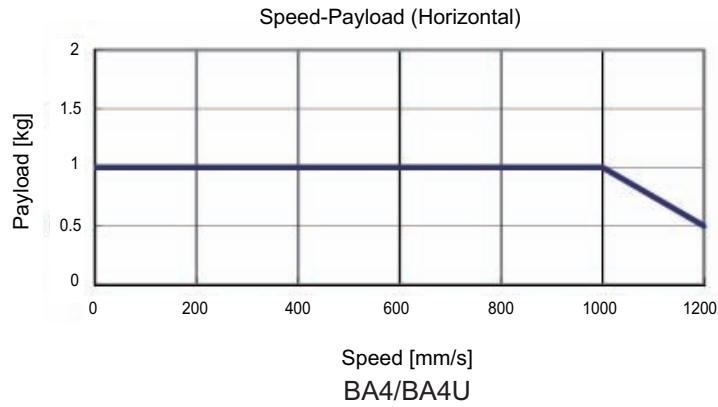

Caution: Do not attempt to establish the settings for the acceleration/deceleration above the allowable range. It may cause vibration, malfunction or shortened life. Setting of acceleration/deceleration above the ratings may cause creeping.

1.2.3 Driving System • Position Detector

Type	Motor Type	Lead	No. of Encoder Pulses
BA4 BA4U	35P	48 or equiv.	800
BA6 BA6U	42P	48 or equiv.	
BA7 BA7U	56P	48 or equiv.	

1.2.4 Positioning Precision

Type	Lead	Item	Tolerance
BA4 BA4U	48 or equiv.	Positioning repeatability	±0.08mm
		Lost motion	0.1mm or less
BA6 BA6U	48 or equiv.	Positioning repeatability	±0.08mm
		Lost motion	0.1mm or less
BA7 BA7U	48 or equiv.	Positioning repeatability	±0.08mm
		Lost motion	0.1mm or less

This is an option already attached when it is shipped out from the factory.
It does not include the consideration of time-dependent change as it is used.

1.2.5 Allowable Moment for Actuator

Type	Allowable Static Load Moment [N•m]			Allowable Dynamic Load Moment [N•m]			Allowable Overhang Load Length [L]
	Ma	Mb	Mc	Ma	Mb	Mc	
BA4 BA4U	16	16	31.2	6.14	6.14	11.9	Ma direction: 120mm Mb, Mc direction: 120mm
BA6 BA6U	44.5	44.5	89.2	15.7	15.7	31.6	Ma direction: 150mm Mb, Mc direction: 150mm
BA7 BA7U	80.7	80.7	175	33.2	33.2	72.3	Ma direction: 180mm Mb, Mc direction: 180mm

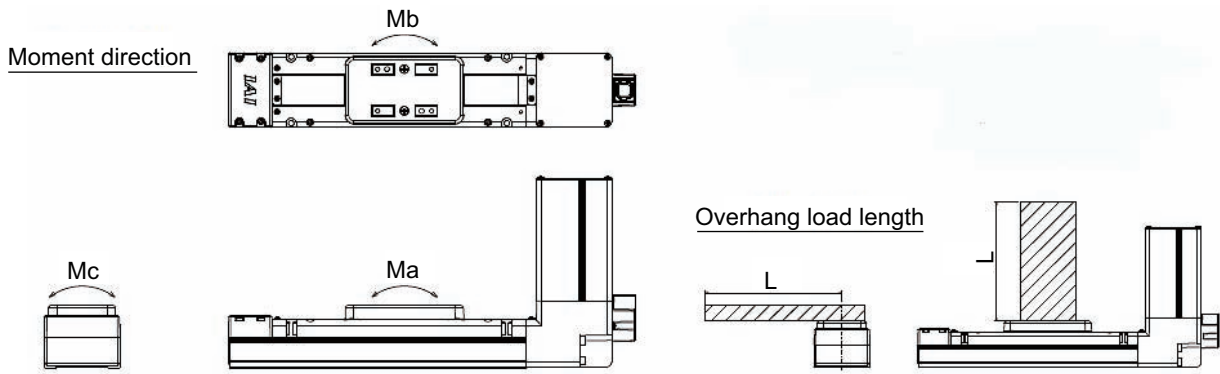

- Ma and Mb Direction Moment Offset Datum Position

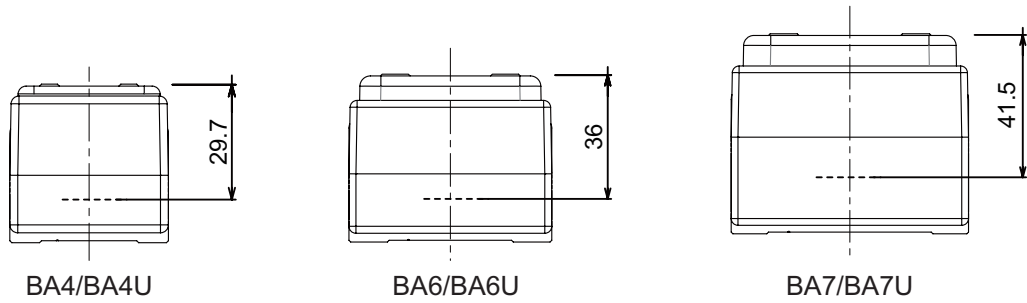

1.3 Options

1.3.1 Brake Type (Model: B)

This is a feature to retain the slider so it would not move when the power or servo is turned OFF.

1.3.2 Reversed-home Specification (Model: NM)

The standard home position is on the motor side. However, the motor position will be reversed if it is desirable in view of the layout of the system, etc.

(Note) The home position is adjusted at the factory before shipment. If you wish to change the home after the delivery of your actuator, you must return the actuator to IAI for adjustment.

1.3.3 Cable Eject Direction Changed (Model: CJT, CJR, CJL, CJB)

If a change in the cable ejection direction is made, the direction of cable ejection will be changed.

There are ejection directions, top (model: CJT), right (model: CJR), left (model: CJL) and bottom (model: CJB).

It is necessary to select either of CJT, CJR, CJL or CJB for this option.

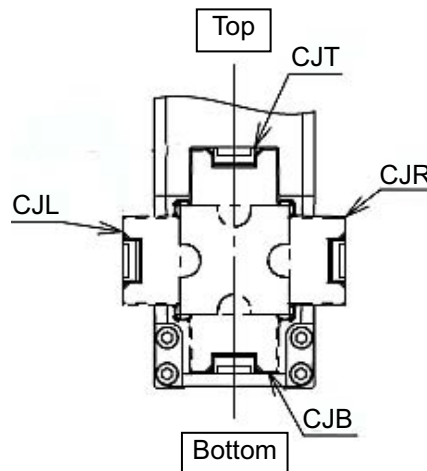

1.3.4 Ceiling Mount Type (Model: CIM), Left Horizontally Oriented Wall Mount Type (Model: SIL) and Right Horizontally Oriented Wall Mount Type (Model: SIR).

It is an option that the actuator is adjusted so it can be installed in ceiling mount, horizontally oriented wall mount with the motor unit on the left or horizontally oriented wall mount with the motor unit on the right. The model codes are ceiling mount type (model: CIM), left horizontally oriented wall mount type (model: SIL) and right horizontally oriented wall mount type (model: SIR).

(Note) Standard horizontal orientation type and ceiling mount type cannot be installed in horizontally oriented wall mount. Also, horizontally oriented wall mount type cannot be installed in standard horizontal orientation or ceiling mount.

[Left and Right Horizontally Oriented Wall Mount Types]

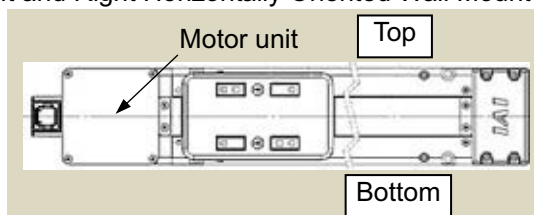

Left horizontally oriented wall mount type
(model: SIL)

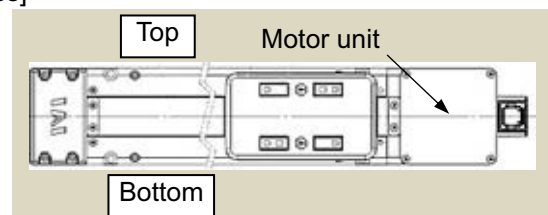

Right horizontally oriented wall mount type
(model: SIR)

1.4 Motor • Encoder Cables

1.4.1 Motor • Encoder Integrated Cables

CB-CAN-MPA□□□

□□□ indicates the cable length L (Example. 030 = 3m). Max.20m

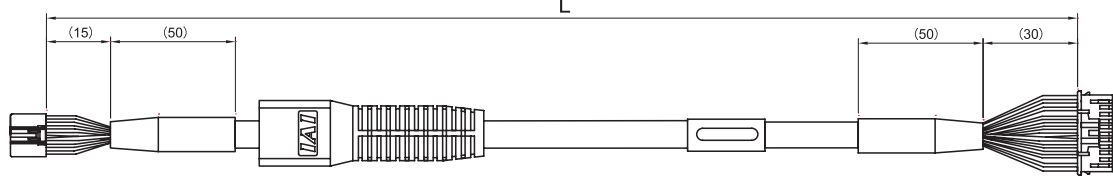

Actuator side

Connector: DF62B-24S-2.2C
Contact: DF62-2428SCFA (AWG26)
DF62-22SCFA (AWG22)

Controller side

Connector: PADP-24V-1-S
Contact: SPND-002T-C0.5 (AWG26)
SPND-001T-C0.5 (AWG22)

Connection diagram

Actuator side

Thickness	Electric Wire Color	Signal Name	Pin No.
AWG22/19	Blue	ϕ A	3
AWG22/19	Orange	VMM	5
AWG22/19	Brown	ϕ B	10
AWG22/19	Gray	VMM	9
AWG22/19	Green	ϕ _A	4
AWG22/19	Red	ϕ _B	15
AWG26	Black	LS+	8
AWG26	Yellow	LS-	14
AWG26	Blue	SA	12
AWG26	Orange	SB	17
AWG26	Green	A+	1
AWG26	Brown	A-	6
AWG26	Gray	B+	11
AWG26	Red	B-	16
AWG26	Blue	BK+	20
AWG26	Orange	BK-	2
AWG26	Gray	VCC	21
AWG26	Red	GND	7
AWG26	Brown	VPS	18
AWG26	Green	LS_GND	13
-	-	-	19
AWG26	Pink	-	22
-	-	-	23
AWG26	Black	FG	24

Controller side

Pin No.	Signal Name	Electric Wire Color	Thickness
1	ϕ A	Blue	AWG22/19
2	VMM	Orange	AWG22/19
3	ϕ B	Brown	AWG22/19
4	VMM	Gray	AWG22/19
5	ϕ _A	Green	AWG22/19
6	ϕ _B	Red	AWG22/19
7	LS+	Black	AWG26
8	LS-	Yellow	AWG26
11	SA	Blue	AWG26
12	SB	Orange	AWG26
13	A+	Green	AWG26
14	A-	Brown	AWG26
15	B+	Gray	AWG26
16	B-	Red	AWG26
9	BK+	Blue	AWG26
10	BK-	Orange	AWG26
17	VCC	Gray	AWG26
19	GND	Red	AWG26
18	VPS	Brown	AWG26
20	LS_GND	Green	AWG26
22	-	-	-
21	-	Pink	AWG26
23	-	-	-
24	FG	Black	AWG26

(Note) About thickness AWG22/19

The thickness is AWG22 when the cable length is 5m or less, and AWG19 when longer than 5m.

1.4.2 Motor • Encoder Integrated Cables Robot Type

CB-CAN-MPA□□□-RB

□□□ indicates the cable length L (Example. 030 = 3m). Max.20m

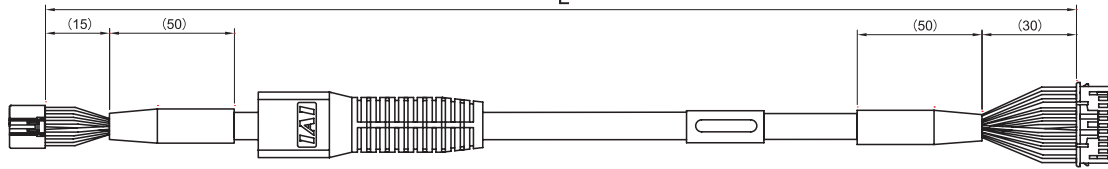

Actuator side

Connector: DF62B-24S-2.2C
Contact: DF62-2428SCFA (AWG26)
DF62-22SCFA (AWG22)

Controller side

Connector: PADP-24V-1-S
Contact: SPND-002T-C0.5 (AWG26)
SPND-001T-C0.5 (AWG22)

Connection diagram

Actuator side

Thickness	Electric Wire Color	Signal Name	Pin No.
AWG22/19	Blue	ϕ A	3
AWG22/19	Orange	VMM	5
AWG22/19	Brown	ϕ B	10
AWG22/19	Gray	VMM	9
AWG22/19	Green	ϕ A	4
AWG22/19	Red	ϕ B	15
AWG26	Black	LS+	8
AWG26	Yellow	LS-	14
AWG26	Blue	SA	12
AWG26	Orange	SB	17
AWG26	Green	A+	1
AWG26	Brown	A-	6
AWG26	Gray	B+	11
AWG26	Red	B-	16
AWG26	Blue	BK+	20
AWG26	Orange	BK-	2
AWG26	Gray	VCC	21
AWG26	Red	GND	7
AWG26	Brown	VPS	18
AWG26	Green	LS_GND	13
-	-	-	19
AWG26	Pink	-	22
-	-	-	23
AWG26	Black	FG	24

Controller side

Pin No.	Signal Name	Electric Wire Color	Thickness
1	ϕ A	Blue	AWG22/19
2	VMM	Orange	AWG22/19
3	ϕ B	Brown	AWG22/19
4	VMM	Gray	AWG22/19
5	ϕ A	Green	AWG22/19
6	ϕ B	Red	AWG22/19
7	LS+	Black	AWG26
8	LS-	Yellow	AWG26
11	SA	Blue	AWG26
12	SB	Orange	AWG26
13	A+	Green	AWG26
14	A-	Brown	AWG26
15	B+	Gray	AWG26
16	B-	Red	AWG26
9	BK+	Blue	AWG26
10	BK-	Orange	AWG26
17	VCC	Gray	AWG26
19	GND	Red	AWG26
18	VPS	Brown	AWG26
20	LS_GND	Green	AWG26
22	-	-	-
21	-	Pink	AWG26
23	-	-	-
24	FG	Black	AWG26

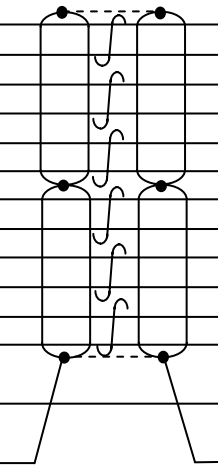

(Note) About thickness AWG22/19

The thickness is AWG22 when the cable length is 5m or less, and AWG19 when longer than 5m.

2. Installation

2.1 Transportation

[1] Handling of Robot

(1) Handling the Packed Unit

Unless otherwise specified, the actuator is shipped with each axis packaged separately.

- Do not damage or drop. The package is not applied with any special treatment that enables it to resist an impact caused by a drop or crash.
- Transport a heavy package with at least more than two operators. Consider an appropriate method for transportation.
- Keep the unit in horizontal orientation when placing it on the ground or transporting. Follow the instruction if there is any for the packaging condition
- Do not step or sit on the package.
- Do not put any load that may cause a deformation or breakage of the package. Pay attention especially on the stainless steel sheet not to apply any load on it.

(2) Handling the Actuator After Unpacking

- Do not carry an actuator by motor unit and a cable or attempt to move it by pulling the cable.
- Be careful not to bump the actuator into anything when moving it.
- Hold the body base when transporting the actuator.
- Do not apply an excessive force to each part of the actuator. In particular, prevent the motor unit and rear bracket from receiving an unnecessary force.

Supplement) For the names of each part of the actuator, refer to “Names of the Parts”

[2] Handling in the Assembled Condition

This is the case when the product is delivered from our factory under a condition that it is assembled with other actuators. The combined axes are delivered in a package that the frame is nailed on the lumber base. Fix the slider so that would not accidentally move during transportation. The actuators are also fixed so the tip of it would not shake due to the external vibration.

(1) How to Handle the Package

- Do not hit or drop the package. No special treatment is conducted on this package to endure a drop or impact on it.
- Do not attempt to carry a heavy package with only one worker. Also, have an appropriate method for transportation.
- When hanging up with ropes, support on the reinforcement frame on the bottom of the lumber base. When bringing up the package with a forklift, also support on the bottom of the lumber base.
- Handle with care when putting the package down to avoid impact or bounce.
- Do not step on the package.
- Do not put anything on the package that could deform or damage it.

(2) How to Handle after Unpackaged

- Secure the sliders to prevent sudden movement during transport.
- If the tip of an actuator is overhanging, have an appropriate way to fix it to avoid shake due to the external vibration. In the transportation without the tip being fixed, do not apply any impact with 0.3G or more.
- When hanging up with ropes, have appropriate cushioning to avoid any deformation of the actuator body. Also keep it in stable horizontal orientation. Make a fixture utilizing the attachment holes and the tapped holes on the actuator body if necessary.
- Do not attempt to apply load on the actuators or the connector box. Also pay attention not to pinch cables and bend or deform them forcefully.

[3] Handling in Condition of being assembled in Machinery Equipment (System)

These are some caution notes for when transporting the actuator being assembled in the machinery equipment (system):

- Fix the slider so that it would not move during transportation.
- If the tip of an actuator is overhanging, have an appropriate way to fix it to avoid shake due to the external vibration. In the transportation without the tip being fixed, do not apply any impact with 0.3G or more.
- When hanging up the machinery equipment (system) with ropes, do not attempt to apply load on the actuators or the connector box. Also pay attention not to pinch cables and bend or deform them forcefully.

2.2 Installation and Storage • Preservation Environment

[1] Installation Environment

The actuator should be installed in a location other than those specified below.

In general, the installation environment should be one in which an operator can work without protective gear.

Also provide sufficient work space required for maintenance inspection.

- Where the actuator receives radiant heat from strong heat sources such as heat treatment furnaces
- Where the ambient temperature exceeds the range of 0 to 40°C
- Where the temperature changes rapidly and condensation occurs
- Where the relative humidity exceeds 85% RH
- Where the actuator receives direct sunlight
- Where the actuator is exposed to corrosive or combustible gases
- Where the ambient air contains a large amount of powder dust, salt or iron (at level exceeding what is normally expected in an assembly plant)
- Where the actuator is subject to splashed water, oil (including oil mist or cutting fluid) or chemical solutions
- Where the actuator receives impact or vibration
- Where the altitude is more than 2000m

If the actuator is used in any of the following locations, provide sufficient shielding measures:

- Where noise generates due to static electricity, etc.
- Where the actuator is subject to a strong electric or magnetic field
- Where the actuator is subject to ultraviolet ray or radiation

[2] Storage • Preservation Environment

- The storage and preservation environment should comply with the same standards as those for the installation environment. In particular, when the machine is to be stored for a long time, pay close attention to environmental conditions so that no dew condensation forms.
- Unless specially specified, moisture absorbency protection is not included in the package when the machine is delivered. In the case that the machine is to be stored and preserved in an environment where dew condensation is anticipated, take the condensation preventive measures from outside of the entire package, or directly after opening the package.
- For storage and preservation temperature, the machine withstands temperatures up to 60°C for a short time, but in the case of the storage and preservation period of 1 month or more, control the temperature to 50°C or less.
- Storage and preservation should be performed in the horizontal condition. In the case it is stored in the packaged condition, follow the posture instruction if any displayed on the package.

2.3 How to Install

This chapter explains how to install the actuator on your mechanical system.

2.3.1 Installation Orientation

Follow the information below when installing the actuator, as a rule. Do pay attention to these items (except with custom-order models).

○ : Possible △ : Possible for stroke 1,000mm or less × : Not possible

Type	Horizontal Installation	Vertical Installation	Horizontally Oriented Wall Mount Installation	Ceiling Mount Installation
BA4/BA4U BA6/BA6U BA7/BA7U	○	×	△ (Note 1)	△ (Note 1)

Note 1 Optional

Installation Orientation

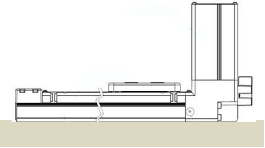
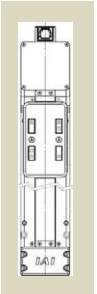
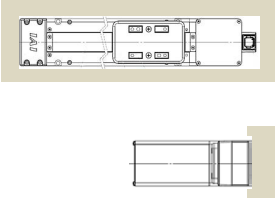
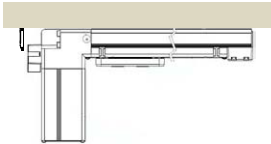
Horizontal	Vertical	Horizontally Oriented Wall Mount	Ceiling Mount
			



- Caution:**
- Do not attempt to install the standard horizontal orientation type or ceiling mount type in horizontally oriented wall mount. Also, do not attempt to install the horizontally oriented wall mount type in standard horizontal orientation or ceiling mount. Doing so may cause an operational error.
 - Do not attempt to have the unit tilted or installed in vertical orientation. It may cause an operational error.
 - Although it is available to install in horizontally oriented wall mount or ceiling mount, it is necessary to conduct daily inspection. Installation in horizontally oriented wall mount or ceiling mount may cause looseness on the stainless steel sheet. Continuing to use in such a condition may cause breakage of the stainless steel sheet. Have daily inspection, and adjust the stainless steel sheet attachment in case of any looseness found on it. [Refer to 4.7 Procedures for Replacement and Adjustment of Stainless Steel Sheet]

2.3.2 Installation

The surface to mount the main unit should be a machined surface or a plane that possesses an equivalent accuracy and the flatness should be within 0.05mm/m. Also, the platform should have a structure stiff enough to install the unit so it would not generate vibration or other abnormality.

Also consider enough space necessary for maintenance work such as actuator replacement and inspection.

On the base there is a datum surface prepared for the attachment oblong holes. The parallelism of the slider operation to the datum surface is 0.05mm/m or less.

On the back side of the actuator, there are attachment through holes, positioning reamed holes and oblong holes. For the details of the positions and dimensions, check in the appearance drawings. [Refer to 5. "External Dimensions"]

When repeatability in re-attaching is required after it is detached, utilize the reamed holes. Please note, however, that a consideration is necessary such as to use only one point on the motor side of the reamed holes when a fine-tuning such as perpendicularity is required.

[1] Installation of the Main Unit

This actuator is equipped with through holes on the base for installation from the top. (Be aware that the through holes size is different for each model. Refer to the figure below and "5. External Dimensions")

Avoid stainless steel sheet from getting any dent or scratch caused by dropping a bolt or tool on the sheet while fixing the unit with bolts.

Brake-equipped type ROBO Cylinder is capable to move the slider by its own.

Connect a controller and move the slider with JOG operation to perform installation.

As the attachment bolt, use hex socket head cap screws described in the table below.

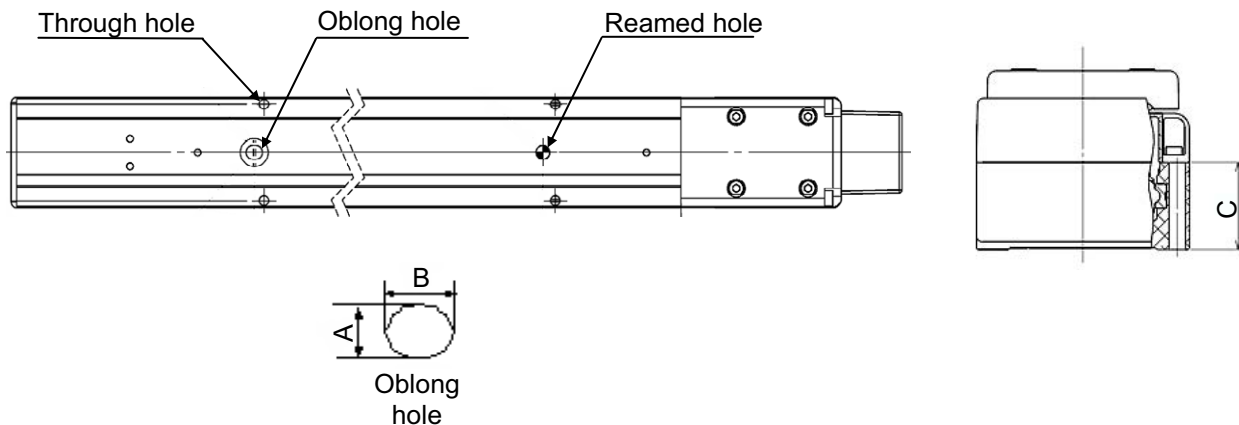

Type	Through Hole	Through Hole Depth: C	Mounting Screw	Tightening Torque	Reamed Hole [mm]	Oblong Hole
BA4 BA4U	φ 3.5 drilled hole	14	M3	0.83N•m (0.085kgf•m)	φ 5H7 depth 3	A:5H7 ^{+0.012} ₀ B:6 depth 3mm or less
BA6 BA6U	φ 4.5 drilled hole	16	M4	1.76N•m (0.18kgf•m)	φ 5H7 depth 3	A:5H7 ^{+0.012} ₀ B:6 depth 3mm or less
BA7 BA7U	φ 5.5 drilled hole	23.5	M5	3.42N•m (0.35kgf•m)	φ 5H7 depth 5	A:5H7 ^{+0.012} ₀ B:6 depth 5mm or less

Tightening Screws

- Use hexagonal socket head bolts for the male threads for installing the base.
- Use of high-tension bolts meeting at least ISO 10.9 is recommended.
- For the effective engagement length between the bolt and female thread, provide at least the applicable value specified below:
Female thread is made of steel material → Same length as the nominal diameter
Female thread is made of aluminum → 1.8 times of nominal diameter



Caution: Pay special attention when selecting the bolt length. In case that an inappropriate length of a bolt is applied, it may cause a drop in the operation accuracy or an unexpected accident due to a damage to the female thread, insufficient strength of actuator attachment or an interference with the operating area.

[2] Attachment of the Transported Object

- There are tapped holes on the top surface of the slider. Affix the transferred work piece on them.
- The way to affix follows the installation of the main unit.
- There are two reamed holes on the top surface of the slider. Use them in case it is necessary to have repeatability of attaching and detaching. Also, use only one reamed hole on the slider when fine-tuning such as perpendicularity is required.
- Refer to the table below for the thread depth and reamed depth. Screwing down further than the screw depths shown in the table below may destroy a tapped hole or cause a lack in the attachment strength of the transported object, which may result in the decrease in the accuracy or in a cause of an unexpected accident.
- For upper motor type, pay attention to the transferred work piece so it would not interfere with the motor (motor cover). [Refer to next page]

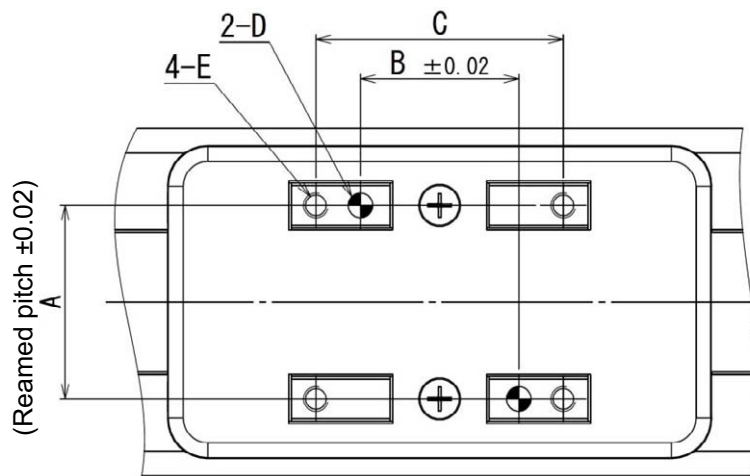

Type	A	B	C	D	E	Mounting screw	
						Screw Nominal Diameter	Tightening torque
BA4 BA4U	20	24	32	φ3H7 depth 6	M3 depth 7	M3	0.83N•m (0.085Kgf•m)
BA6 BA6U	31	32	50	φ5H7 depth 6	M5 depth 10	M5	3.42N•m (0.35Kgf•m)
BA7 BA7U	39	32	50	φ5H7 depth 10	M5 depth 10	M5	3.42N•m (0.35Kgf•m)

Tightening Screws

- Use hexagonal socket head bolts for the male threads for installing the attachment.
- Use of high-tension bolts meeting at least ISO 10.9 is recommended.
- Have 1.8 times or more of the nominal diameter secured for the effective length of thread engagement for screws and mating holes.



Caution: Pay attention when choosing the bolt length. Use of screws with inappropriate length may cause damage on the attachment holes or not sufficient strength of attachment of a transferred work piece.

[Distance between slider center and motor cover at mechanical end: A]

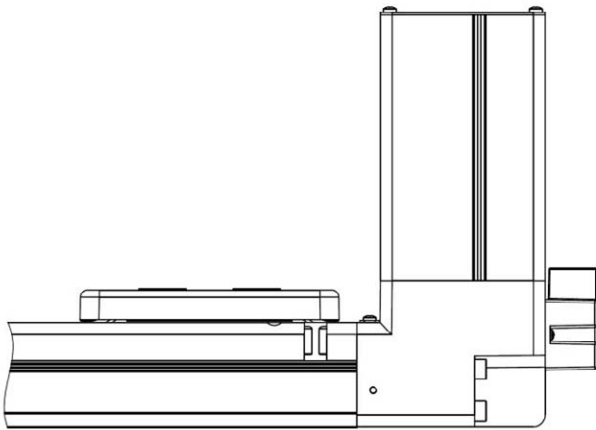
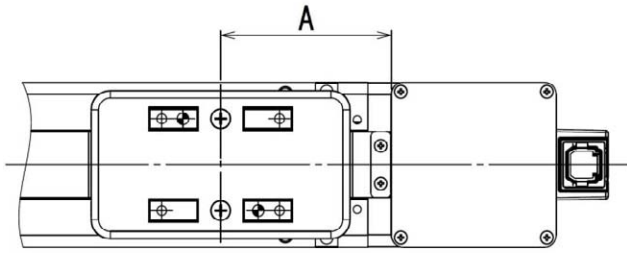

Type	A
BA4/BA4U	47
BA6/BA6U	66.5
BA7/BA7U	68.5

[3] Installation Surface

- Make sure the platform to install the actuator possesses a structure with sufficient stiffness, so vibration would not be generated.
- The surface where the actuator will be mounted should be a machined surface or that with an accuracy equivalent to it, and the flatness should be 0.05mm or below.
- Have enough space for the maintenance work.
- The side and bottom surfaces of the base on the actuator work as the datum surfaces for the side of the slider.
- Use these surfaces as the datum surfaces for mounting.

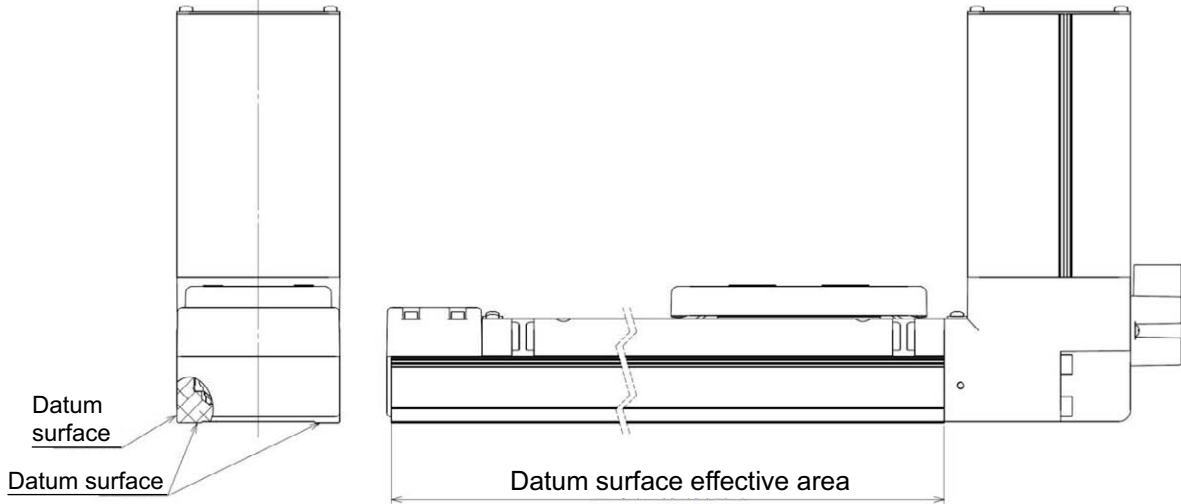

Follow the diagram below when installing the device using the reference surface.

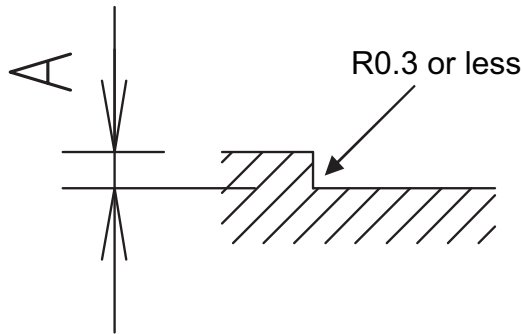

Type	A Dimensions [mm]
BA4/BA4U	3 to 5.5 or less
BA6/BA6U BA7/BA7U	3 to 6 or less

3. Connecting with the Controller

As the connection cable for the controller and RCS3 (this actuator), use the IAI-dedicated controller and dedicated connection cable.

This section explains the wiring method for a single axis.

- If the dedicated connection cable cannot be secured, reduce the load on the cable by allowing it to deflect only by the weight of the cable or wire it in a self-standing cable hose, etc., having a large radius.
- Do not cut and reconnect the dedicated connection cable for extension or shorten the cable.
- Do not pull on the dedicated connection cable or bend it forcibly.
- The actuator cable coming out of the motor unit is not meant to be bent. Fix the cable so it would not be bent repeatedly

Please consult with IAI if you require a different kind of cable than the one supplied.

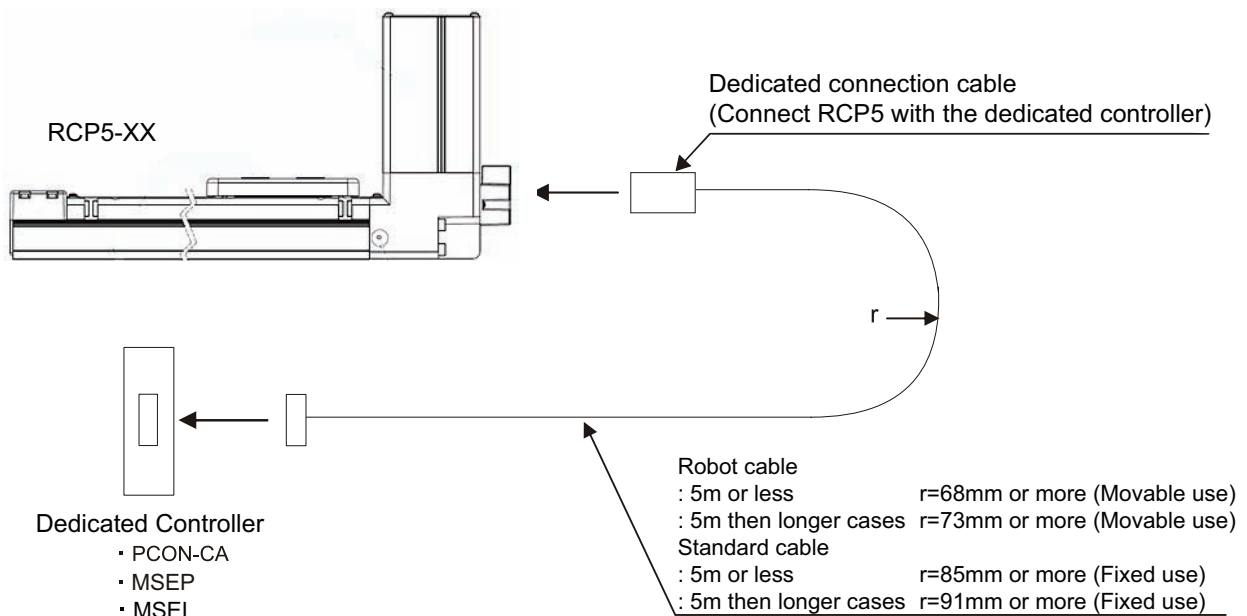

Dedicated connection cable

- Motor • encoder cables: CB-CAN-MPA□□□
- Motor • encoder cables robot type: CB-CAN-MPA□□□-RB

(Note) □□□ indicates the cable length. Up to 20m can be specified.

Example) 080=8m



Warning: For wiring, please follow the warnings stated below. When constructing a system as the machinery equipment, pay attention to the wiring and connection of each cable so they are conducted properly. Not following them may cause not only a malfunction such as cable breakage or connection failure, or an operation error, but also electric shock or electric leakage, or may even cause a fire.

- Use dedicated cables of IAI indicated in this instruction manual. Contact us if you wish to have a change to the specifications of the dedicated cables.
 - Make sure to turn the power off in the process of power line or cable connection or disconnection.
 - Do not attempt to cut a dedicated cable with connectors on both ends to extend, shorten or re-joint it.
 - Hold the dedicated cable to avoid mechanical force being applied to the terminals and connectors.
 - Use a cable pipe or duct to have an appropriate protection when there is a possibility of mechanical damage on a dedicated cable.
 - In case a dedicated cable is to be used at a moving part, make sure to lay out the cable without applying any force to pull the connector or extreme bend on the cable. Do not attempt to use the cable with a bending radius below the allowable value.
 - Make certain that the connectors are plugged properly. Insufficient connection may cause an operation error, thus it is extremely risky.
 - Do not lay out the cables to where the machine runs over them.
 - Pay attention to the cable layout so it would not hit peripherals during an operation. In case it does, have an appropriate protection such as a cable track.
 - When a cable is used hanging on the ceiling, prevent an environment that the cable swings with acceleration or wind velocity.
 - Make sure there is not too much friction inside the cable storage equipment.
 - Do not apply radiated heat to power line or cables.
 - Do not bend the cable in the area from the connector tip inward to 150mm on both ends.
- | | |
|----------------|------------------|
| Standard cable | CB-CAN-MPA□□□ |
| Robot cable | CB-CAN-MPA□□□-RB |

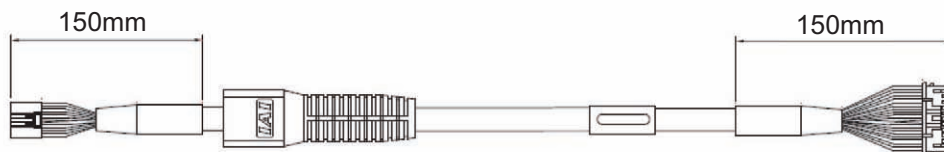

- Have a sufficient radius for bending, and avoid a bend concentrating on one point.

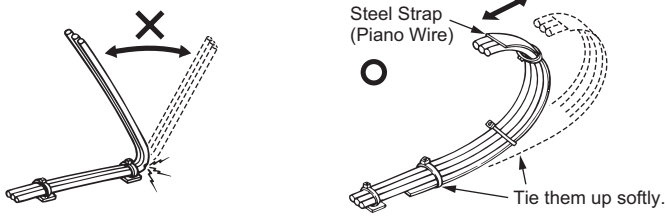

- Do not let the cable bend, kink or twist.

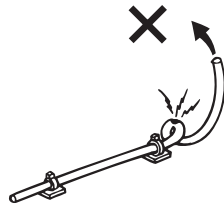

- Do not pull the cable with a strong force.

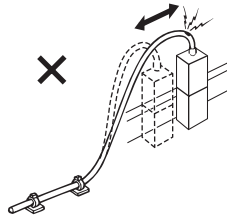

- Pay attention not to concentrate the twisting force to one point on a cable.

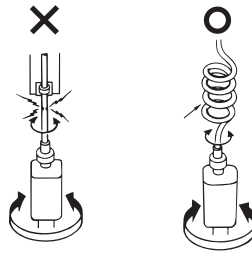

- Do not pinch, drop a heavy object onto or cut the cable.

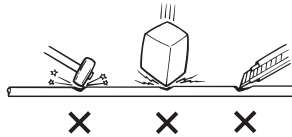

- When a cable is fastened to affix, make sure to have an appropriate force and do not tighten too much.

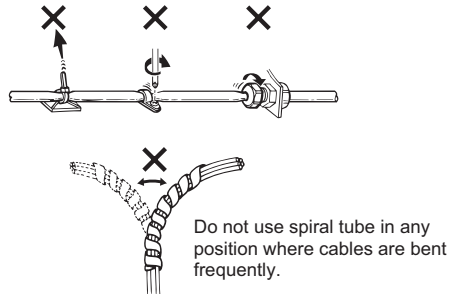

- PIO line, communication line, power and driving lines are to be put separately from each other and do not tie them together. Arrange so that such lines are independently routed in the duct.

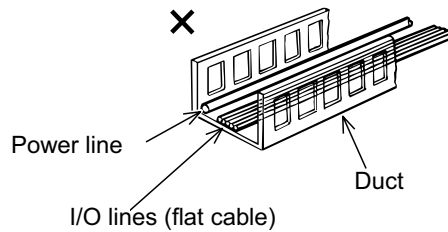

Follow the instructions below when using a cable track.

- If there is an indication to the cable for the space factor in a cable track, refer to the wiring instruction given by the supplier when storing the cable in the cable track.
- Avoid the cables to get twined or twisted in the cable track, and also to have the cables move freely and do not tie them up. (Avoid tension being applied when the cables are bent.) Do not pile up cables. It may cause faster abrasion of the sheaths or cable breakage.

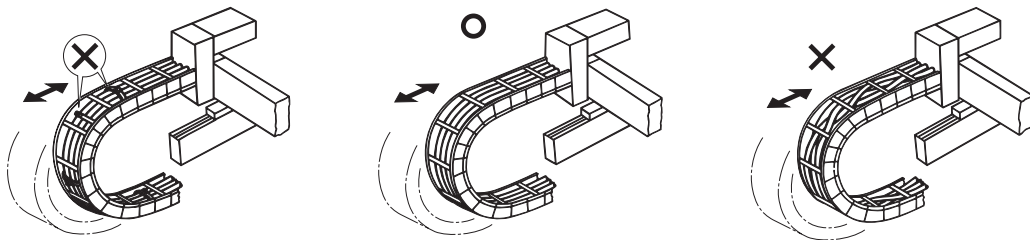

4. Maintenance and Inspection

4.1 Inspection Items and Schedule

Follow the maintenance inspection schedule below.

It is assumed that the equipment is operating 8 hours per day.

If the equipment is running continuously night and day or otherwise running at a high operating rate, inspect more often as needed.

	External Visual Inspection	Internal Inspection	Grease Supply (Note 1)	Tension Adjustment of the Belt
Start of work inspection	○ (Note 2)			
1 month inspection	○			
3 month inspection			○	
3 months after starting operation			Depends on period of grease supply (reference)	
6 month inspection	○	○ (Note 3)		
Every 6 month since	○	○ (Note 3)		
Every 1 year after operation started				○

Note 1 If the actuator are operated back and forth repeatedly over a distance of 30mm or less, the oil film created by the grease may be broken. As a guide, move the actuators back and forth repeatedly for around 5 cycles over a distance of 50mm or more after every 5,000 to 10,000 cycles. A layer of the grease will recover.

Note 2 Visually inspect the stainless sheet everyday for looseness, etc. Adjust the stainless steel sheet attachment in case of any looseness found on it.

[Refer to 4.7 "Procedures for Replacement and Adjustment of Stainless Steel Sheet"]

Note 3 Check the condition of grease, and wipe off the grease before supplying new in case it is extremely dirty.

[Grease Supply Timing of Guide (Reference)]

Perform grease supply when it has reached to either the operation distance or spent months described in the table below.

Maximum Speed of Use [mm/s]	Grease Supply Timing (Reference)	
	operated distance	Months
0 to 750 or less	1,250 km	12 month
750 to 1500	2,500 km	
1500 to 1600	5,000 km	

-  **Caution:**
- An actuator after 6 months of storage may have caused a degradation of the grease. Supply grease before start using. [Refer to 4.6 "Grease Supply"]
 - Degradation speed of grease may differ depending on the environment of use (temperature, humidity and ambient conditions). It is recommended to shorten the grease supply period if the actuator is used under a bad condition such as in high temperature, high humidity or in dusty ambience. Also, it is recommended to improve the environment conditions in case the grease changes its color due to the bad condition of use.

4.2 External Visual Inspection

An external visual inspection should check the following things.

Main Unit	Loose actuator mounting bolts, other loose items
Cables	Scratches, proper connections
Stainless steel sheet	Scratches
Overall	Irregular noise, vibration

- The life of the stainless steel sheet should be 5,000km of driving distance as a reference. However, replace the stainless steel sheet when it is necessary depending on the condition of use. The replacement work of the sheet is to be conducted basically in our factory or at the site by a service engineer that we send.

4.3 Cleaning

- Clean exterior surfaces as necessary.
- Use a soft cloth to wipe away dirt and buildup.
- Do not blow too hard with compressed air as it may cause dust to get in through the gaps.
- Do not use oil-based solvents as they can harm lacquered and painted surfaces.
- To remove severe buildup, wipe gently with a soft cloth soaked in a neutral detergent or alcohol.

4.4 Internal Inspections

Turn off the power, remove the side cover and inspect inside visually. When inspecting the interior, check the following items.

Guide Section	Lubrication, buildup
Long Belt	Refer to 4.4.2 Belt for inspection items.

4.4.1 Check Condition and Dirt of Lubricant

Visually inspect the interior of the equipment. Check whether dust or other foreign matter has gotten inside and check the lubrication state.

The lubrication may have turned brown. This is not a problem as long as the travel surfaces shine as though they are wet.

If the grease is mixed with dust and does not have a shiny appearance, or if the grease has lost its efficacy due to prolonged use, then clean each section and reapply grease.

The procedure for internal inspections is outlined below.

- 1) Remove the attachment screws (at arrows) on the side cover to detach the side cover on one side.

For some stroke patterns, there is another attachment screw on the side cover between two screws on right and left ends.

Make sure to remove them all.

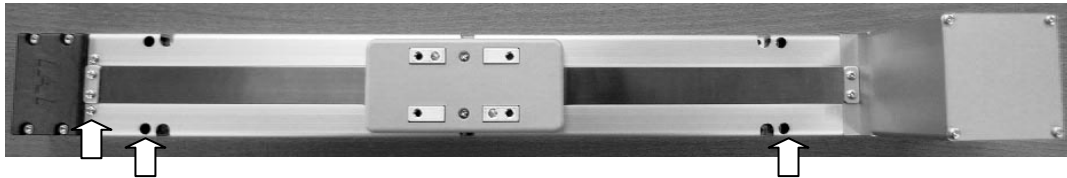

- 2) Check inside.
- 3) After inspection is finished, put the parts back on in the back order.
Hitting to the edge of the stainless steel sheet while attaching the side cover may cause damage or winding on the sheet, which could lead to earlier degradation or abrasion.
Therefore, to avoid a touch to the sheet edge, insert a shim (approx. 0.1 to 0.2mm) between the sheet and cover to put the sheet up when pushing in the cover.
Also, make sure to follow the notice of caution when attaching side covers described in the next page when side covers are attached.

When attaching the side covers, tighten the screws with the tightening torque described below.

Type	Bolt Diameter	Tightening Torque
BA4/BA4U	M2.6 hex socket head cap screw	45.8N•cm
	M3 cross recessed pan head machine screw	41.4N•cm
BA6/BA6U BA7/BA7U	M3 hex socket head cap screw	83.0N•cm
	M3 cross recessed pan head machine screw	41.4N•cm

 **Caution:** Pay attention not to have the stainless steel sheet bent forcefully or damaged when checking inside.
Do not attempt to pull the sheet to avoid a change of the attachment condition from the initial.
If the condition of attachment changes, it may impact the sheet position misalignment or its life. In such cases, contact the sales technical department in IAI.
Also, there is a risk of getting hurt on the edge of the stainless sheet. Make sure to have a safety countermeasure such as wearing gloves while working on.

4.4.2 Inspection of the Belt

After checking the lubrication and dirtiness on the guide part, check the belt visually.
As the durability of the belt gets influenced widely by the operation time, the period for replacement cannot be easily determined.

As the time of operation goes, degradation such as abrasion proceeds. Check the following items.

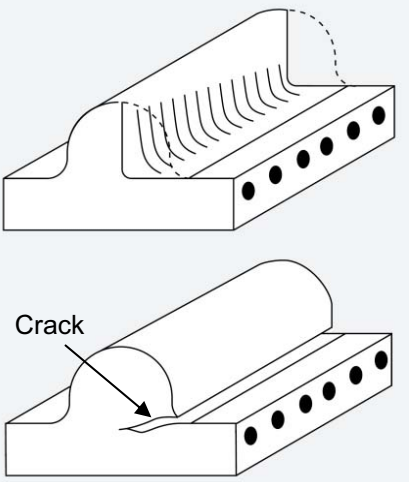
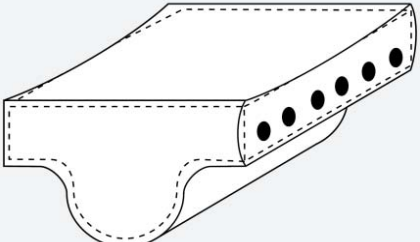
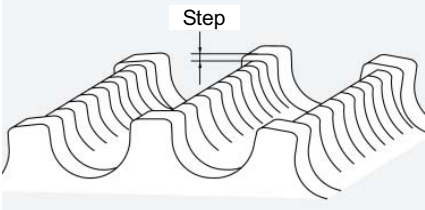
Items to Check	Check Contents
Breakage of belt	<ul style="list-style-type: none"> • Check if any breakage on belt
Abrasion, crack, tooth missing on belt 	<ul style="list-style-type: none"> • Check if any remarkable abrasion on teeth of the belt • Check if any crack on the root of a tooth • Check if any tooth missing
Hardening, softening and deformation of belt 	<ul style="list-style-type: none"> • Check if the belt is hardened, softened or deformed (shrunk or expanded)
Abrasion on pulley teeth 	<ul style="list-style-type: none"> • Check if any remarkable abrasion on pulley teeth.

Replace the belt if the situation suits to any of these below.

[Refer to 4.8 Procedure for Belt Replacement and Tuning]

- When an error was found in an inspection
- When back and forth operation reached 5,000,000 times ^(Note 1)

Note 1 The wires giving the toughness to the toothed belt are difficult to determine degradation by external visual. It is recommended to have a regular replacement cycle in every 5,000,000 times of back and forth operation or even more often in use under a condition strict to wire fatigue from high acceleration and deceleration.

4.5 Internal Cleaning

- Use a soft cloth to wipe away dirt and buildup.
- Do not blow too hard with compressed air as it may cause dust to get in through the gaps.
- Do not use oil-based solvents, neutral detergent or alcohol.

4.6 Grease Supply

4.6.1 What Grease to Use

IAI uses the following grease in our plant.

Guide	Kyodo Yushi	Multitemp LRL 3
-------	-------------	-----------------

Other companies also sell similar types of grease. For more detailed information, ask the supplier to find an equivalent for you by telling them the name of the grease.



Warning: Never use any fluorine-based grease. Mixing with lithium-based grease with other grease not only reduces the performance of the grease, it may even cause damage to the actuator.

4.6.2 How to Apply Grease

- 1) Remove the attachment screws (at arrows) on the side cover to detach the side cover on one side.

Screws: M2.5, M3 (BA4/BA4U), M3 (BA6/BA6U, BA7/BA7U)

For some stroke patterns, there is another attachment screw on the side cover between two screws on right and left ends.

Make sure to remove them all.



- 2) Use a spatula to push the grease in between the slider and the base, or supply grease with a grease injector and move the slider to spread the grease out evenly.
 - Confirm the ball feeding surface on the guide is glossy with oil of the grease. Do the same work again and again till the grease gets spread out enough.
 - In case excess grease has been applied, wipe it away.(Note) For brake-equipped type, connect a controller and operate it with JOG operation.

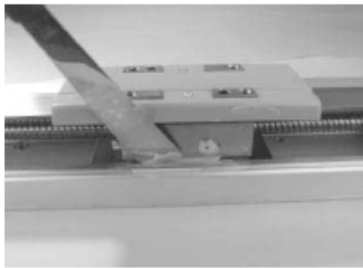

⚠ Caution: Supplying too much grease may increase sliding resistance and load to the motor, resulting in a drop of performance.

- 3) After grease supply is finished on one side, put back the side cover.
 Hitting it on the edge of the stainless steel sheet when attaching may cause the sheet damaged or meandered, which may result in earlier degradation or wear-out of the sheet.
 Therefore, to avoid a touch to the sheet edge, insert a shim (approx. 0.1 to 0.2mm) between the sheet and cover to put the sheet up when pushing in the cover.

When attaching the side covers, tighten the screws with the tightening torque described below.

Type	Bolt Diameter	Tightening Torque
BA4/BA4U	M2.6 hex socket head cap screw	45.8N•cm
	M3 cross recessed pan head machine screw	41.4N•cm
BA6/BA6U BA7/BA7U	M3 hex socket head cap screw	83.0N•cm
	M3 cross recessed pan head machine screw	41.4N•cm

⚠ Caution:

- Pay attention not to have the stainless steel sheet bent forcefully or damaged when working.
 Also, there is a risk of getting hurt on the edge of the stainless sheet. Make sure to have a safety countermeasure such as wearing gloves while working on.
- In case the grease got into your eye, immediately go see the doctor to get appropriate care. After finishing the grease supply work, wash your hands carefully with water and soap to rinse the grease off.

- 4) Next, supply grease to the guide on the other side. Remove the attachment screws (at arrows) on the side cover to detach the side cover on the other side.
 Bolt size: M2.5, M3 (BA4/BA4U), M3 (BA6/BA6U, BA7/BA7U)
 For some stroke patterns, there is another attachment screw on the side cover between two screws on right and left ends.
 Make sure to remove them all.



- 5) T Use a spatula to push the grease in between the slider and the base, or supply grease with a grease injector and move the slider to spread the grease out evenly.
- Confirm the ball feeding surface on the guide is glossy with oil of the grease. Do the same work again and again till the grease gets spread out enough.
 - In case excess grease has been applied, wipe it away.
- (Note) For brake-equipped type, connect a controller and operate it with JOG operation.

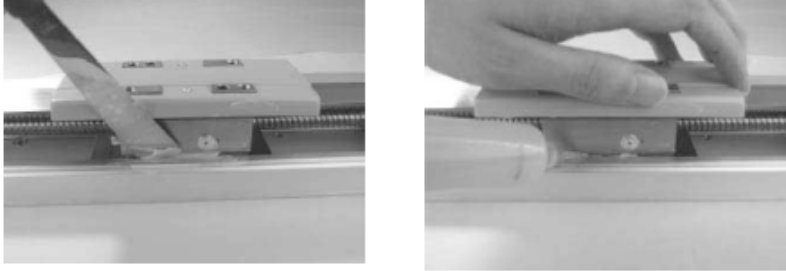

⚠ Caution: Supplying too much grease may increase sliding resistance and load to the motor, resulting in a drop of performance.

- 6) After grease supply is finished on one side, put back the side cover.
 Hitting it on the edge of the stainless steel sheet when attaching may cause the sheet damaged or meandered, which may result in earlier degradation or wear-out of the sheet.
 Therefore, to avoid a touch to the sheet edge, insert a shim (approx. 0.1 to 0.2mm) between the sheet and cover to put the sheet up when pushing in the cover.
 (Note) After the side covers are put back on, move the slider from right to left in the full stroke to check such things as looseness of the stainless steel sheet.
 [Refer to 4.7 Procedures for Replacement and Adjustment of Stainless Steel Sheet]

When attaching the side covers, tighten the screws with the tightening torque described below.

Type	Bolt Diameter	Tightening Torque
BA4/BA4U	M2.6 hex socket head cap screw	45.8N•cm
	M3 cross recessed pan head machine screw	41.4N•cm
BA6/BA6U BA7/BA7U	M3 hex socket head cap screw	83.0N•cm
	M3 cross recessed pan head machine screw	41.4N•cm

⚠ Caution:

- Pay attention not to have the stainless steel sheet bent forcefully or damaged when working.
 Also, there is a risk of getting hurt on the edge of the stainless steel sheet. Make sure to have a safety countermeasure such as wearing gloves while working on.
- In case the grease got into your eye, immediately go see the doctor to get appropriate care. After finishing the grease supply work, wash your hands carefully with water and soap to rinse the grease off.

4.7 Procedures for Replacement and Adjustment of Stainless Steel Sheet

Described below explains how to replace and adjust the stainless steel sheet.

Replacement of the stainless steel sheet can be conducted without detaching the side covers.

4.7.1 Preparation

(1) Required Items

- Replacement stainless steel sheet
- Phillips Screwdriver
- Adhesive tape

(2) Stainless steel sheet tension

The degradation and consumption of the stainless steel sheet is influenced by how it is tensed. If the stainless steel sheet is tensed with high force and the clearance to the slider is too big, it may cause breakage with fatigue.

On the other hand, if the tension is too loose, the stainless steel sheet may interfere with the back face of the slider cover, which may cause dust generation.

(3) Names of the Parts

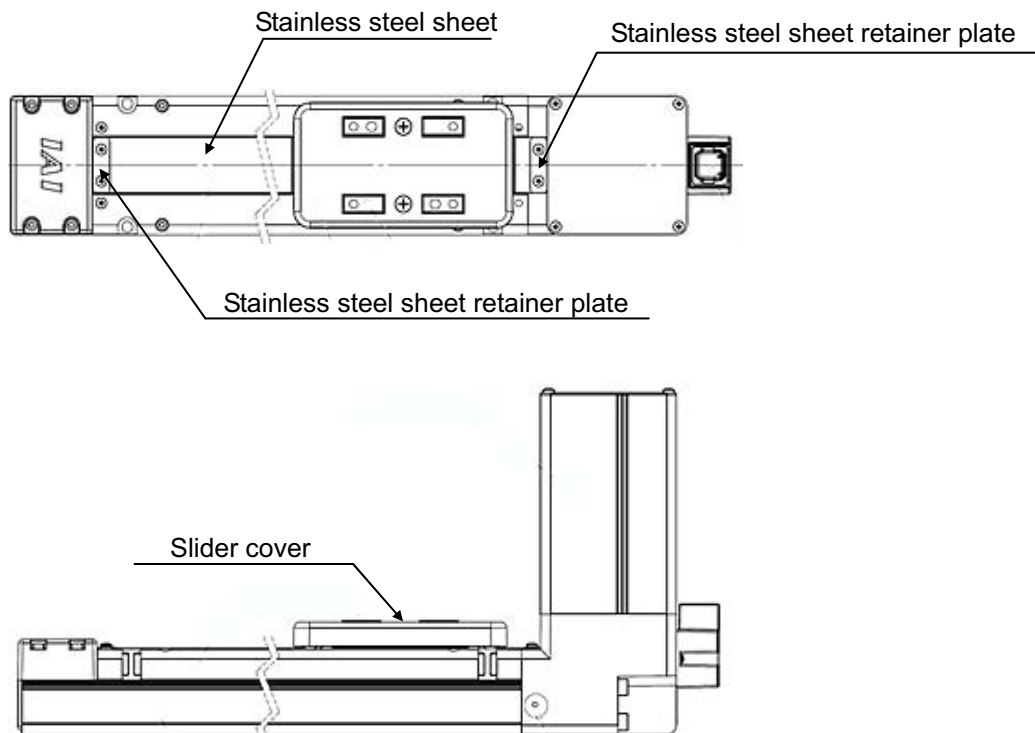

4.7.2 Procedure for Replacement and Tuning

- 1) Remove the screws (4 places) holding the stainless steel sheet and stainless steel sheet retainer plates (2 pieces) with using a Phillips screwdriver.
- 2) Pull the old stainless steel sheet

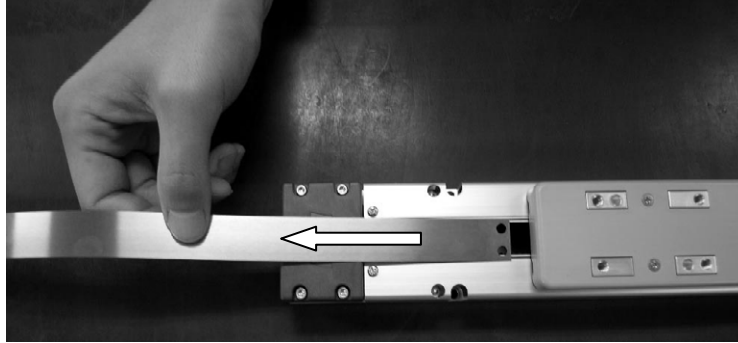

- 3) Adhere cellophane tape on one end of the new stainless steel sheet.

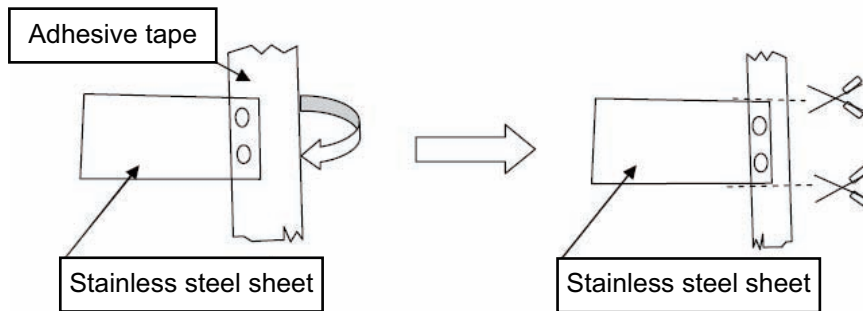

Fold the tape over to cover up the edge of the stainless steel sheet. At this time, have approximately 3mm of overhang from the stainless steel sheet. Cut the tape on the excess parts.

- 4) Put the stainless steel sheet with an adhesive tape on the side cover.

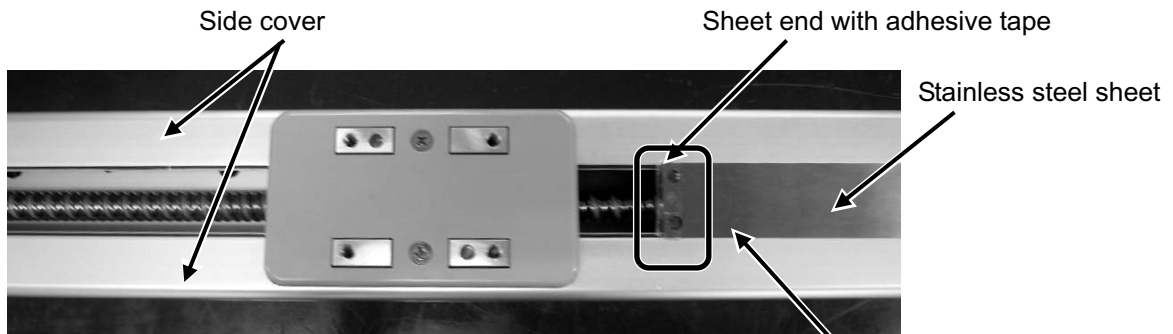

Pay attention not to drop the stainless steel sheet in the hole.

- 5) With the stainless steel sheet being held, move the slider to put through the stainless steel sheet..

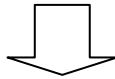
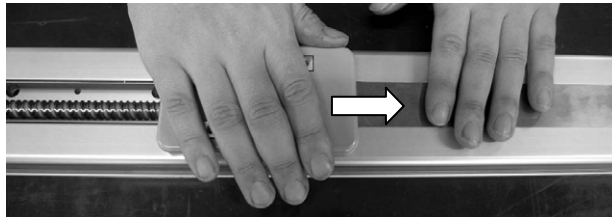
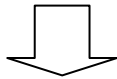
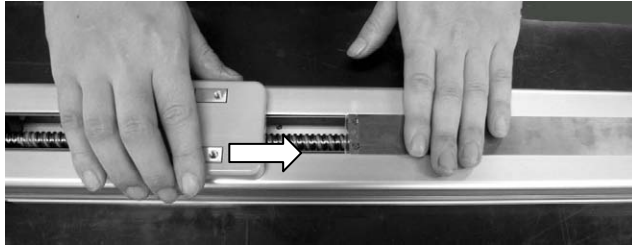

- 6) After the stainless steel sheet passes through the slider, pull one end of the stainless steel sheet out to the position of the stainless steel retainer plate. Take off the adhesive tape once positioning is finished.

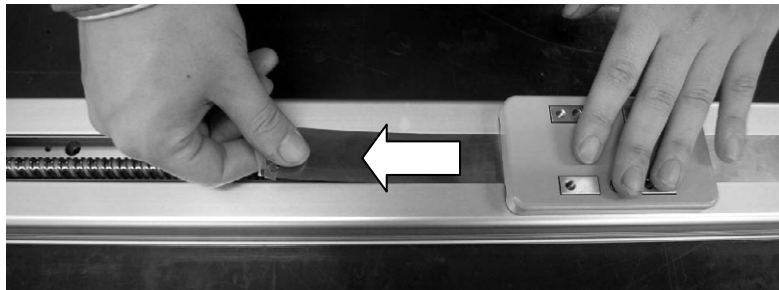

- 7) Affix the two stainless steel sheet retainer plates with screws (4 places).
To affix them, use a Phillips driver.



There are two slits on the body as a guide for stainless steel attachment. Allocate the stainless steel sheet so it comes in the center between two slits. Attach the stainless steel sheet without any looseness.

Tightening Torque
41.4N•cm

- 8) After fixing the stainless steel sheet retainer plates, move the slider manually in the full-stroke range to confirm that there is no looseness or flexure on the stainless steel sheet. Redo the process from Step 7) in case of any problem.

 **Caution:** • Pay attention not to have the stainless steel sheet bent forcefully or damaged when working.
Also, there is a risk of getting hurt on the edge of the stainless sheet. Make sure to have a safety countermeasure such as wearing gloves while working on.

4.8 Procedure for Belt Replacement and Tuning

4.8.1 Tension Adjustment

[Required Items]

- Tension adjustment wire (provide a commercially available wire like the one shown in the photograph at right)

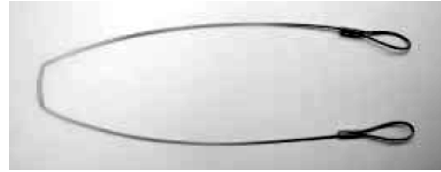

- Hex wrench

BA4/BA4U	Opposite side 2.5mm, Opposite side 3 mm
BA6/BA6U, BA7/BA7U	Opposite side 3mm, Opposite side 4 mm

- Tension gauge (with capacity of 18kgf of tension or more)

[Procedures]

- 1) Remove the screws (2 places in circles) holding the stainless steel sheet and stainless steel sheet retainer plates with using a Phillips screwdriver.

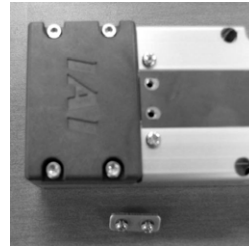
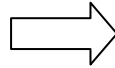
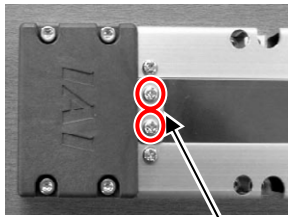

Stainless steel sheet retainer plate

- 2) Remove the four M2.6 (for BA4/BA4U) or M3 (for BA6/BA6U, BA7/BA7U) screws holding the pulley cover with a hex wrench to detach the pulley cover.

Pulley cover

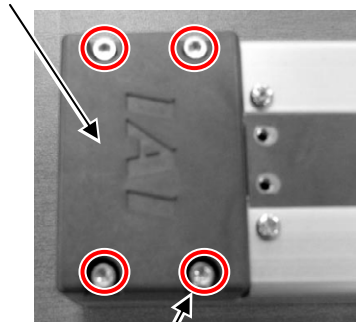

Screws

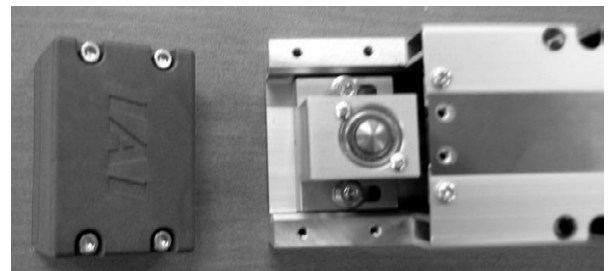
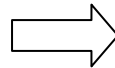

- 3) Loosen the M3 (for BA4/BA4U) or M3 (for BA6/BA6U, BA7/BA7U) hex socket flange head cap screw holding the pulley unit.

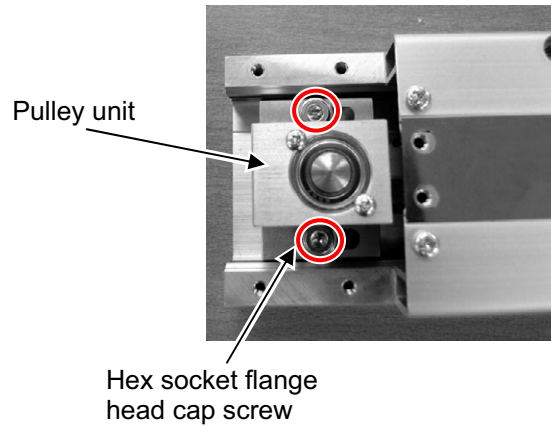

- 4) Adjust the belt tension.
 Hang a wire on the pulley unit and pull it evenly by applying tension described in the table below with a tension gauge.
 After reached the specified load, tighten the hex socket flange head cap screw with a 2.5mm-sized (for BA4/BA4U) or 3mm-sized (for BA6/BA6U, BA7/BA7U) hex wrench to hold the pulley unit.

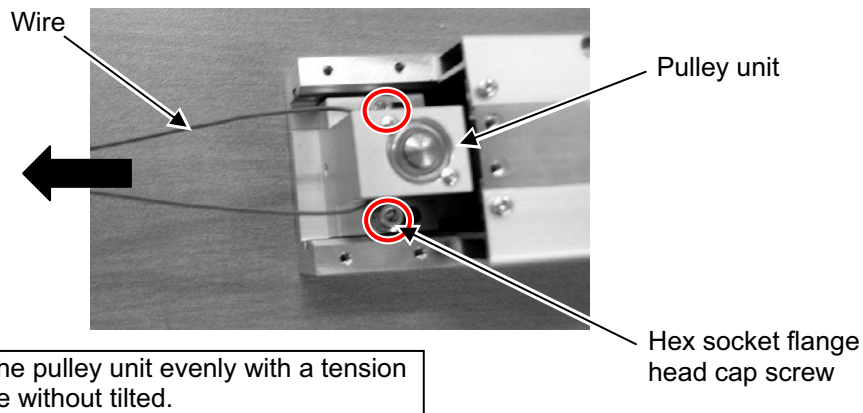

Type	Tension
	For belt tensile strength adjustment
BA4/BA4U	58N (5.92kgf)
BA6/BA6U	88N (8.98kgf)
BA7/BA7U	88N (8.98kgf)

- 5) Attach the pulley cover and tighten the four M2.6 (for BA4/BA4U) or M3 (for BA6/BA6U, BA7/BA7U) screws.

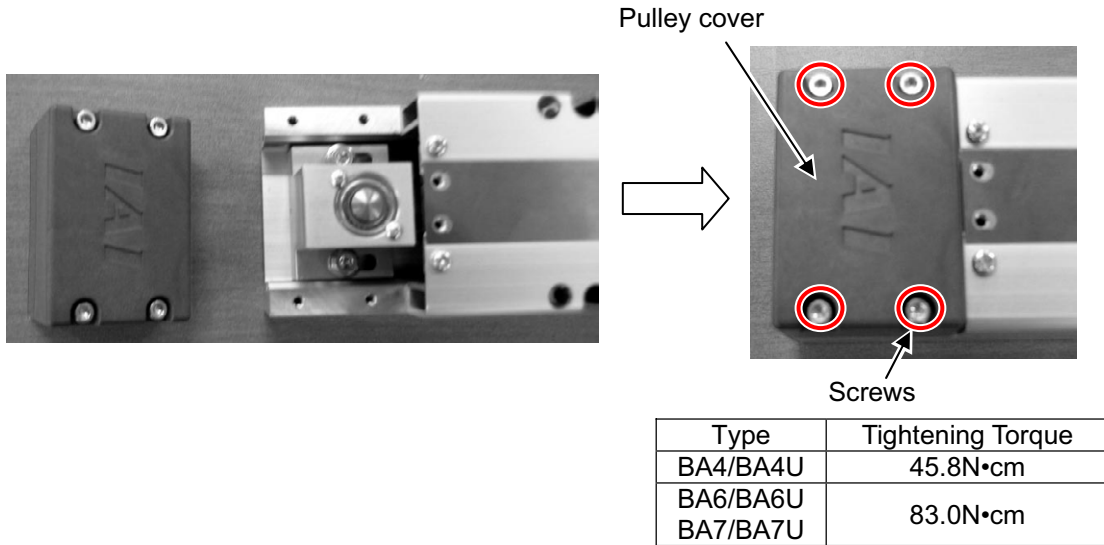

- 6) Affix the stainless steel sheet retaining plate with screws (2 places in circles) with using a Philips screwdriver.

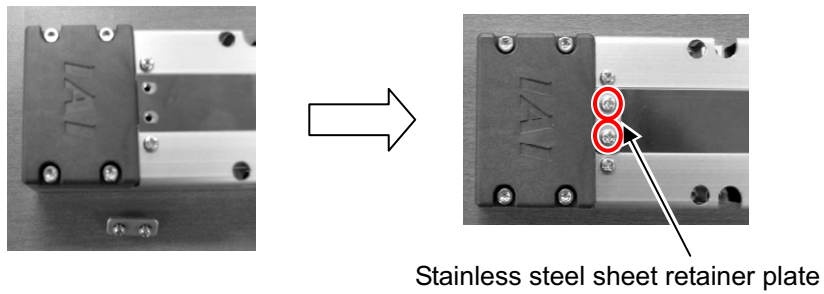

4.8.2 Replacement of the Belt

[Required Items]

- Belt for replacement

Model	IAI Maintenance Part Code	Manufacturer Model Code	
BA4/BA4U	LB-RCP5-BA4- (Stroke)	3GT width 6	GATES UNITTA ASIA
BA6/BA6U	LB-RCP5-BA6- (Stroke)	3GT width 9	
BA7/BA7U	LB-RCP5-BA7- (Stroke)		

- Tension adjustment wire
(provide a commercially available wire like the one shown in the photograph at right)
- Hex wrench

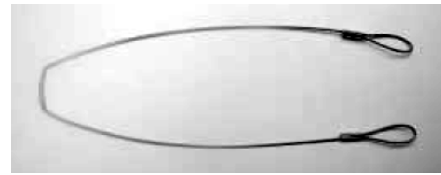

BA4/BA4U	Opposite side 2.5mm, Opposite side 3mm
BA6/BA6U, BA7/BA7U	Opposite side 3mm, Opposite side 4mm

- Tension gauge (with capacity of 9kgf of tension or more)

[Procedures]

- 1) Remove the two attachment screws holding the slider cover with using a Philips screwdriver, and detach the slider cover.

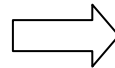
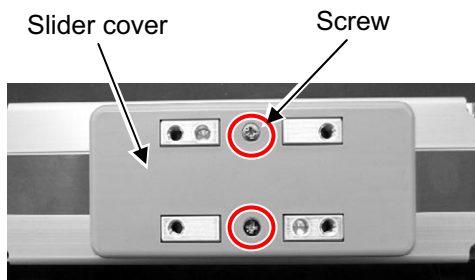

- 2) Remove the four attachment screws (4 places in circles) holding the stainless steel sheet, and detach the stainless steel sheet and stainless steel retaining plate.

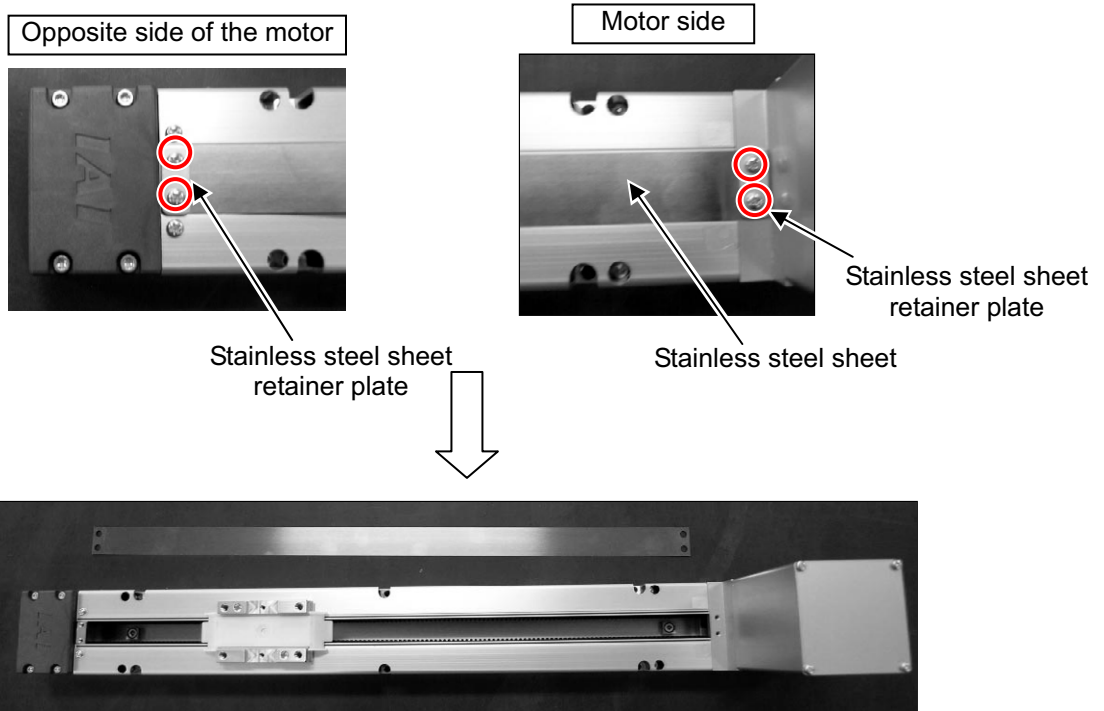

 **Caution:** • Pay attention not to have the stainless steel sheet bent forcefully or damaged when working.
Also, there is a risk of getting hurt on the edge of the stainless sheet. Make sure to have a safety countermeasure such as wearing gloves while working on.

- 3) Remove the side cover attachment screws (at arrows) to detach the side covers on the both ends. Screw size: M2.5, M3 (BA4/BA4U), M3 (BA6/BA6U, BA7/BA7U)
Do not remove the one in red circle.
Detach the side covers with the sheet plate remained on.
For some stroke patterns, there is another attachment screw on the side cover between two screws on right and left ends.
Make sure to remove them all.

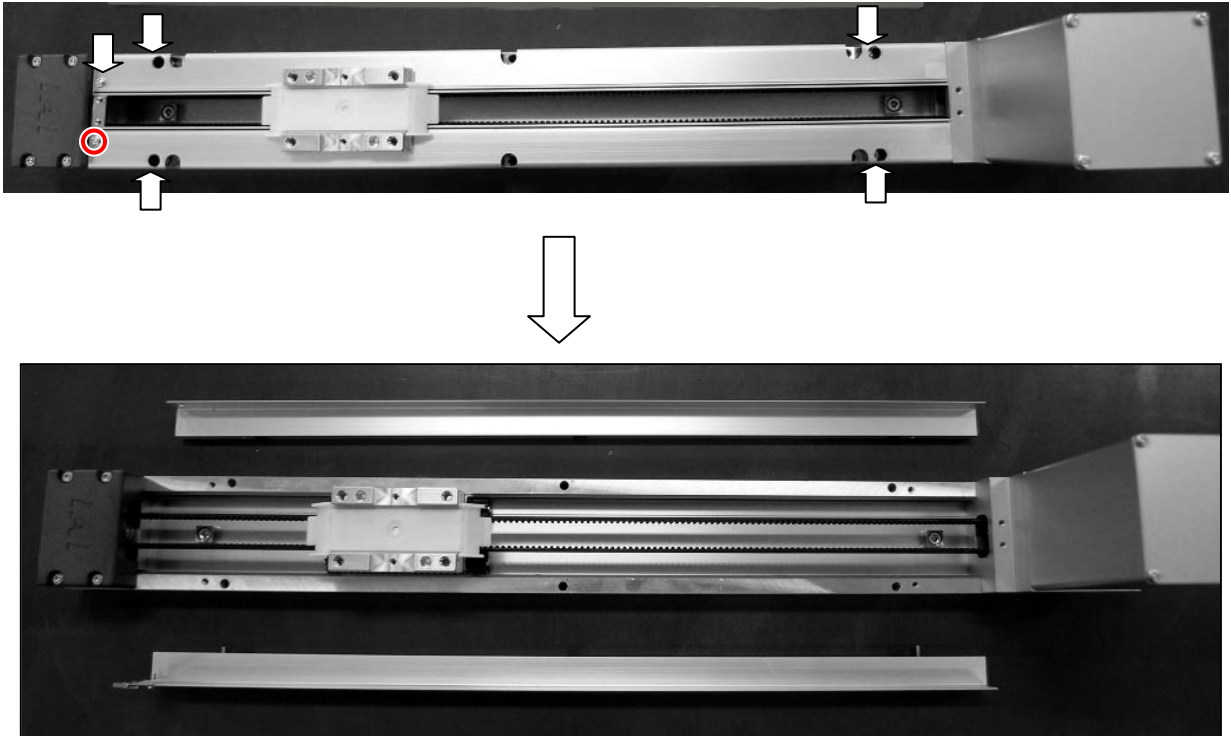

- 4) Remove the four M2.6 (for BA4/BA4U) or M3 (for BA6/BA6U, BA7/BA7U) screws holding the pulley cover with a hex wrench to detach the pulley cover.

Pulley cover

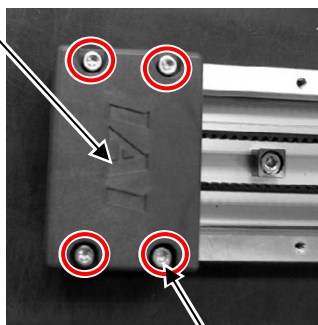

Screws

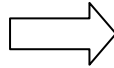

- 5) Remove the M3 (for BA4/BA4U) or M4 (for BA6/BA6U, BA7/BA7U) hex socket flange head cap screws holding the pulley unit to detach the pulley unit.

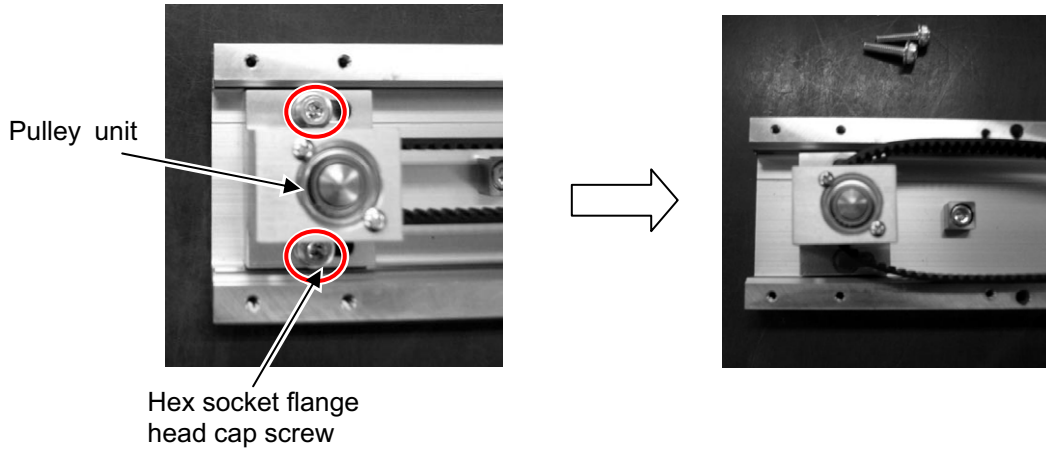

- 6) Remove the M3 screw holding the belt under the slider with using a hex wrench. Slide away the belt and the belt retainer appears. Detach the belt and belt retainer.

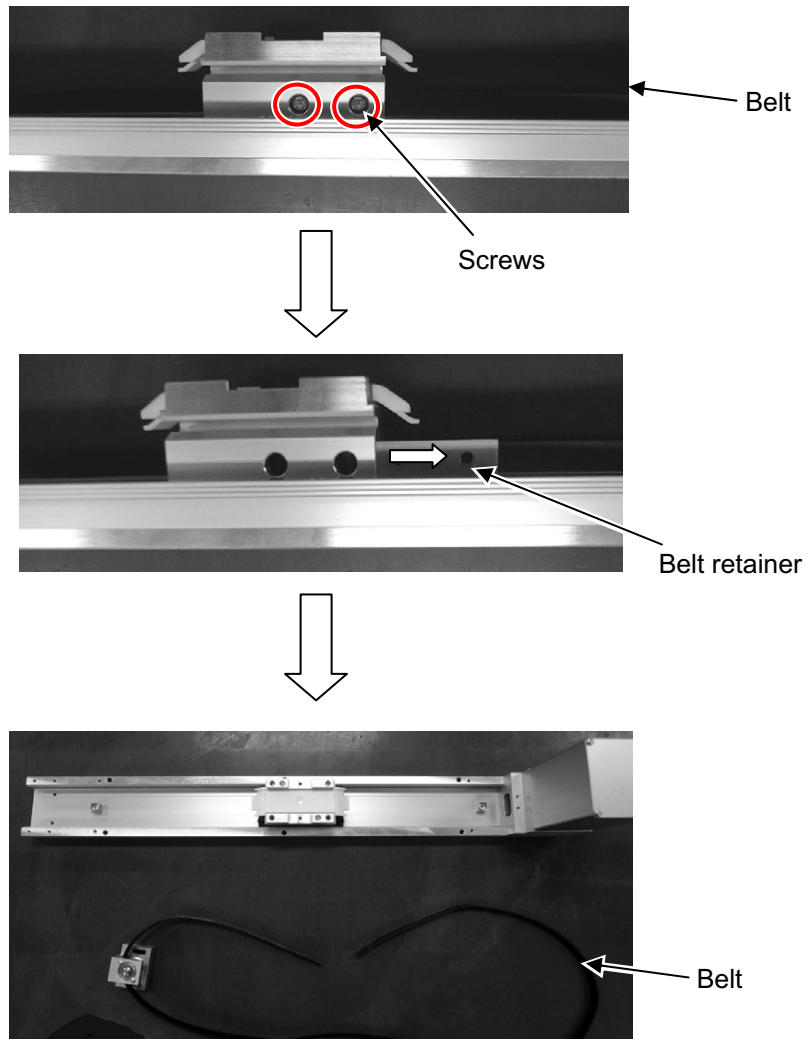

- 7) Attach the replacement belt through the slider, pulley (motor end) and pulley (tip end).
 (Note) Make sure the belt is not twisted.
 Next, put the both ends of the belt and the belt retainer through the hole on the slider and affix them with M3 screws.
 (Note) Make sure the rolled bushings are seated on the slider and the belt retainer.
 (Note) Make sure the belt is not pinched in between the rolled bushing and slider, and in between rolled bushing and belt retainer.

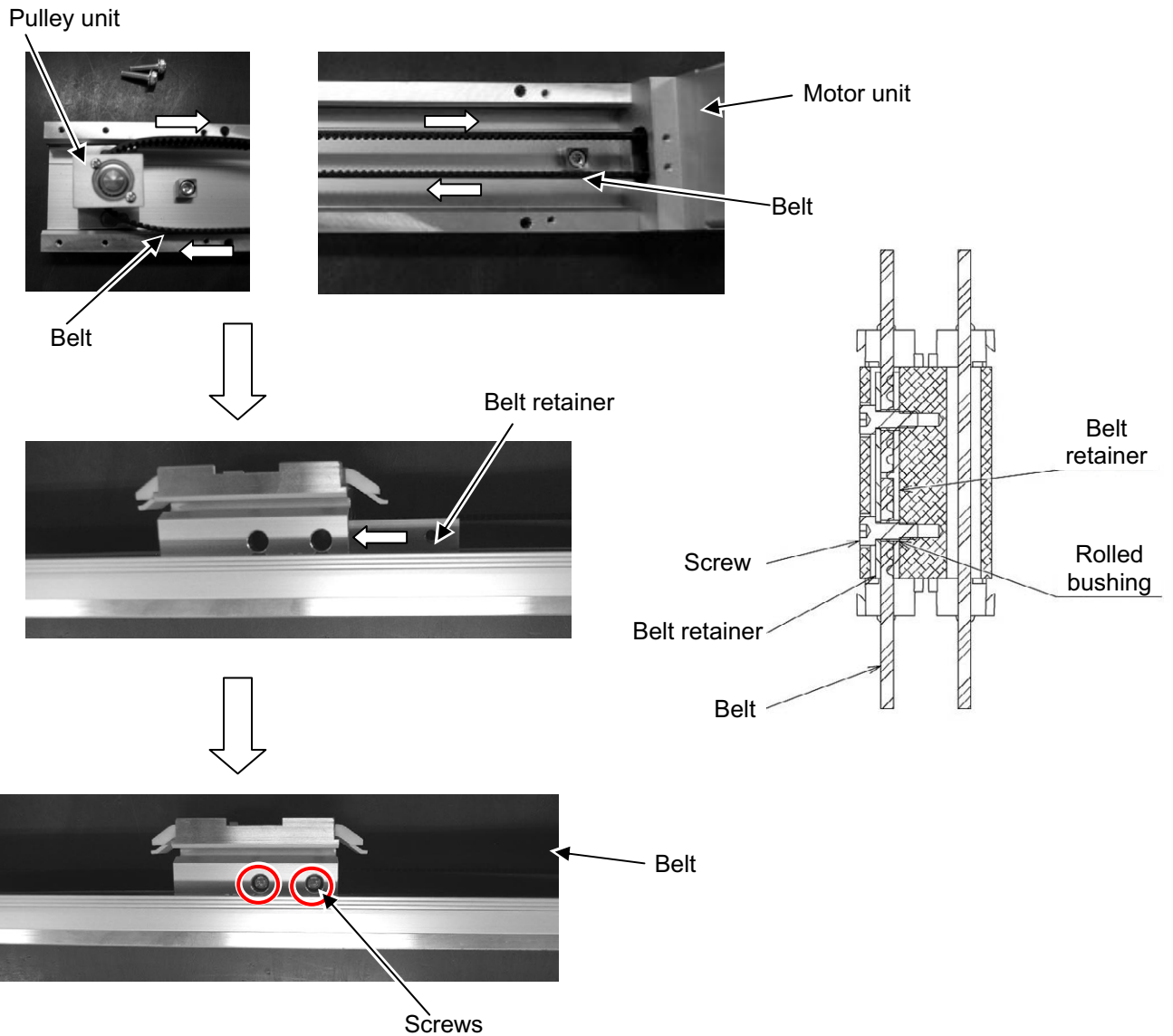

Tightening Torque
157N•cm

- 8) Loosely tighten the M3 (for BA4/BA4U) or M4 (for BA6/BA6U, BA7/BA7U) hex socket flange head cap screws holding the pulley unit for temporary to attach the pulley unit.

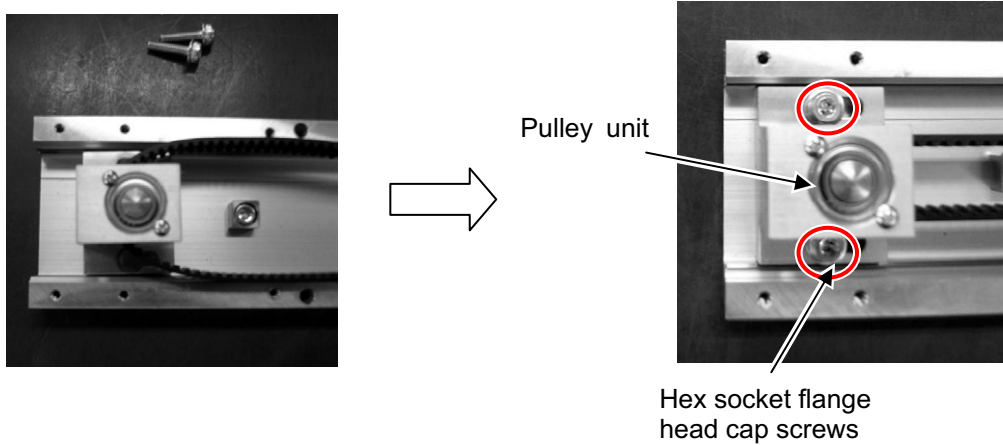

- 9) Adjust the belt tension.
 Hang a wire on the pulley unit and pull it evenly by applying tension described in the table below with a tension gauge.
 After reached the specified load, tighten the hex socket flange head cap screw with a 2.5mm-sized (for BA4/BA4U) or 3mm-sized (for BA6/BA6U, BA7/BA7U) hex wrench to hold the pulley unit.

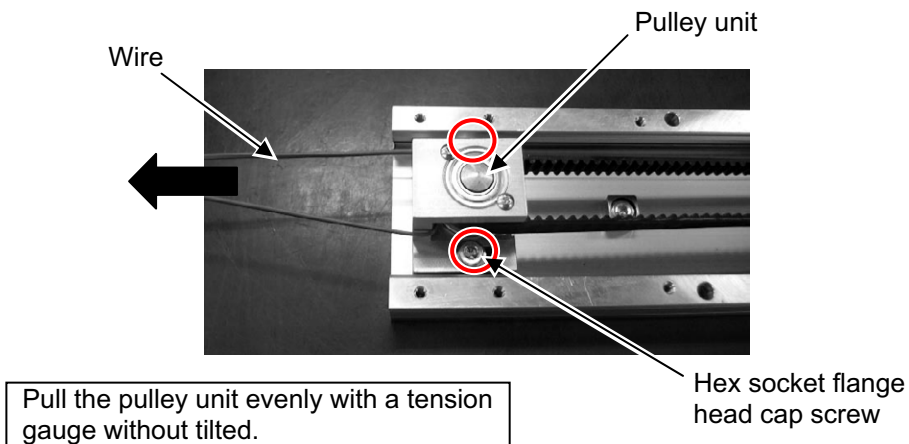

Type	Tension
	When replacing with new belt
BA4/BA4U	58N (5.92kgf)
BA6/BA6U	176N (17.96kgf)
BA7/BA7U	176N (17.96kgf)

- 10) Attach the pulley cover, tighten up with the four M2.6 (for BA4/BA4U) or M3 (for BA6/BA6U, BA7/BA7U) screws with using a hex wrench.

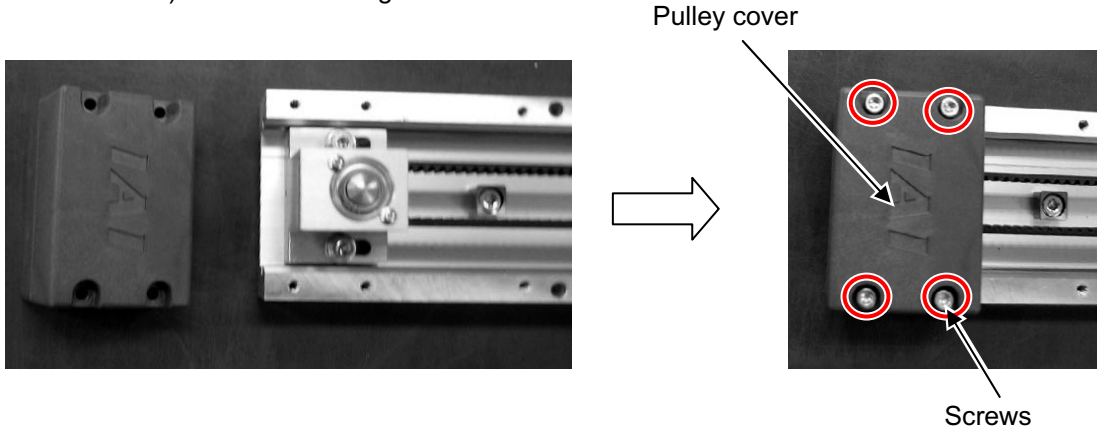

Type	Tightening Torque
BA4/BA4U	45.8N•cm
BA6/BA6U BA7/BA7U	83.0N•cm

- 11) Put on the side covers on the both sides, and tighten the attachment screws (at arrows) for the side covers.

Screw size: M2.5, M3 (BA4/BA4U), M3 (BA6/BA6U, BA7/BA7U)

For some stroke patterns, there is another attachment screw on the side cover between two screws on right and left ends.

Make sure to remove them all.



Type	Bolt Diameter	Tightening Torque
BA4/BA4U	M2.6 hex socket head cap screw	45.8N•cm
	M3 cross recessed pan head machine screw	41.4N•cm
BA6/BA6U BA7/BA7U	M3 hex socket head cap screw	83.0N•cm
	M3 cross recessed pan head machine screw	41.4N•cm

- 12) Put on the stainless steel sheet and stainless steel sheet retaining plate, and tighten the four M3 attachment screws (4 places in circles).

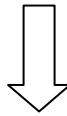
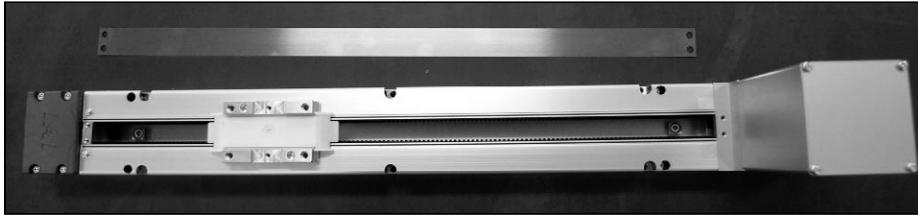

Opposite side of the motor

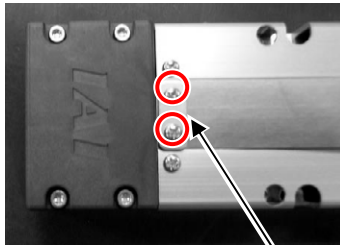

Stainless steel sheet retaining plate

Motor side

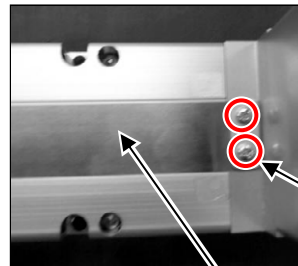

Stainless steel sheet retaining plate

Stainless steel sheet



There are two slits on the body as a guide for stainless steel attachment. Allocate the stainless steel sheet so it comes in the center between two slits. Attach the stainless steel sheet without any looseness.

Tightening Torque

41.4N·cm

⚠ Caution: • Pay attention not to have the stainless steel sheet bent forcefully or damaged when working.
Also, there is a risk of getting hurt on the edge of the stainless sheet. Make sure to have a safety countermeasure such as wearing gloves while working on.

- 13) Put on the slider cover, and tighten the two attachment screws with using a Philips screwdriver.

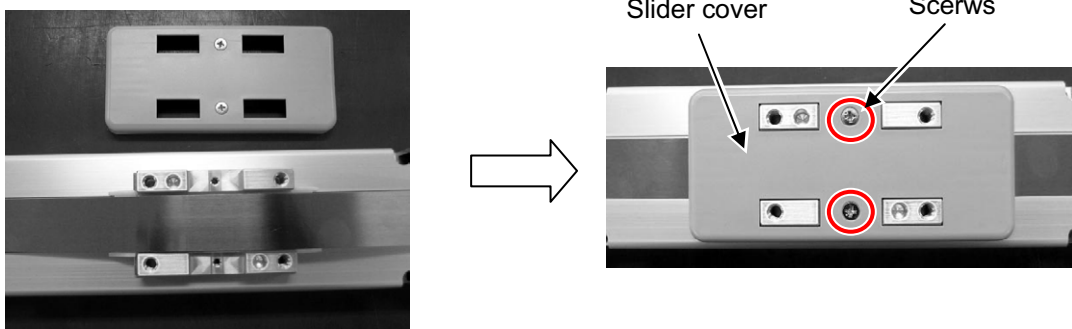

Type	Bolt Diameter	Tightening Torque
BA4/BA4U	M2.6 cross recessed flat-head machine screw	43.1N•cm
BA6/BA6U	M3 cross recessed flat-head machine screw	76.8N•cm
BA7/BA7U	M4 cross recessed flat-head machine screw	179N•cm

- 14) Move the slider manually in the full-stroke range to confirm that there is no looseness or flexure on the stainless steel sheet. If any trouble, redo attaching the stainless steel sheet.

4.9 Replacement Process

[Required Items]

Motor Unit for Replacement

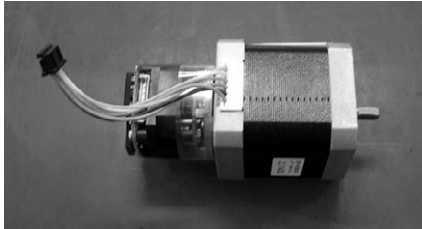

W/O Brake

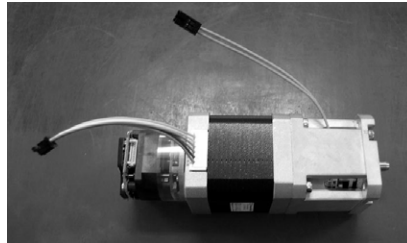

With Brake

- Tension adjustment wire (provide a commercially available wire like the one shown in the photograph at right)
- Hex wrench

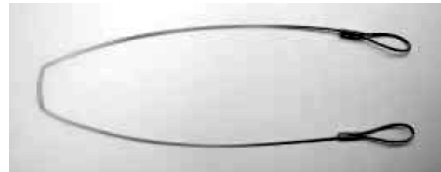

BA4/BA4U	opposite side 2.5mm, opposite side 3mm
BA6/BA6U BA7/BA7U	opposite side 3mm, opposite side 4mm

- Tension gauge (with capacity of 9kgf of tension or more)

[Procedures]

- 1) Remove the two attachment screws holding the slider cover with using a Philips screwdriver, and detach the slider cover.

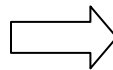
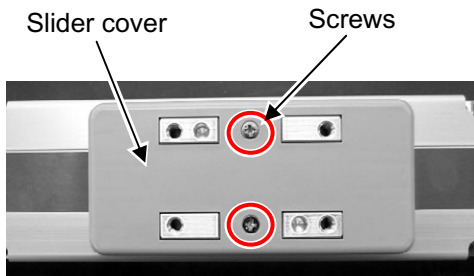

- 2) Remove the four attachment screws (4 places in circles) holding the stainless steel sheet, and detach the stainless steel sheet and sheet retaining plate.

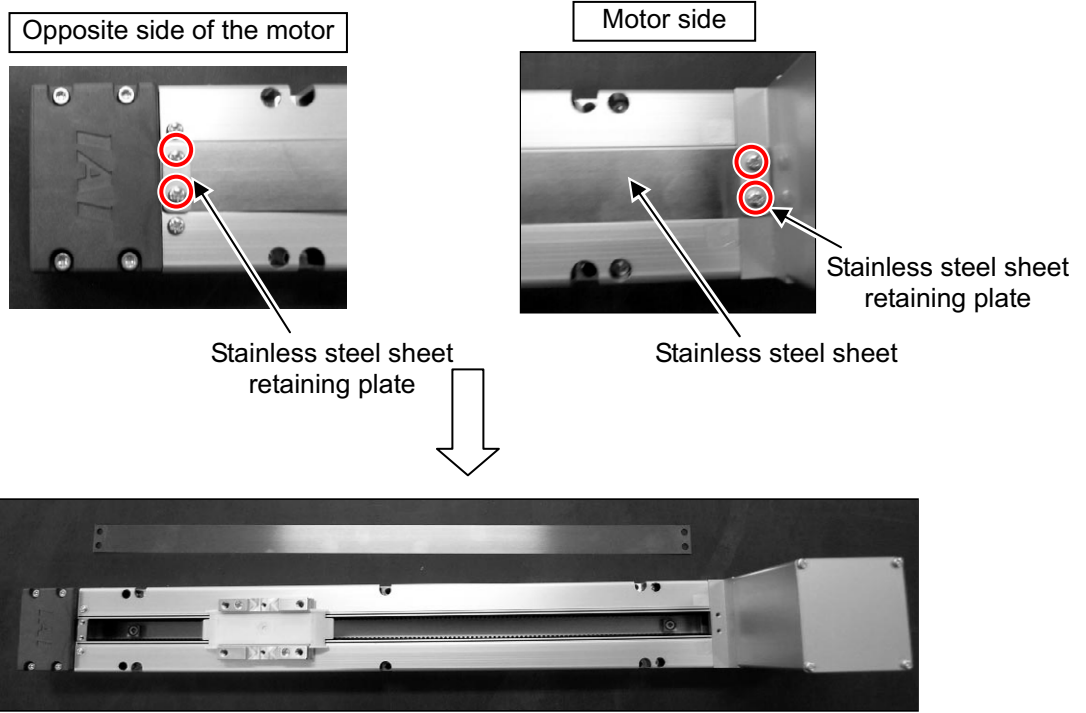

⚠ Caution: • Pay attention not to have the stainless steel sheet bent forcefully or damaged when working.
Also, there is a risk of getting hurt on the edge of the stainless sheet. Make sure to have a safety countermeasure such as wearing gloves while working on.

- 3) Remove the side cover attachment screws (at arrows) to detach the side covers on the both ends. Screw size: M2.5, M3 (BA4/BA4U), M3 (BA6/BA6U, BA7/BA7U)
Do not remove the one in red circle.
Detach the side covers with the sheet plate remained on.
For some stroke patterns, there is another attachment screw on the side cover between two screws on right and left ends.
Make sure to remove them all.

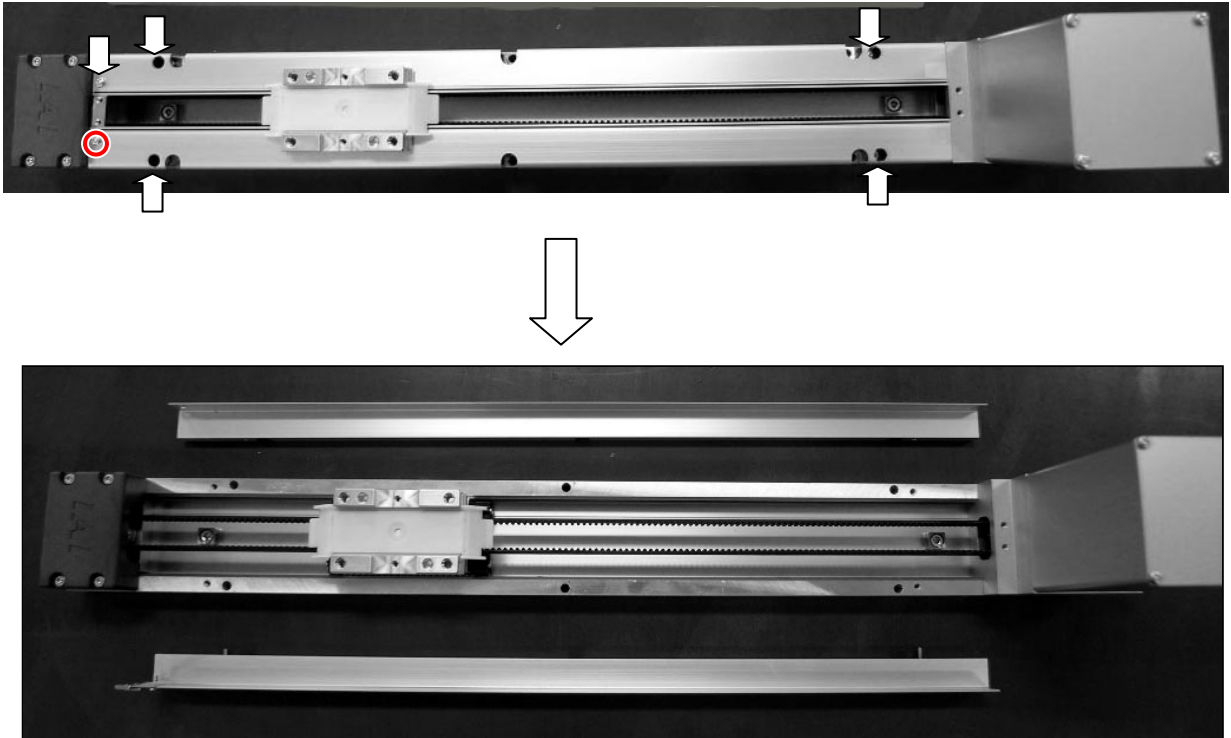

- 4) Remove the four M2.6 (for BA4/BA4U) or M3 (for BA6/BA6U, BA7/BA7U) screws holding the pulley cover with a hex wrench to detach the pulley cover.

Pulley cover

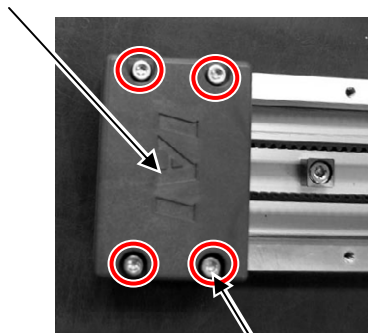

Screws

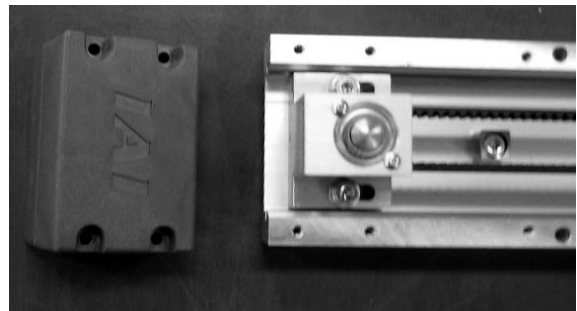
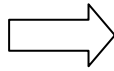

- 5) Remove the M3 (for BA4/BA4U) or M4 (for BA6/BA6U, BA7/BA7U) hex socket flange head cap screws holding the pulley unit to detach the pulley unit.

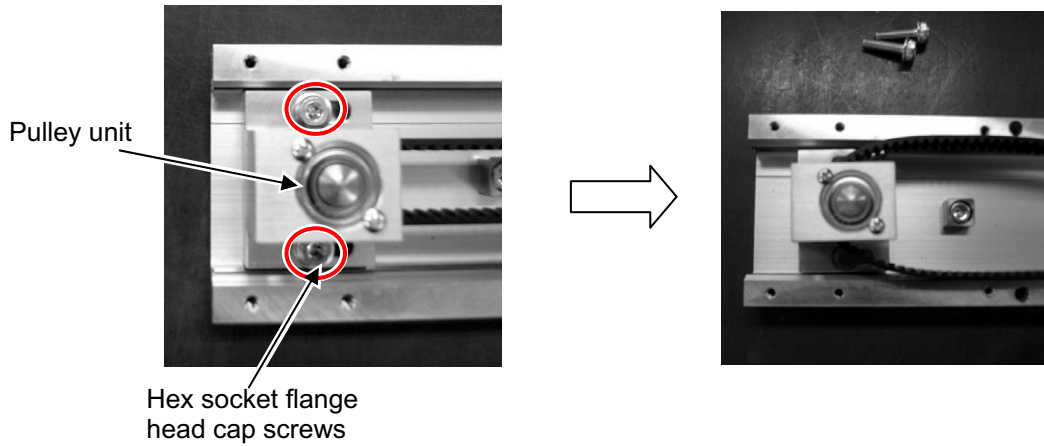

- 6) Remove the M3 screw holding the belt under the slider with using a hex wrench. Slide away the belt and the belt retainer appears. Detach the belt and belt retainer.

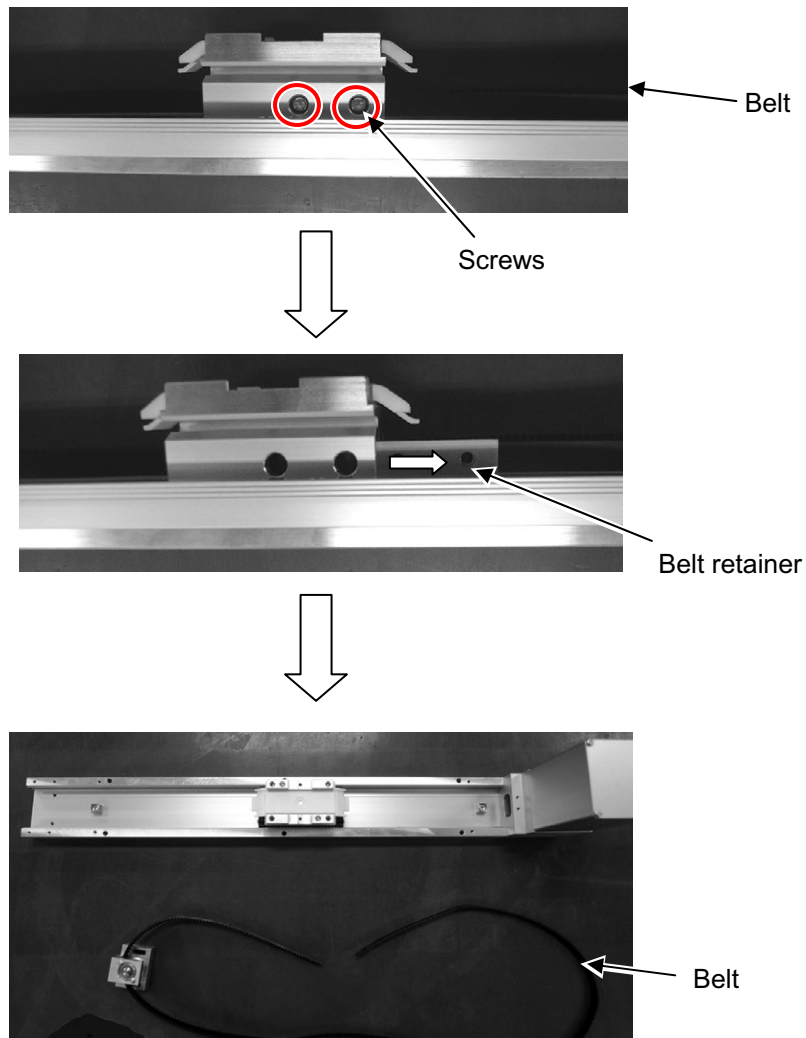

- 7) Remove the four attachment screws holding the motor cover and end cover with using a Philips screwdriver to detach the motor cover and end cover.

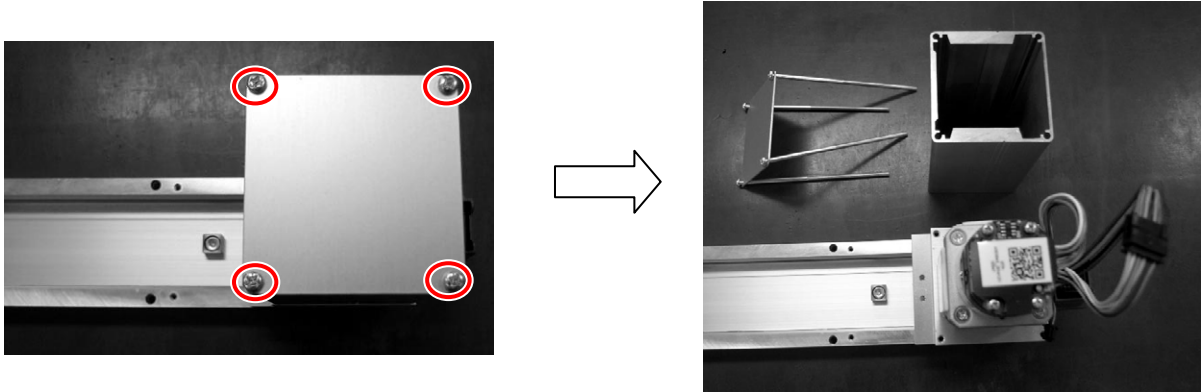

- 8) Pull off the motor and encoder connector.

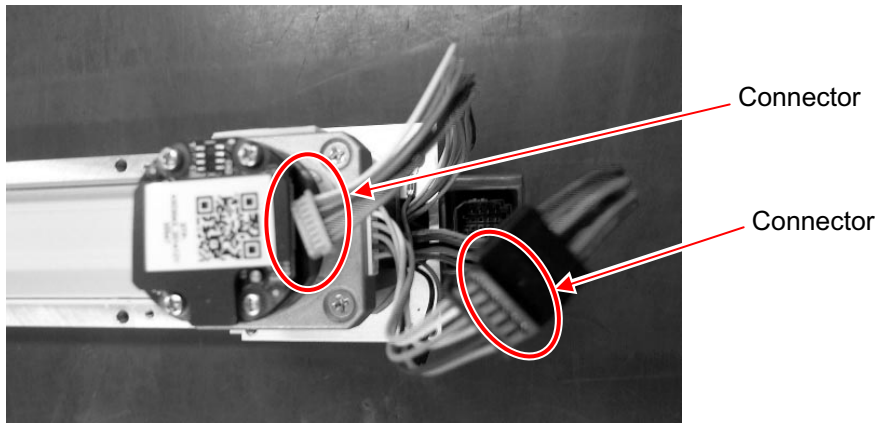

- 9) For BA7/BA7U, the motor can be taken off in the condition that the motor cover is detached. For BA4/BA4U and BA6/BA6U, turn around the actuator if it is a type with the motor unit mounted on the top, remove the screws shown in the figure below (4 places in circles), and take off the motor. Remove the four screws of M3 (for BA4/BA4U and BA6/BA6U) or M4 (for BA7/BA7U) affixing the motor with using a hex wrench to take off the motor.

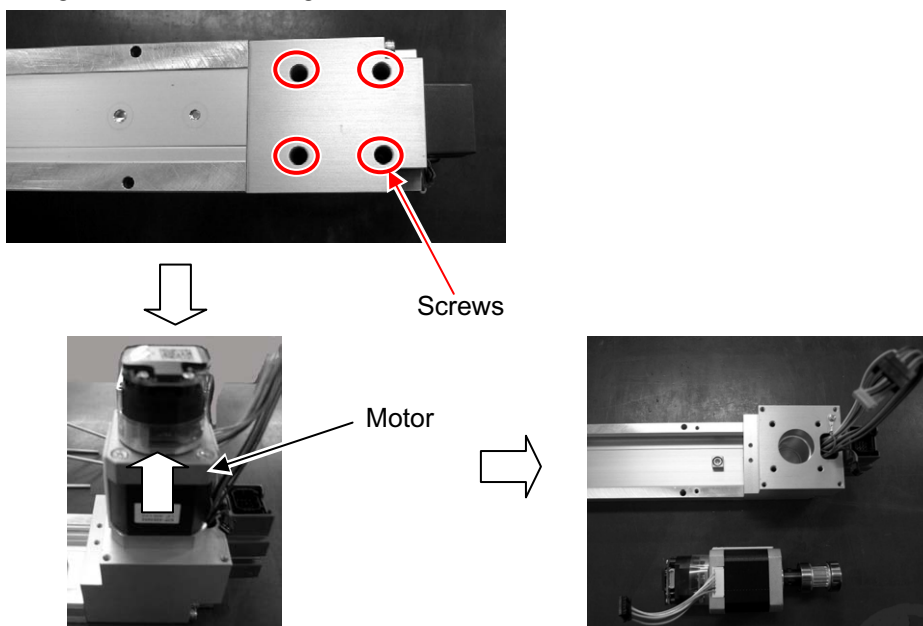

- 10) To reuse the pulley, remove the two M4 (BA4/BA4U, BA6/BA6U) or M5 (BA7/BA7U) hex socket set screws holding the pulley with using a hex wrench to detach the pulley.

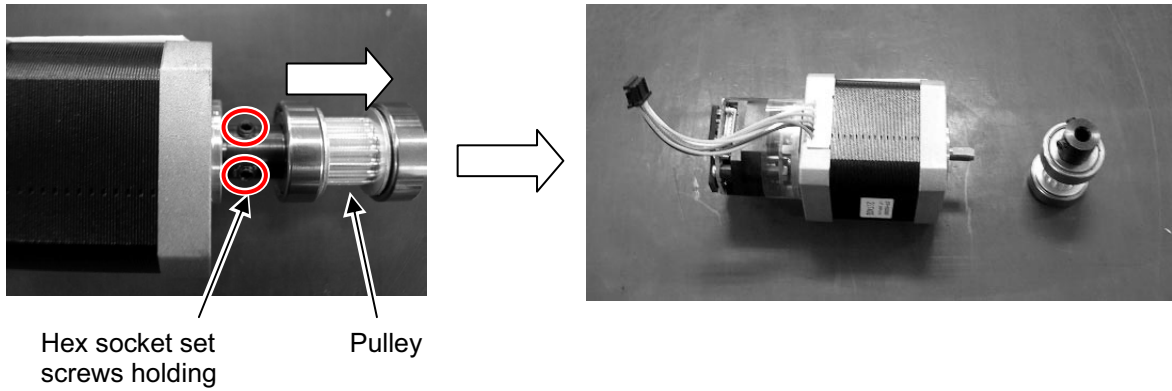

- 11) Attach the detached pulley to the replacement motor with keeping gap of Dimension G. Tighten the four M4 (BA4/BA4U, BA6/BA6U) or M5 (BA7/BA7U) hex socket set screws holding the pulley with using a hex wrench to affix the pulley.

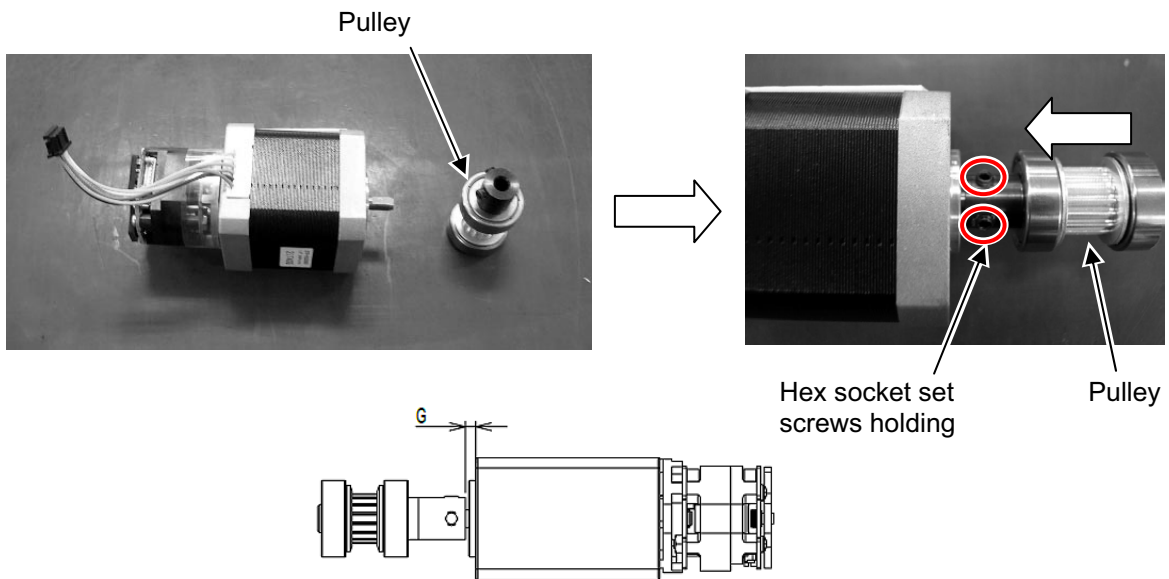

Type	G
BA4/BA4U BA6/BA6U	3
BA7/BA7U	2.5

Type	Tightening Torque
BA4/BA4U BA6/BA6U	167N•cm
BA7/BA7U	353N•cm

- 12) For BA4/BA4U and BA6/BA6U, attach the motor for replacement as shown in the figures below, and tighten the four screws of M3 (BA4/BA4U and BA6/BA6U) to hold the motor. For BA7/BA7U, tighten the motor from the top with four M4 screws.

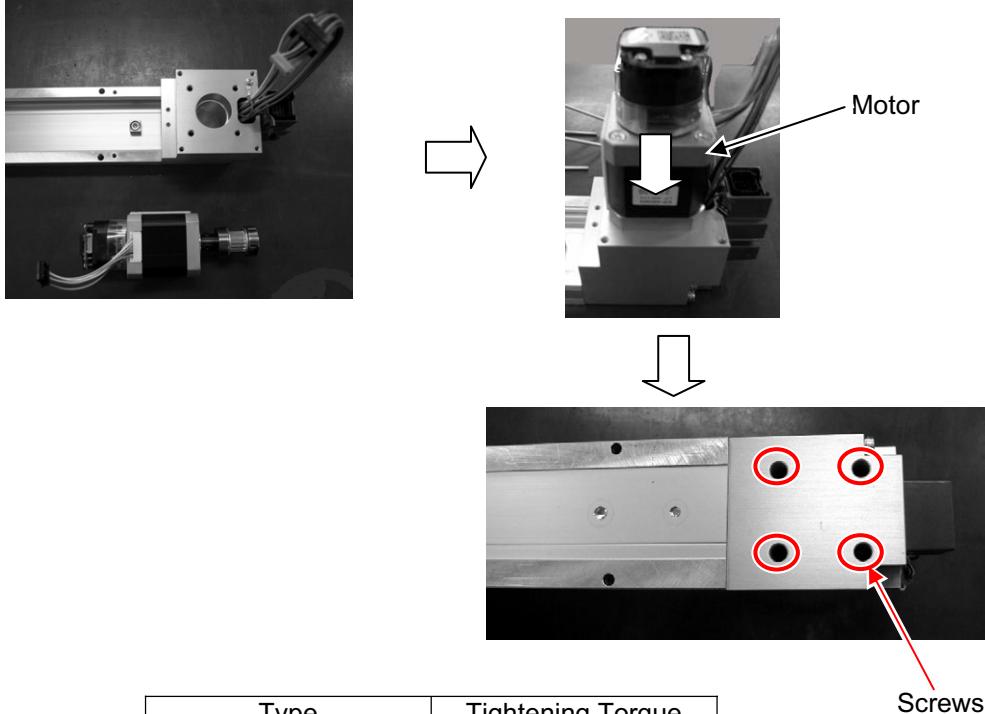

Type	Tightening Torque
BA4/BA4U BA6/BA6U	83N•cm
BA7/BA7U	176N•cm

- 13) Plug the motor/encoder connector to the motor.

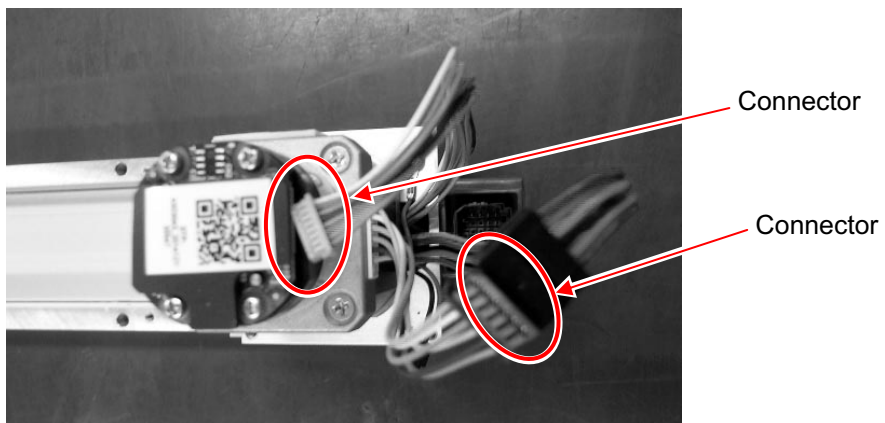

- 14) Put on the motor cover, and tighten the four attachment screws holding the motor cover and end cover with using a Philips screwdriver.

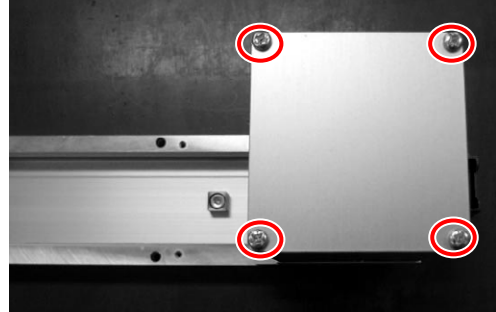
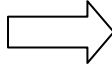
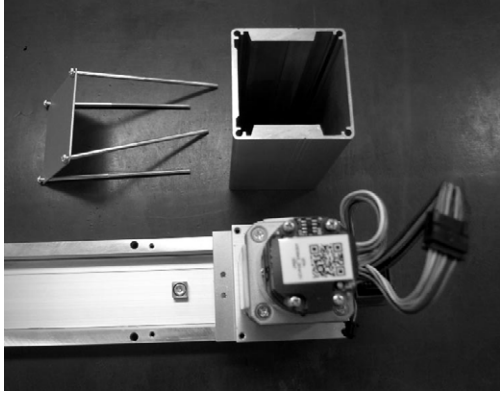

- 15) Attach the replacement belt through the slider, pulley (motor end) and pulley (tip end).
 (Note) Make sure the belt is not twisted.
 Next, put the both ends of the belt and the belt retainer through the hole on the slider and affix them with M3 screws.
 (Note) Make sure the rolled bushings are seated on the slider and the belt retainer.
 (Note) Make sure the belt is not pinched in between the rolled bushing and slider, and in between rolled bushing and belt retainer.

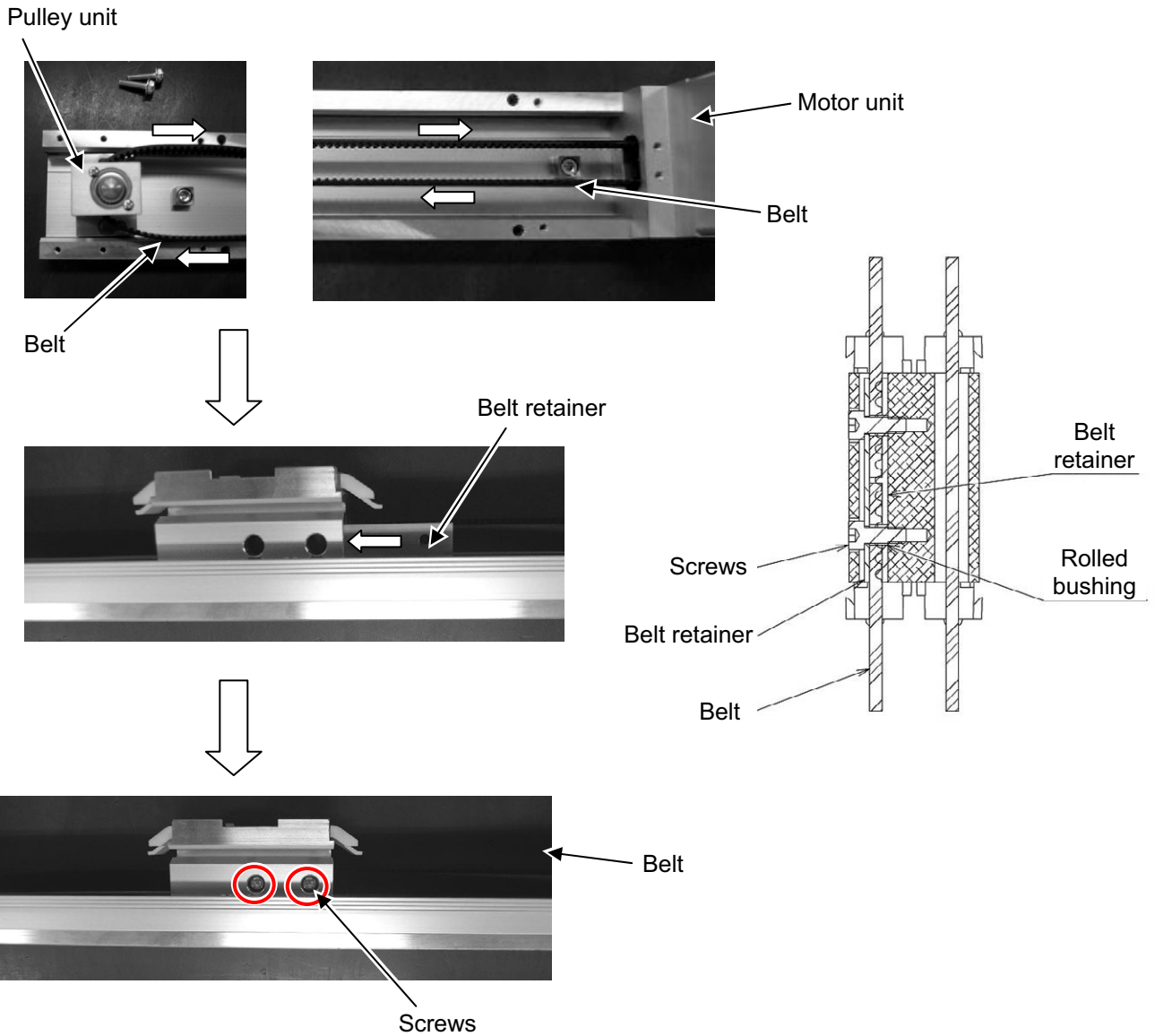

Tightening Torque
157N•cm

- 16) Loosely tighten the M3 (for BA4/BA4U) or M4 (for BA6/BA6U, BA7/BA7U) hex socket flange head cap screws holding the pulley unit for temporary to attach the pulley unit.

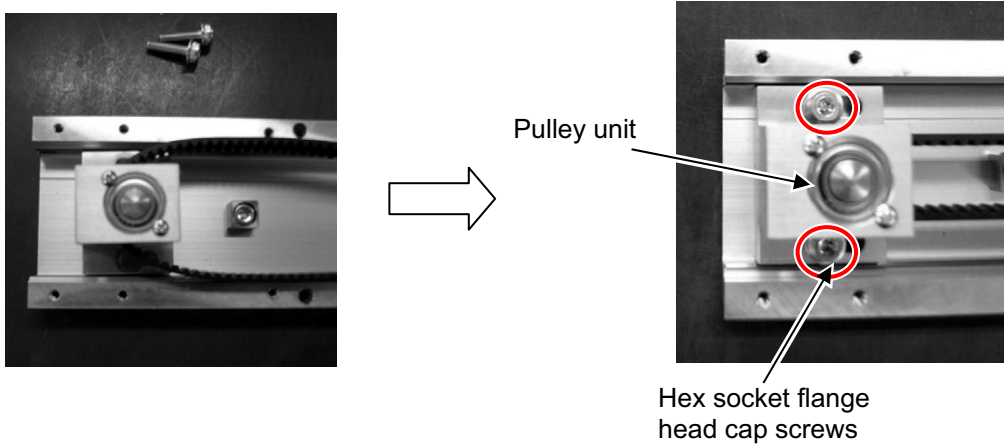

- 17) Adjust the belt tension.
 Hang a wire on the pulley unit and pull it evenly by applying tension described in the table below with a tension gauge.
 After reached the specified load, tighten the hex socket flange head cap screw with a 2.5mm-sized (for BA4/BA4U) or 3mm-sized (for BA6/BA6U, BA7/BA7U) hex wrench to hold the pulley unit.

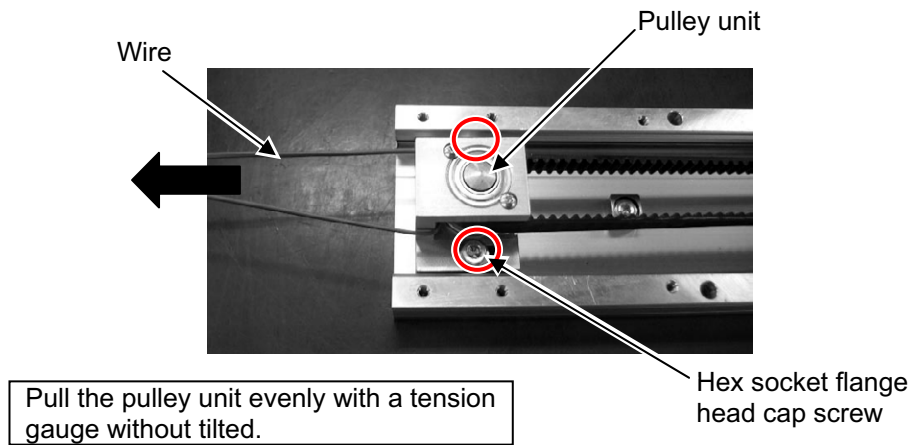

Type	Tension	
	When reusing existing belt	When replacing with new belt
BA4/BA4U	58N (5.92kgf)	58N (5.92kgf)
BA6/BA6U	88N (8.98kgf)	176N (17.96kgf)
BA7/BA7U	88N (8.98kgf)	176N (17.96kgf)

- 18) Attach the pulley cover and tighten the four M2.6 (for BA4/BA4U) or M3 (for BA6/BA6U, BA7/BA7U) screws.

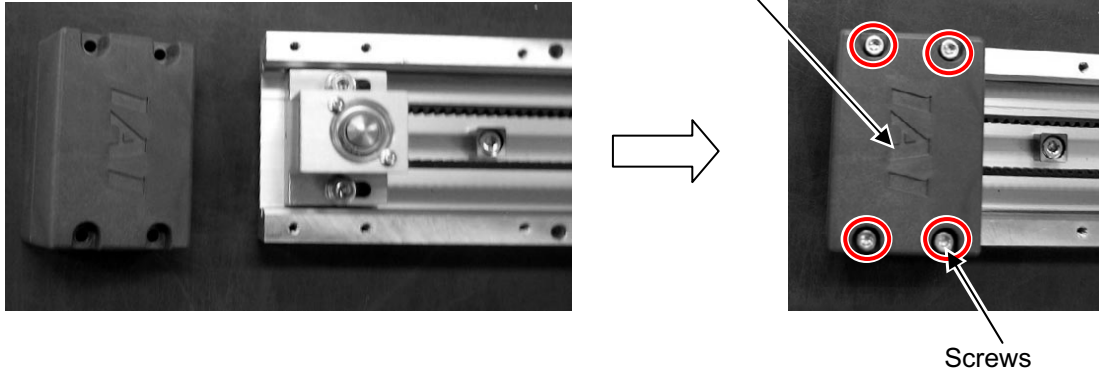

Type	Tightening Torque
BA4/BA4U	45.8N•cm
BA6/BA6U BA7/BA7U	83.0N•cm

- 19) Put on the side covers on the both sides, and tighten the attachment screws (at arrows) for the side covers.

Screw size: M2.5, M3 (BA4/BA4U), M3 (BA6/BA6U, BA7/BA7U)

For some stroke patterns, there is another attachment screw on the side cover between two screws on right and left ends.

Make sure to remove them all.



Type	Bolt Diameter	Tightening Torque
BA4/BA4U	M2.6 hex socket head cap screw	45.8N•cm
	M3 cross recessed pan head machine screw	41.4N•cm
BA6/BA6U BA7/BA7U	M3 hex socket head cap screw	83.0N•cm
	M3 cross recessed pan head machine screw	41.4N•cm

- 20) Put on the stainless steel sheet and stainless steel sheet retaining plate, and tighten the four M3 attachment screws (4 places in circles).

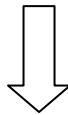
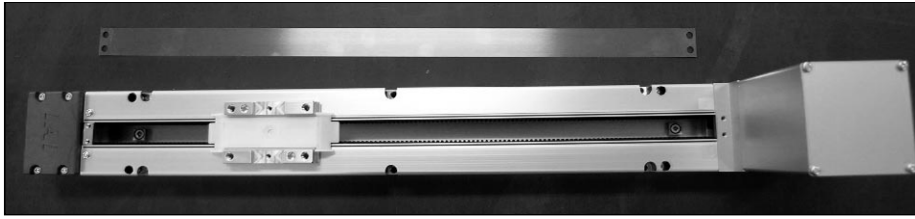

Opposite side of the motor

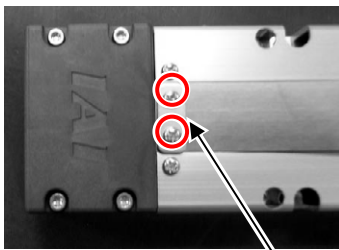

Stainless steel sheet retaining plate

Motor side

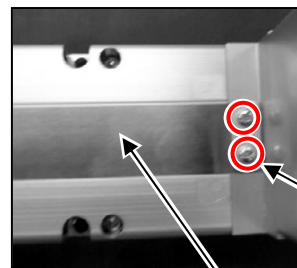

Stainless steel sheet retaining plate

Stainless steel sheet



There are two slits on the body as a guide for stainless steel attachment. Allocate the stainless steel sheet so it comes in the center between two slits. Attach the stainless steel sheet without any looseness.

Tightening Torque

41.4N•cm

⚠ Caution: • Pay attention not to have the stainless steel sheet bent forcefully or damaged when working.
Also, there is a risk of getting hurt on the edge of the stainless sheet. Make sure to have a safety countermeasure such as wearing gloves while working on.

21) Put on the slider cover, and tighten the two attachment screws with using a Philips screwdriver.

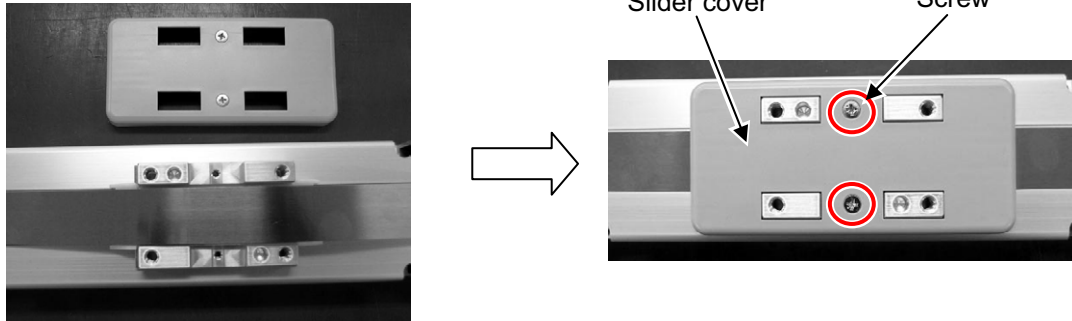

Type	Bolt Diameter	Tightening Torque
BA4/BA4U	M2.6 cross recessed flat-head machine screw	43.1N•cm
BA6/BA6U	M3 cross recessed flat-head machine screw	76.8N•cm
BA7/BA7U	M4 cross recessed flat-head machine screw	179N•cm

22) Move the slider manually in the full-stroke range to confirm that there is no looseness or flexure on the stainless steel sheet. If any trouble, redo attaching the stainless steel sheet.

5. External Dimensions

5.1 RCP5-BA4/BA4U

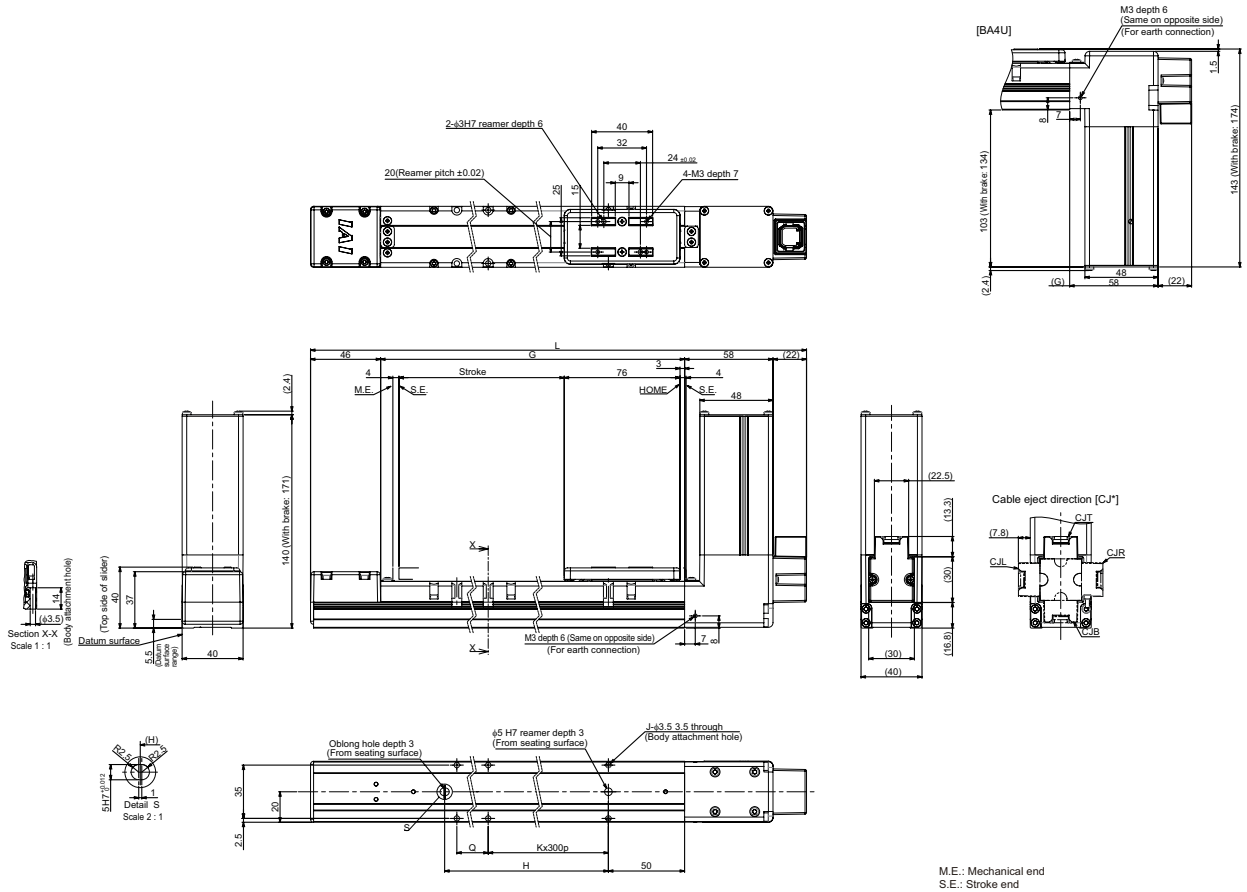

Stroke	L	G	H	J	K	Q	Mass [kg]			
							BA4		BA4U	
							W/O Brake	With Brake	W/O Brake	With Brake
300	517	391	300	4	0	291	1.7	1.9	1.9	2.1
400	617	491	400	6	1	91	1.8	2.0	2.0	2.2
500	717	591	500	6	1	191	2.0	2.2	2.2	2.4
600	817	691	600	6	1	291	2.1	2.3	2.3	2.5
700	917	791	700	8	2	91	2.3	2.5	2.5	2.7
800	1017	891	800	8	2	191	2.4	2.6	2.6	2.8
900	1117	991	900	8	2	291	2.5	2.7	2.7	2.9
1000	1217	1091	1000	10	3	91	2.7	2.9	2.9	3.1
1100	1317	1191	1100	10	3	191	2.8	3.0	3.0	3.2
1200	1417	1291	1200	10	3	291	2.9	3.1	3.1	3.3

5.2 RCP5-BA6/BA6U

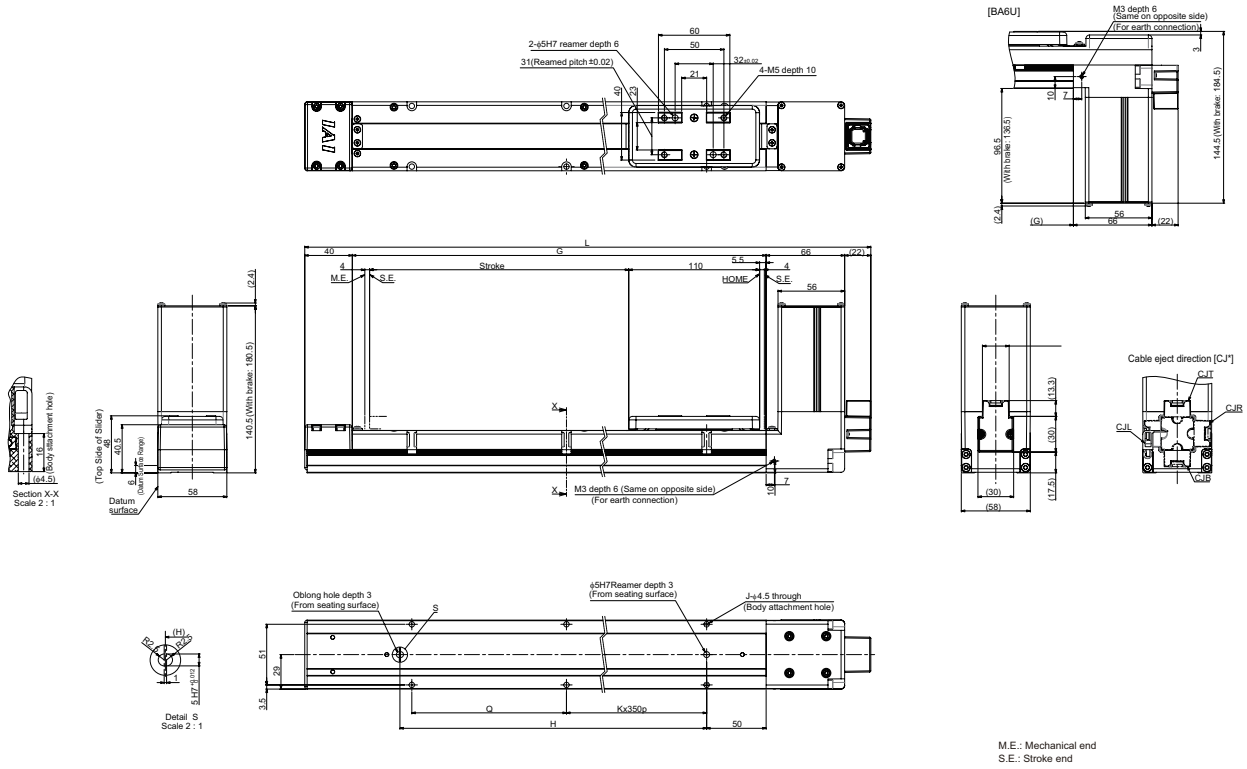

Stroke	L	G	H	J	K	Q	Mass [kg]			
							BA6		BA6U	
							W/O Brake	With Brake	W/O Brake	With Brake
300	558	430	340	4	0	330	2.2	2.6	2.4	2.8
400	658	530	440	6	1	80	2.4	2.8	2.6	3.0
500	758	630	540	6	1	180	2.7	3.1	2.9	3.3
600	858	730	640	6	1	280	2.9	3.3	3.1	3.5
700	958	830	740	6	1	380	3.1	3.5	3.3	3.7
800	1058	930	840	8	2	130	3.3	3.7	3.5	3.9
900	1158	1030	940	8	2	230	3.5	3.9	3.7	4.1
1000	1258	1130	1040	8	2	330	3.7	4.1	3.9	4.3
1100	1358	1230	1140	10	3	80	3.9	4.3	4.1	4.5
1200	1458	1330	1240	10	3	180	4.2	4.6	4.4	4.8
1300	1558	1430	1340	10	3	280	4.4	4.8	4.6	5.0
1400	1658	1530	1440	10	3	380	4.6	5.0	4.8	5.2
1500	1758	1630	1540	12	4	130	4.8	5.2	5.0	5.4
1600	1858	1730	1640	12	4	230	5.0	5.4	5.2	5.6
1700	1958	1830	1740	12	4	330	5.2	5.6	5.4	5.8
1800	2058	1930	1840	14	5	80	5.4	5.8	5.6	6.0
1900	2158	2030	1940	14	5	180	5.6	6.0	5.8	6.2
2000	2258	2130	2040	14	5	280	5.9	6.3	6.1	6.5
2100	2358	2230	2140	14	5	380	6.1	6.5	6.3	6.7
2200	2458	2330	2240	16	6	130	6.3	6.7	6.5	6.9

5.3 RCP5-BA7/BA7U

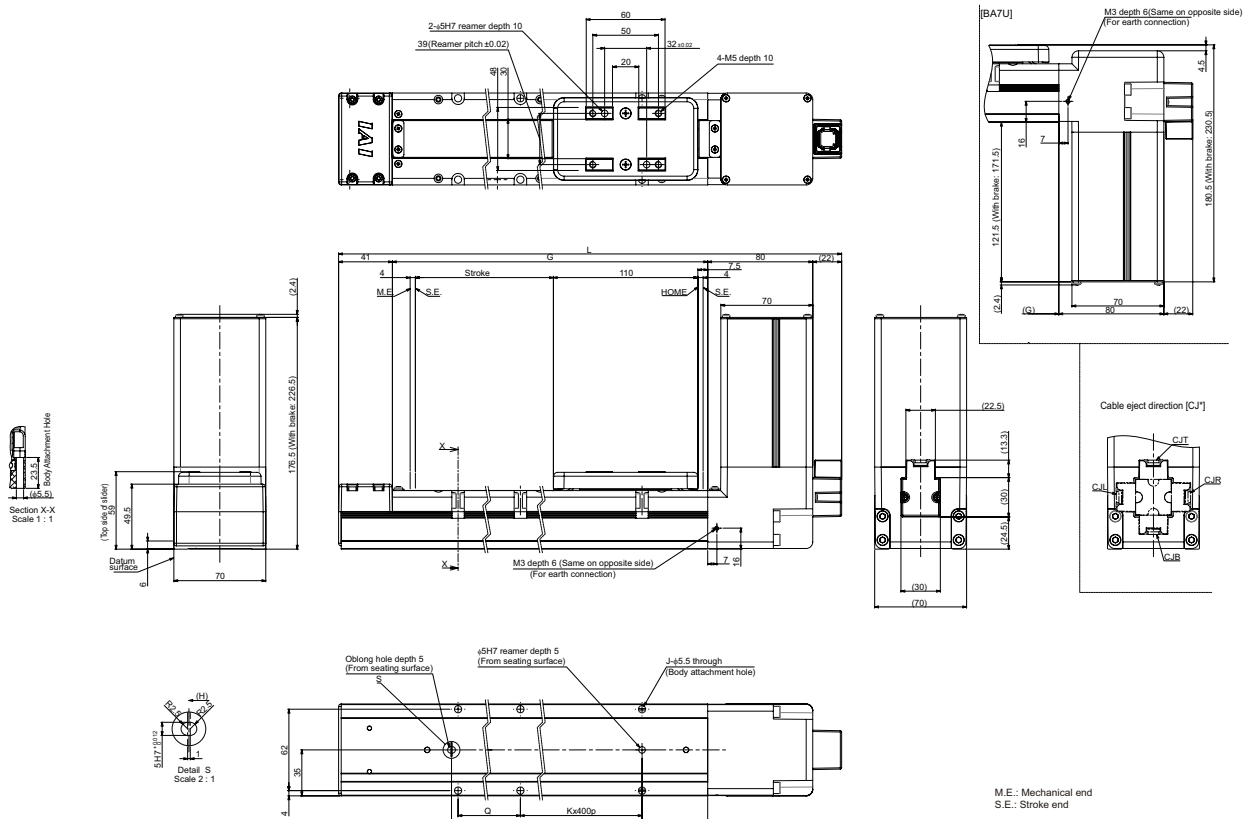

Stroke	L	G	H	J	K	Q	Mass [kg]			
							BA7		BA7U	
							W/O Brake	With Brake	W/O Brake	With Brake
300	578	435	340	4	0	335	3.8	4.4	4.0	4.6
400	678	535	440	4	0	435	4.1	4.7	4.3	4.9
500	778	635	540	6	1	135	4.4	5.0	4.6	5.2
600	878	735	640	6	1	235	4.8	5.4	5.0	5.6
700	978	835	740	6	1	335	5.1	5.7	5.3	5.9
800	1078	935	840	6	1	435	5.4	6.0	5.6	6.2
900	1178	1035	940	8	2	135	5.8	6.4	6.0	6.6
1000	1278	1135	1040	8	2	235	6.1	6.7	6.3	6.9
1100	1378	1235	1140	8	2	335	6.5	7.1	6.7	7.3
1200	1478	1335	1240	8	2	435	6.8	7.4	7.0	7.6
1300	1578	1435	1340	10	3	135	7.1	7.7	7.3	7.9
1400	1678	1535	1440	10	3	235	7.5	8.1	7.7	8.3
1500	1778	1635	1540	10	3	335	7.8	8.4	8.0	8.6
1600	1878	1735	1640	10	3	435	8.1	8.7	8.3	8.9
1700	1978	1835	1740	12	4	135	8.5	9.1	8.7	9.3
1800	2078	1935	1840	12	4	235	8.8	9.4	9.0	9.6
1900	2178	2035	1940	12	4	335	9.1	9.7	9.3	9.9
2000	2278	2135	2040	12	4	435	9.5	10.1	9.7	10.3
2100	2378	2235	2140	14	5	135	9.8	10.4	10.0	10.6
2200	2478	2335	2240	14	5	235	10.2	10.8	10.4	11.0
2300	2578	2435	2340	14	5	335	10.5	11.1	10.7	11.3
2400	2678	2535	2440	14	5	435	10.8	11.4	11.0	11.6
2500	2778	2635	2540	16	6	135	11.2	11.8	11.4	12.0
2600	2878	2735	2640	16	6	235	11.5	12.1	11.7	12.3

6. Life

The mechanical life of the actuator is represented by the guide that receives the moment load mostly. Operation life of the linear guide is to be determined by the total driving distance which can reach without having 90% flaking (peeling on rail surface). Operation life can be figured out with the calculation method shown below.

6.1 How to Calculate Operation Life

For the operation life of the linear guide, use the dynamic allowable moment stated in 1.2 Specifications, and figure out with the formula below.

$$L = \left(\frac{C_M}{M} \right)^3 \cdot 5,000\text{km}$$

L: Operation life (Km)
M: Moment to work (N•m)

C_M : Allowable dynamic load moment (N•m)
5,000km: Standard rated life of ROBO Cylinder

In addition, have a calculation for the drop of life with the formula below if there is a concern that the life could drop due to the condition of vibration or way to be attached.

$$L = \left(\frac{C_M}{M} \cdot \frac{f_{ws}}{f_w} \cdot \frac{1}{f_a} \right)^3 \cdot 5,000\text{km}$$

L: Operation life (Km)
M: Moment to work (N•m)

C_M : Allowable dynamic load moment (N•m)

f_{ws} : Standard operational coefficient f_w : Load coefficient f_a : Attachment coefficient
5,000km: Standard rated life of ROBO Cylinder

Explained below is regarding the standard operational coefficient f_{ws} , load coefficient f_w and attachment coefficient f_a .

Refer to the contents below to set them up.

[Standard operational coefficient f_{ws}]

For ROBO Cylinders described in this manual, $f_{ws} = 1.2$. It is a coefficient defined for each model, some models such as RCS3 high-speed type is 1.35.

[Load coefficient f_w]

It is a coefficient to consider the life drop due to operational conditions.

Load coefficient f_w	Operational Conditions	Reference for acceleration/deceleration
1.0 to 1.5	Small vibration or impact in slow operation	0.5G or less

[Attachment coefficient f_a]

Attachment coefficient f_a is a coefficient to consider the life drop due to the condition of actuator attachment.

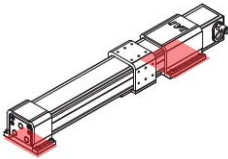
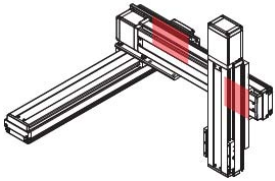
Attachment coefficient f_a	1.0	1.2	1.5
	Attachment in whole area	Attachment on both ends	Attachment on spots
Condition of attachment			

* As the figures are those in common for each manual, they are not for RCP5 Belt Type.

Replace to figures for RCP5 Belt Type and select the attachment coefficient.

* Even when in attachment in whole area and the actuator is seated in the whole length of the product, select 1.2 or 1.5 for the attachment coefficient depending on the position of screw fixing.

* For attachment in whole area, use all of the through holes on the seat surface to fix.

6.2 Operation Life

The operation life depends on the moment to work. With light load, it will be longer than 5,000km, the standard rated life. With no consideration of vibration and attachment condition, the operation life is 40,000km according to the calculation with formula in the previous page under assumption that 0.5Cm (half of dynamic allowable moment) of moment is applied on. It shows that it can be 8 times longer than the standard rated life, which is 5,000km.

7. Warranty

7.1 Warranty Period

One of the following periods, whichever is shorter:

- 18 months after shipment from IAI
- 12 months after delivery to the specified location
- 2,500 hours of operation

7.2 Scope of the Warranty

Our products are covered by warranty when all of the following conditions are met. Faulty products covered by warranty will be replaced or repaired free of charge:

- (1) The breakdown or problem in question pertains to our product as delivered by us or our authorized dealer.
- (2) The breakdown or problem in question occurred during the warranty period.
- (3) The breakdown or problem in question occurred while the product was in use for an appropriate purpose under the conditions and environment of use specified in the instruction manual and catalog.
- (4) The breakdown of problem in question was caused by a specification defect or problem, or by a quality issue with our product.

Note that breakdowns due to any of the following reasons are excluded from the scope of warranty:

- [1] Anything other than our product
- [2] Modification or repair performed by a party other than us (unless we have approved such modification or repair)
- [3] Anything that could not be easily predicted with the level of science and technology available at the time of shipment from our company
- [4] A natural disaster, man-made disaster, incident or accident for which we are not liable
- [5] Natural fading of paint or other symptoms of aging
- [6] Wear, depletion or other expected result of use
- [7] Operation noise, vibration or other subjective sensation not affecting function or maintenance

Note that the warranty only covers our product as delivered and that any secondary loss arising from a breakdown of our product is excluded from the scope of warranty.

7.3 Honoring the Warranty

As a rule, the product must be brought to us for repair under warranty.

7.4 Limited Liability

- (1) We shall assume no liability for any special damage, consequential loss or passive loss such as a loss of expected profit arising from or in connection with our product.
- (2) We shall not be liable for any program or control method created by the customer to operate our product or for the result of such program or control method.

7.5 Conditions of Conformance with Applicable Standards/Regulations, Etc., and Applications

- (1) If our product is combined with another product or any system, device, etc., used by the customer, the customer must first check the applicable standards, regulations and/or rules. The customer is also responsible for confirming that such combination with our product conforms to the applicable standards, etc. In such a case we will not be liable for the conformance of our product with the applicable standards, etc.
- (2) Our product is for general industrial use. It is not intended or designed for the applications specified below, which require a high level of safety. Accordingly, as a rule our product cannot be used in these applications. Contact us if you must use our product for any of these applications:
 - [1] Medical equipment pertaining to maintenance or management of human life or health
 - [2] A mechanism or mechanical equipment intended to move or transport people (such as a vehicle, railway facility or aviation facility)
 - [3] Important safety parts of mechanical equipment (such as safety devices)
 - [4] Equipment used to handle cultural assets, art or other irreplaceable items
- (3) Contact us at the earliest opportunity if our product is to be used in any condition or environment that differs from what is specified in the catalog or instruction manual.

7.6 Other Items Excluded from Warranty

The price of the product delivered to you does not include expenses associated with programming, the dispatch of engineers, etc. Accordingly, a separate fee will be charged in the following cases even during the warranty period:

- [1] Guidance for installation/adjustment and witnessing of test operation
- [2] Maintenance and inspection
- [3] Technical guidance and education on operating/wiring methods, etc.
- [4] Technical guidance and education on programming and other items related to programs

Change History

Revision Date	Description of Revision
May 2015	First edition
May 2015	1B edition Pg. 9 Changed from “Planned to be complied” to “O” as got complied with CE Mark Machinery Directive
July 2015	1C edition Pg. 72 Correction made to External Dimensions of BA6U
August 2015	1D edition Pg. 12, 18 Note added to state option to change direction for cable ejection has to be selected Pg. 13, 14 Note added that it is performance when high-output setting is effective Pg. 49 IAI maintenance part codes added for belt for replacement
October 2015	1E edition Pg. 15 Correction made Graph horizontal axis unit [m/s] → [mm/s] Pg. 16, 17 Specifications added for velocity and payload when high-output setting is ineffective



IAI Corporation

Head Office: 577-1 Obane Shimizu-KU Shizuoka City Shizuoka 424-0103, Japan
TEL +81-54-364-5105 FAX +81-54-364-2589
website: www.iai-robot.co.jp/

Technical Support available in USA, Europe and China

IAI America, Inc.

Head Office: 2690 W. 237th Street, Torrance, CA 90505
TEL (310) 891-6015 FAX (310) 891-0815
Chicago Office: 110 East State Parkway, Schaumburg, IL 60173
TEL (847) 908-1400 FAX (847) 908-1399
Atlanta Office: 1220 Kennestone Circle, Suite 108, Marietta, GA 30066
TEL (678) 354-9470 FAX (678) 354-9471
website: www.intelligentactuator.com

IAI Industrieroboter GmbH

Ober der Röth 4, D-65824 Schwalbach am Taunus, Germany
TEL 06196-88950 FAX 06196-889524

IAI (Shanghai) Co., Ltd.

SHANGHAI JIAHUA BUSINESS CENTER A8-303, 808, Hongqiao Rd. Shanghai 200030, China
TEL 021-6448-4753 FAX 021-6448-3992
website: www.iai-robot.com

IAI Robot (Thailand) Co., Ltd.

825, PhairojKijja Tower 12th Floor, Bangna-Trad RD., Bangna, Bangkok 10260, Thailand
TEL +66-2-361-4458 FAX +66-2-361-4456