

Unit-connecting 1~16-axis Position &
1~8-axis Programm Controller Series

R-unit

RCON



Positioner Type

RSEL



Program Type

REC



EleCylinder Drive Unit

IAI's new controller series

R-unit

This series of unit-connecting controllers allows you to freely select and combine connected actuators and control methods.

Positioner Type

RCON



R-unit



Program Type

RSEL



EleCylinder Drive Unit

REC

Unit-connecting controllers support a wide array of combinations!

Combine a driver unit with the exact number of required axes for a more compact controller and reduced installation space.

This allows for mixed control of an actuator with both a 24V motor and 230V motor.

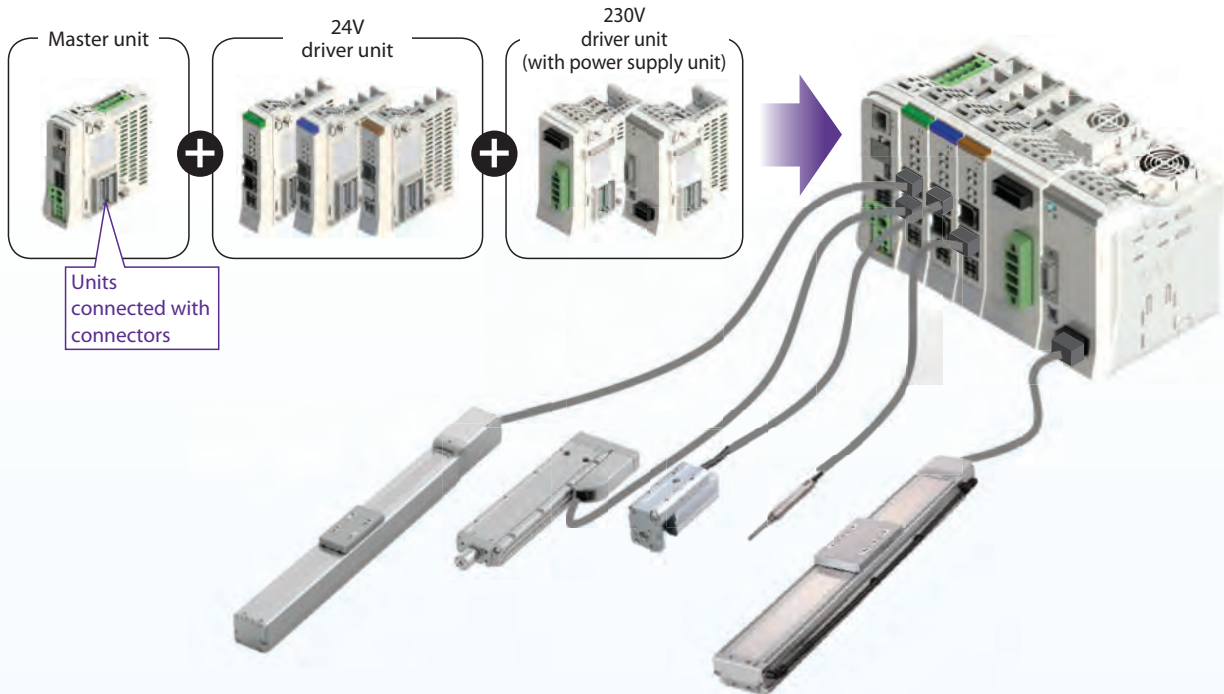

Use the same driver units

The system can be changed just by switching out the master unit based on the control method. This allows the same driver units to be used.

R-unit

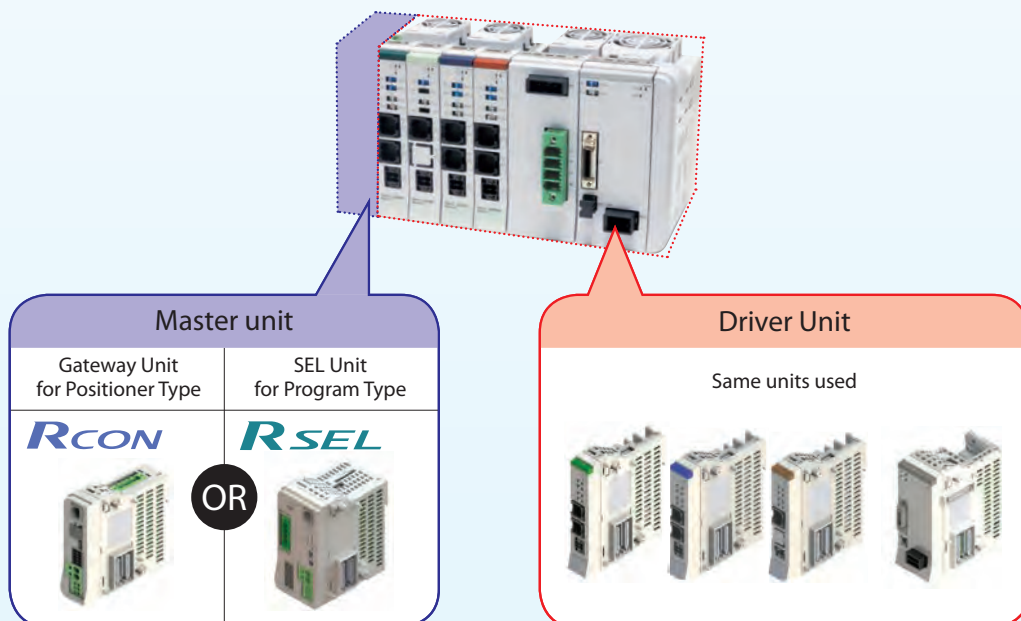

Saves space
inside the control panel



RCON

RCON is recommended for actuators with two axes or more.

Up to 2 axes of actuators can be connected to one driver unit with 22mm width, making it ideal for saving space in the control panel.

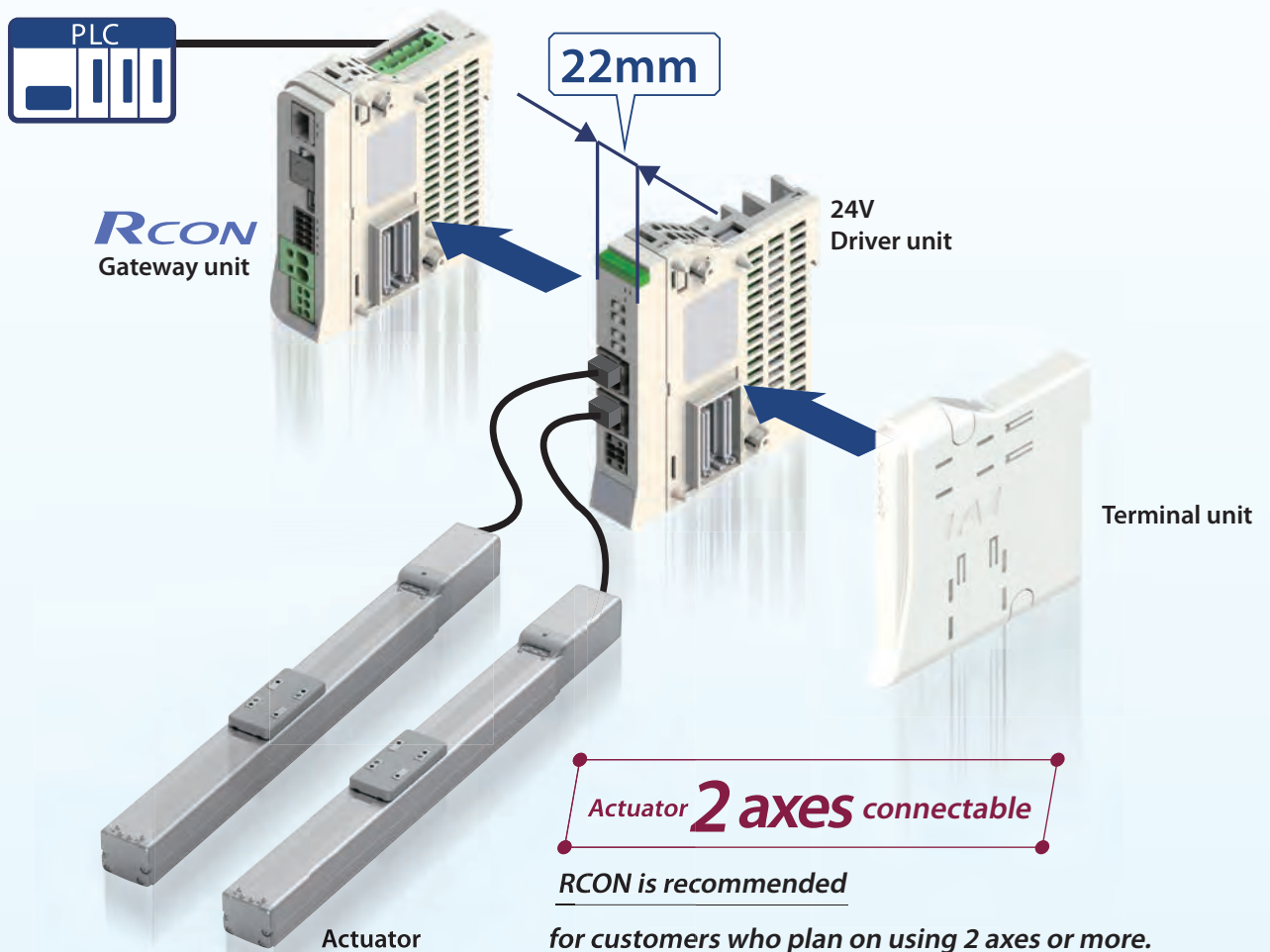

Up to 16 axes*1 of actuators can be connected.

There will be no wasted space as only the necessary driver units will be added.

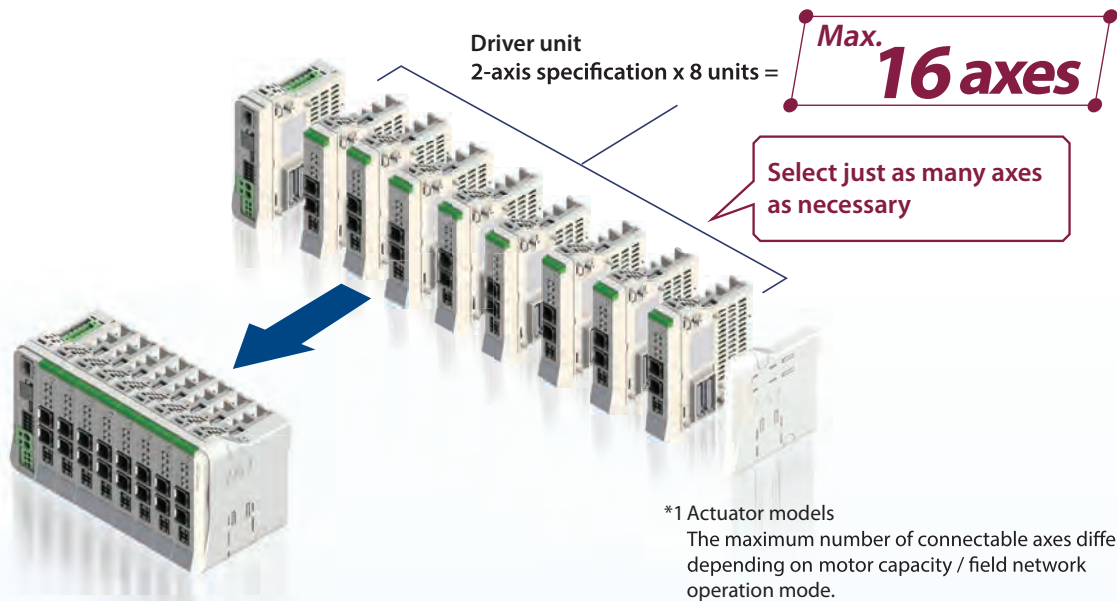

Saves up to 85%*2 of control panel space and reduces costs by as much as 60%.

*2 IAI product comparison

Up to about 85% of control panel space can be saved, compared with models that connect a 1-axis actuator to a single driver unit.

The conventional type (Comparison example below) requires network options installed to match the number of controllers. RCON can control driver units for up to 16 axes of actuators with a single gateway, allowing cost reductions up to 60%. It is especially recommended when using multiple axes.

PCON-CB x 16 units

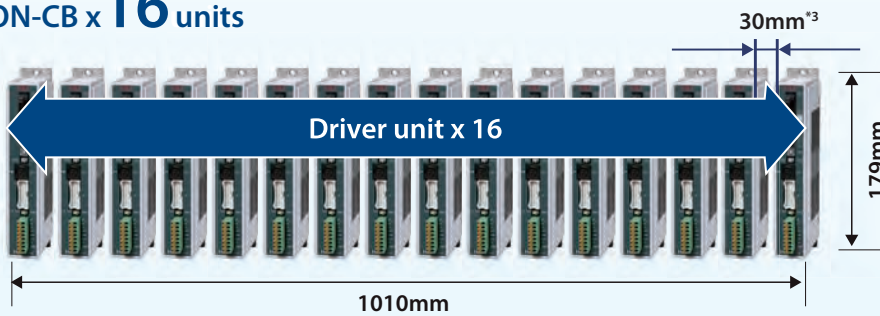

PCON-CB
PROFINET IO specification x 16 units

*3 Minimum distance required for natural heat dissipation of the controller



RCON x 16-axis connection specification

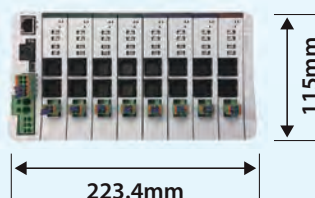

RCON
PROFINET IO specification
pulse motor 16 axes

RSEL

Compact program controller that connects up to 16 axes*¹ of actuators

Supports both linear and arc interpolation operations.
Also allows control of connected axes to be split into two groups.

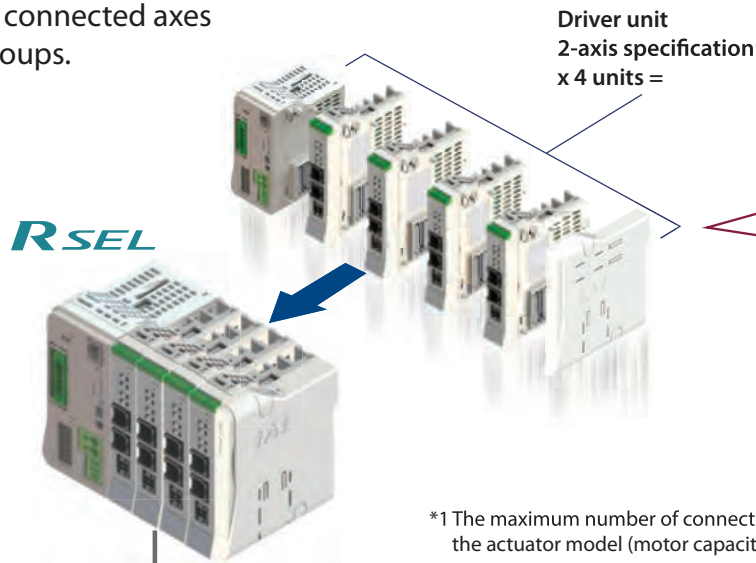

*1 The maximum number of connectable axes differs depending on the actuator model (motor capacity).

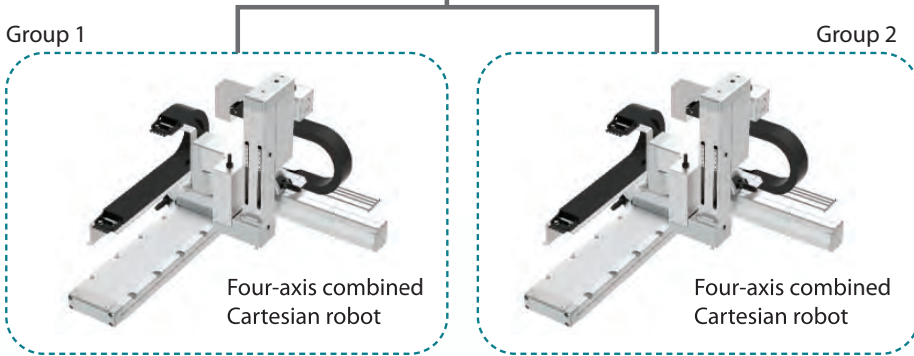

Max. 67%*² space savings inside the control panel *² IAI product comparison

Up to about 67% of control panel space can be saved, compared with models that connect a 4-axis actuator to a single driver unit.

MSEL x 2 units (8-axis connection)

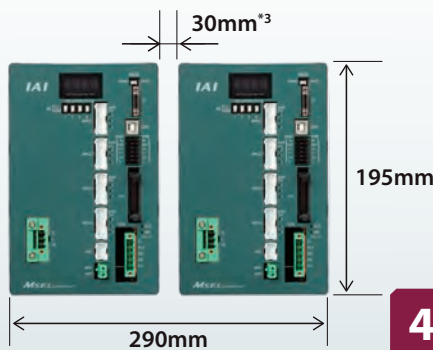

MSEL PROFINET IO specification
8 axes (4 axes x 2 units)

43% cost reduction

*³ Minimum distance required for natural heat dissipation of the controller

RSEL x 8-axis connection specification

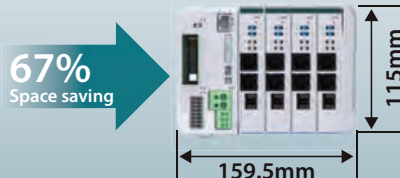

RSEL
PROFINET IO specification
pulse motor 8 axes

Connect EleCylinder to a field network

This field network connection unit is specifically for use with EleCylinder. It allows up to 16 axes of EleCylinder to be connected. It is ideal for saving wiring and space inside the control panel.

EC connection unit
4-axis specification
x 4 units =

Max.
16 axes

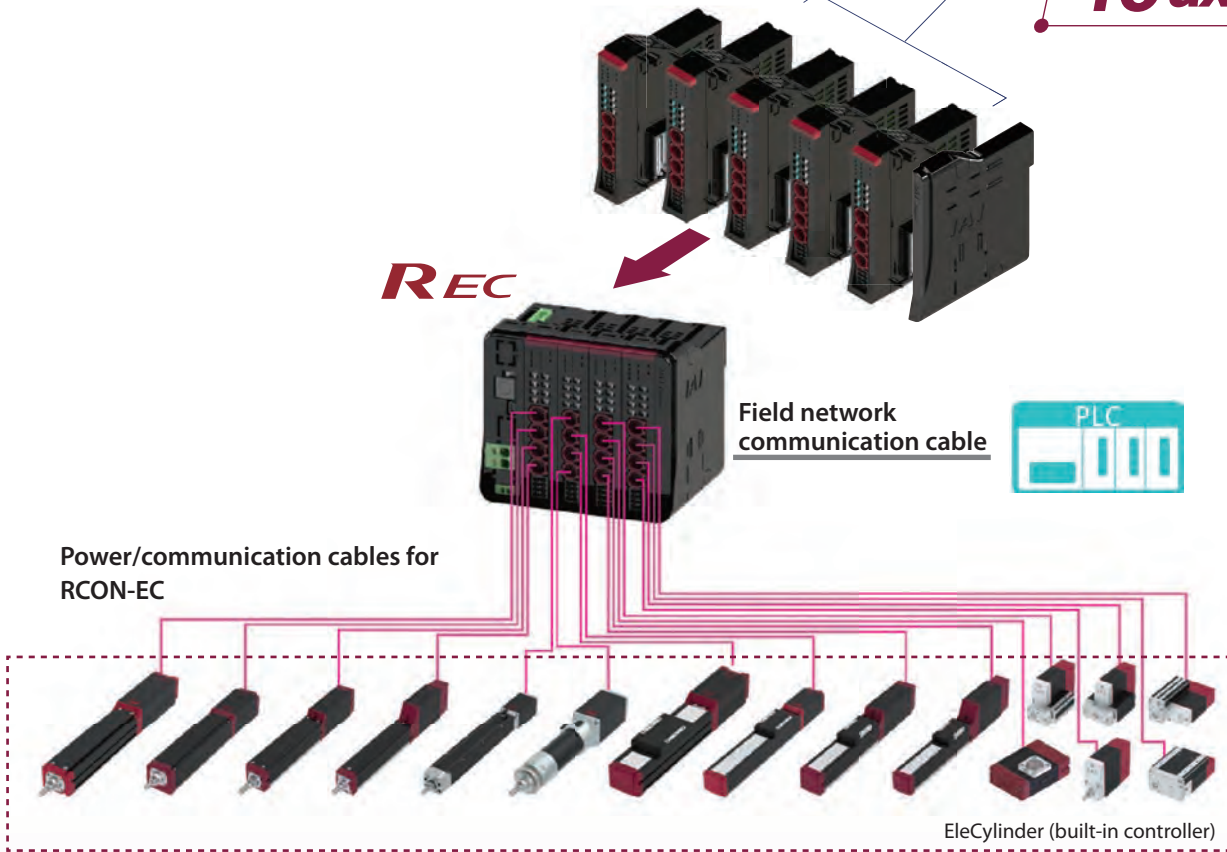

EC connection unit can be connected with other driver units connected to RCON/RSEL

EleCylinder can be used together with RoboCylinders and single-axis robots when it is connected to the EC connecting unit.

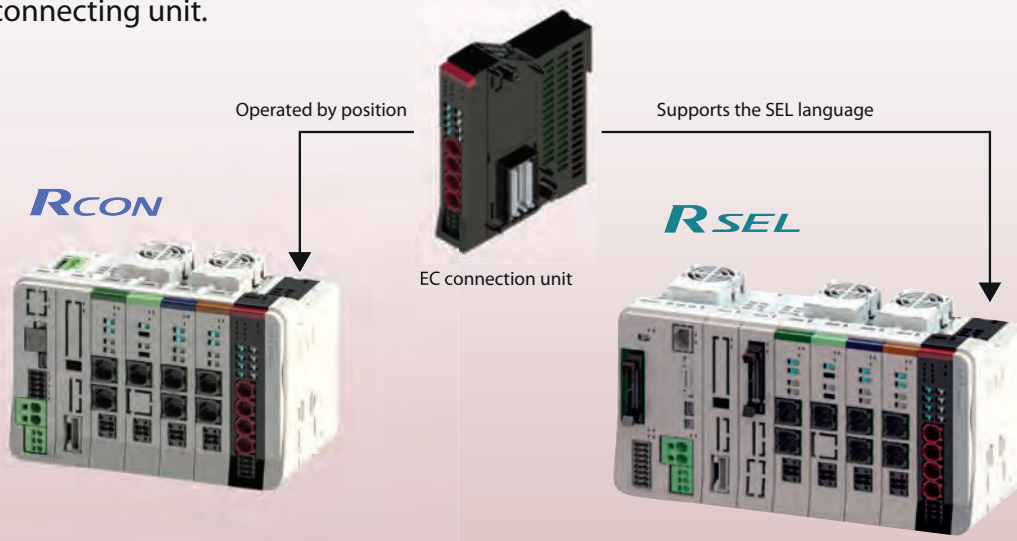

Seven high-performance functions that only IAI is capable of delivering

High function 1 *Compatibility: No.1 in the industry with seven field network types supported*

IAI controller can be connected to various field networks as remote I/O station.

* Connectable networks differ depending on the series.

CC-Link

CC-Link IE Field

DeviceNet™

EtherNet/IP™

EtherCAT®

PROFI[®]
BUS

PROFI[®]
NET

High function 2 *Supports controller installation environment temperatures of 0 ~ 55°C*

Install the optional fan unit to enable use in environments of 0~55°C without lowering actuator operating duty. (One fan is required for each SEL unit and for every two 24V driver units.) A fan unit is required for 230V power supply units and 230V driver units.

* Simple absolute units support 0~40°C.

REC supports 55°C without a fan.

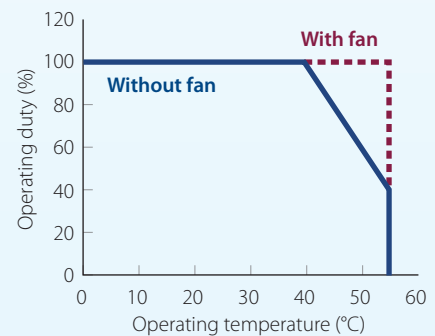
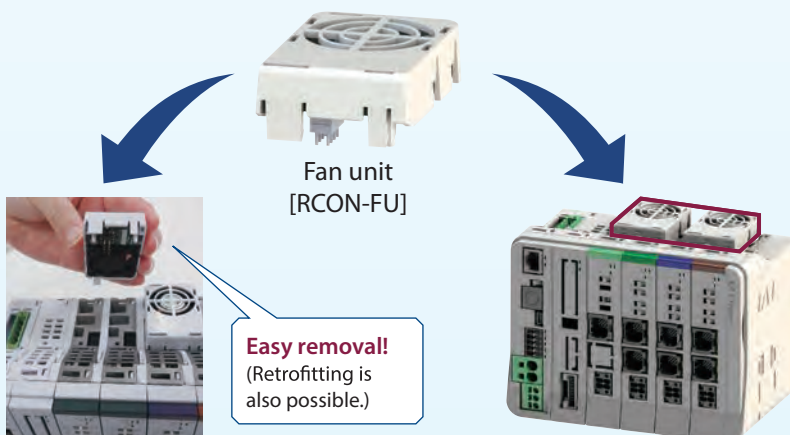

High function 3 Predictive maintenance/preventative maintenance function

R-units have a preventative maintenance function for the capacitor and a predictive maintenance function for the fan unit and actuator.

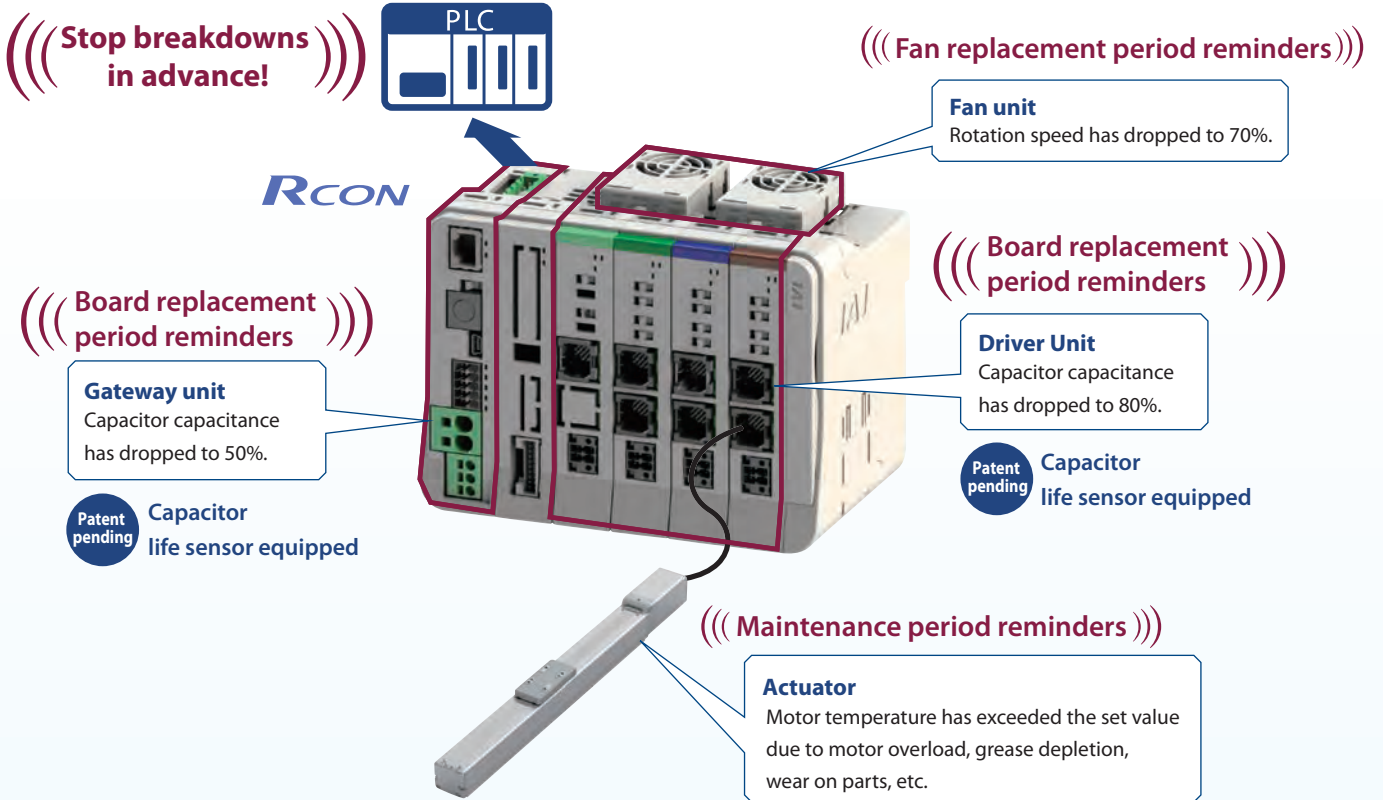

High function 4 Ethernet-equipped

Supports Ethernet connections. (Excluding REC.)

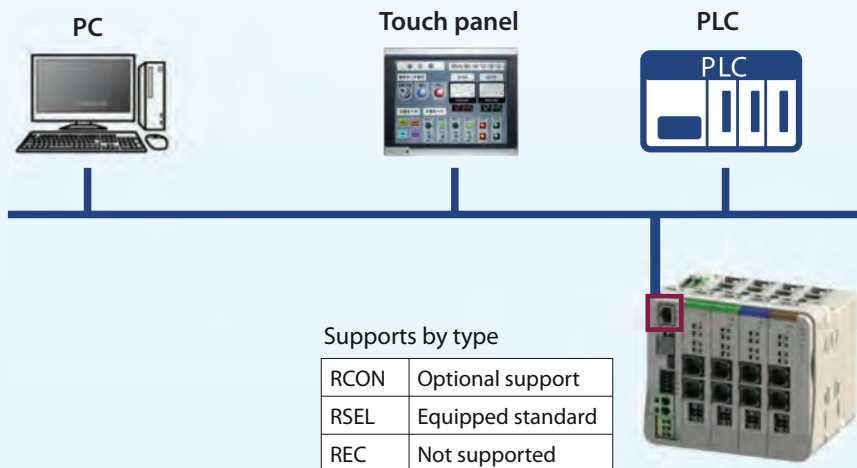

High function 5 Highest number of connection actuators in the industry! Can be connected with 947 IAI actuators*

* See P.46 for connectable actuators.

● Models with 24V motors

Supports actuators equipped with a battery-less absolute encoder as well as those with simple absolute encoders and incremental encoders.

RCP Series

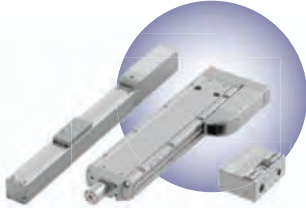

RCA Series



RCD Series



24V driver unit



WU Series



IK Series



EC Series

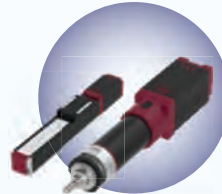

EC connection unit



● Models with 230V motors

These products are capable of driving actuators equipped with 230V motors and 60W to 750W motors. 230V driver units support actuators equipped with battery-less absolute encoders and incremental encoders.

When connecting to extension unit+ SCON, actuators equipped with 12W to 3300W motors are operable and all encoders are supported.

RCS Series

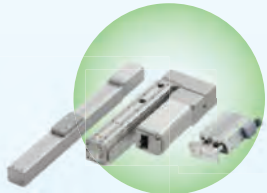

IS(D)B Series

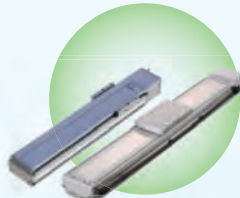

SSPA Series

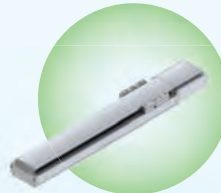

230V driver unit + power supply unit



NS(A) Series



DD(A) Series



ICSB Series

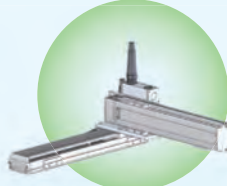

Extension unit + SCON connection

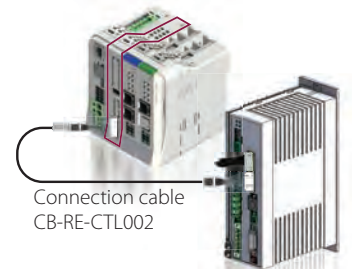

Connection cable
CB-RE-CTL002

High function 6 Motor power cutoff method can be selected

In accordance with customer safety function applications, the motor power cutoff method at emergency stop can be selected through the RCON wiring method.



High function 7 Helps visualize equipment with 24V power monitor

Helps visualize equipment.

The following IAI 24VDC power supply (PSA-24) monitoring can be output to a PLC via an R unit.

- Output voltage ● Output current ● Power load factor ● Total energizing time
- Internal temperature ● Low fan speed warning

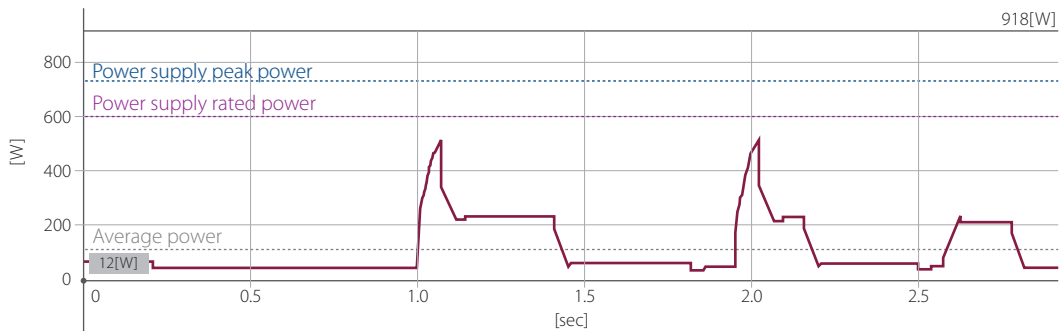

*The graph is a reference image.

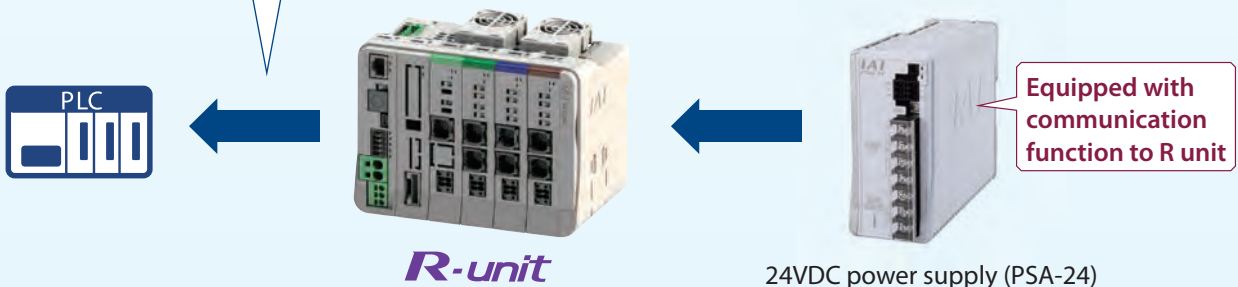

Easy start-up and maintenance.

The actuator movable parts for each axis can be moved forward/backward, even without a teaching pendant or PC teaching software.

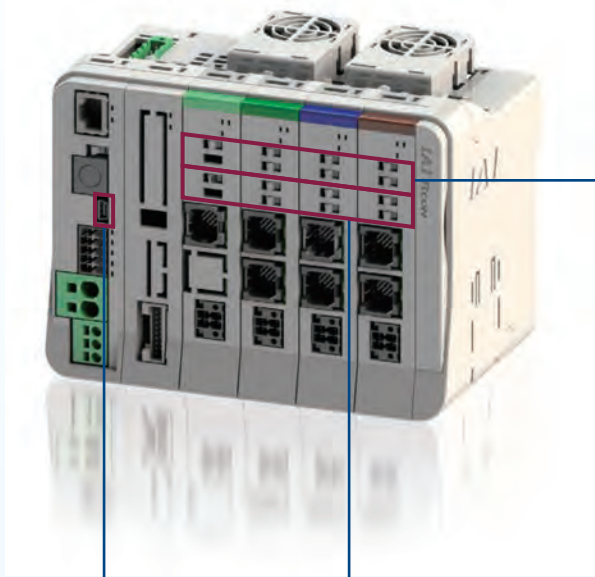

Each axis JOG (+/-) switch

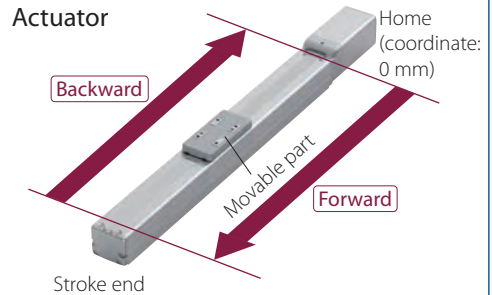
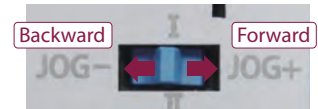

JOG switch enabled in manual mode with PC software/teaching pendant manual operation window closed.

Each axis brake release switch

Actuator

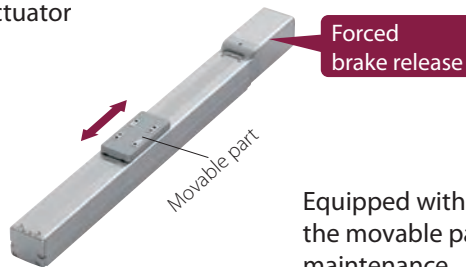

Equipped with a brake release switch for each axis, the movable parts can be moved by hand during maintenance.

USB port



Connection to a PC is possible using a commercial USB cable. Dedicated cables are not required.

*Compatible with miniUSB (mini-B).

Easy to program even for a beginner!

The PC-dedicated teaching software supports users.

Even beginners can operate easily because it shows operation procedures process by process from controller wiring to troubleshooting.



The PC-dedicated teaching software supporting screen (display example)

Controller's various wiring

Wiring work can be done smoothly.
Wiring necessary for start up can be done, referring to the PC-dedicated teaching software.



Network wiring setting

Operation method of peripheral devices is shown.
Host PLC setting examples are displayed in addition to the RCON setting procedure.



Actuator operation and adjustment

Operation procedures can be displayed according to your specific application

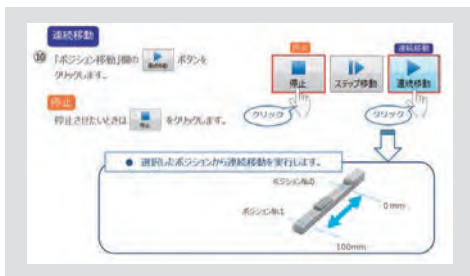

Troubleshooting

Even if it fails, it can be repaired immediately.
In case of a trouble, IAI's troubleshooting is displayed.



Easy to program even for a beginner!

The "SEL Programming Tool" of the PC-dedicated teaching software supports users.



The "SEL Programming Tool" generates SEL programs by arranging the items whose operations are defined. Therefore, programming is possible without learning the SEL language.

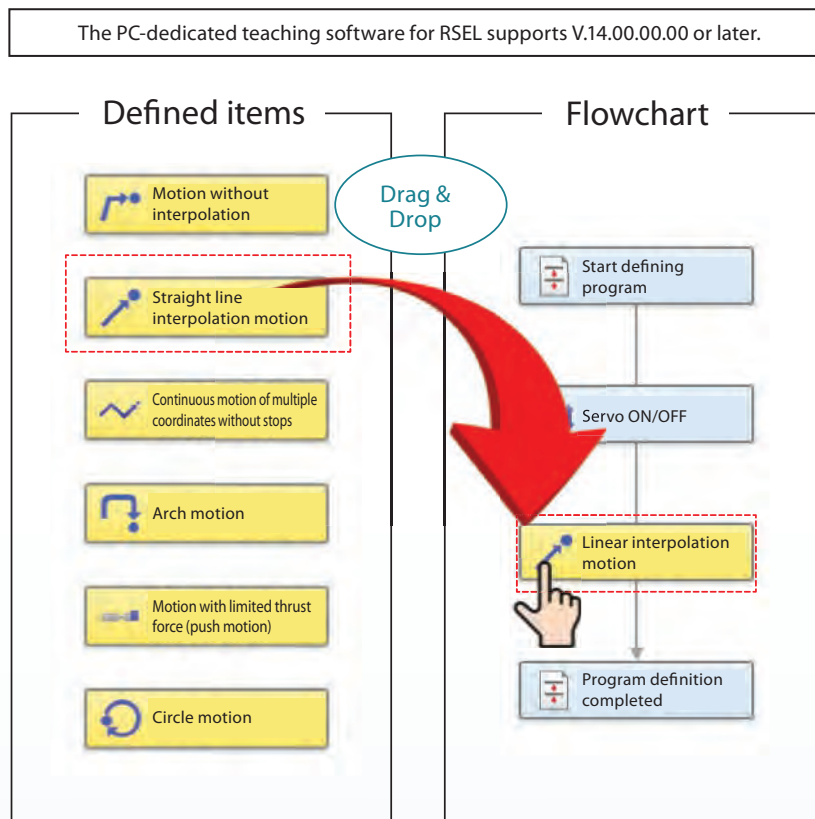

Execution

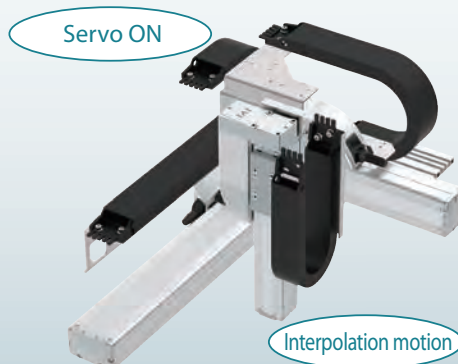

Troubleshooting using the teaching pendant

The program controller teaching pendant (TB-02/03) now offers troubleshooting functionality. It suggests solutions to problems using a series of YES/NO questions. (Supported by Ver. 2.70 or later.)



<Error details>

The screenshot shows the 'Error details' screen in the IAI Troubleshooting application. The screen has a blue header with a back arrow, a home icon, the title 'Troubleshooting', and a menu icon. Below the header are four tabs: 'Error display', 'Error list', 'Check model num.', and 'Inquiry'. The main content area is titled 'Error display' and contains the following information:

- Error No.:** 600
- Error level:** Cold start
- Name:** Encoder error
- Descr.:** Abnormal signal of encoder was detected. Or the encoder signal could not be communicated.
- Program No.:** 0
- Step No.:** 0
- Position No.:** 0
- Ax. No.:** 1
- Time (yy/mm/dd hh:mm:ss):** 20/04/29 02:18:48
- Detail code:** D19h E5h 34h 0h 44414C4Dh

At the bottom of the screen are two buttons: 'Troubleshooting' and 'Error reset'. A timestamp '2:30' is visible in the bottom right corner.

<Solution>

The screenshot shows the 'Solution' screen in the IAI Troubleshooting application. The screen has the same blue header and tabs as the previous screen. The main content area is titled '- Troubleshooting [Countermeasure] (600:Encoder error)'. It contains the following text:

- [Cause]** Wire disconnection or connector's contact failure of the cable connecting the actuator and controller.
- [Countermeasure]** Turn off the power of controller first, disconnect the cable connector (in red box), and fully insert the connector. If the alarm occurs again, the cable may be disconnected.

Below the text is an image of a cable connector being inserted into a controller's port. Red boxes highlight the connector and the port. At the bottom of the screen is an 'Error reset' button. A timestamp '2:31' is visible in the bottom right corner.

Motion control

Coming soon

The RCON supports motion networks.

RCON



EtherCAT

It is possible to use RCON together with third-party servo amplifiers, to synchronize with different types of motors and to perform interpolation control.

Connection image

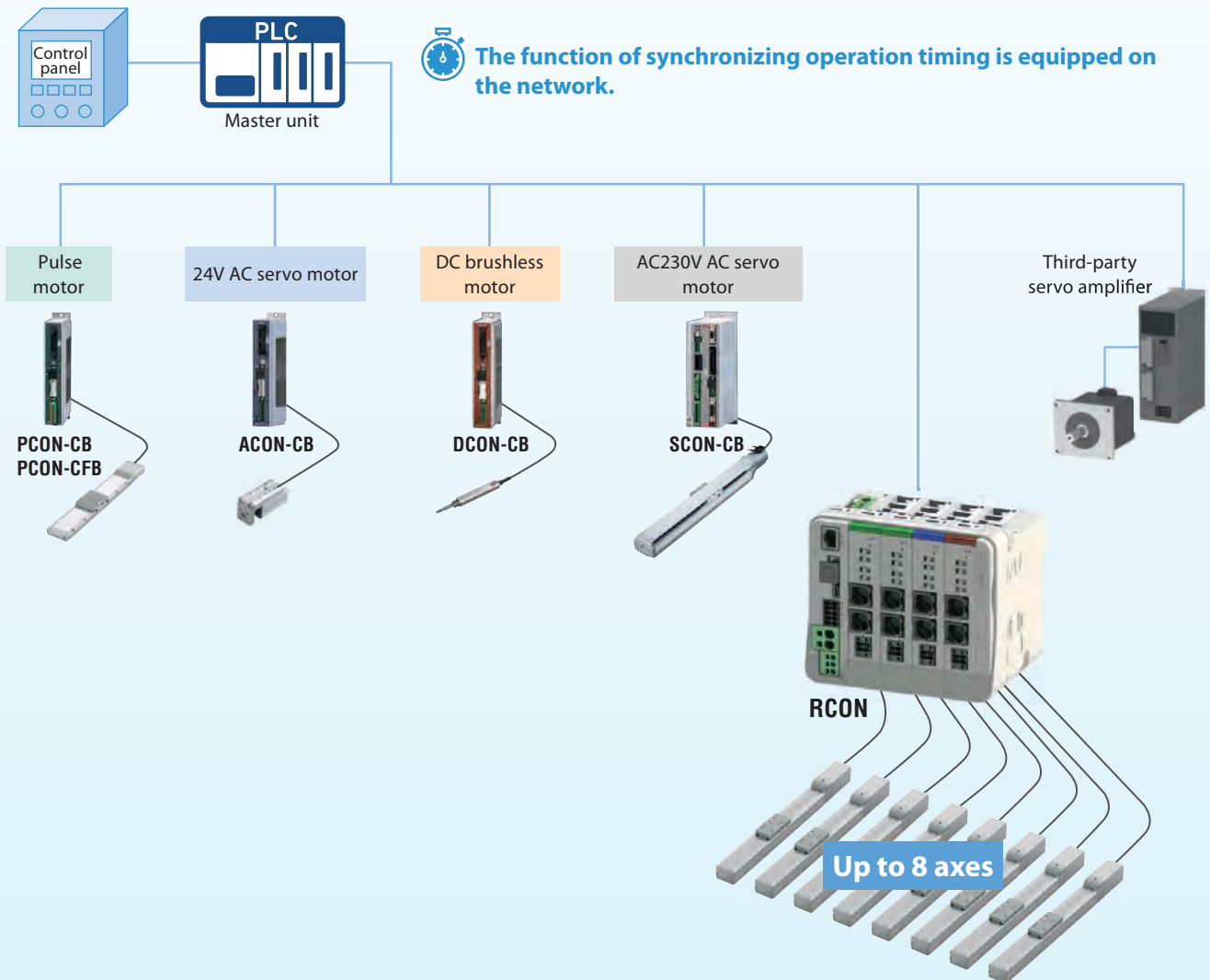

Touch panel connection

Setting, alteration and monitor of the data in the controller can be performed directly from the touch panel via serial communication.

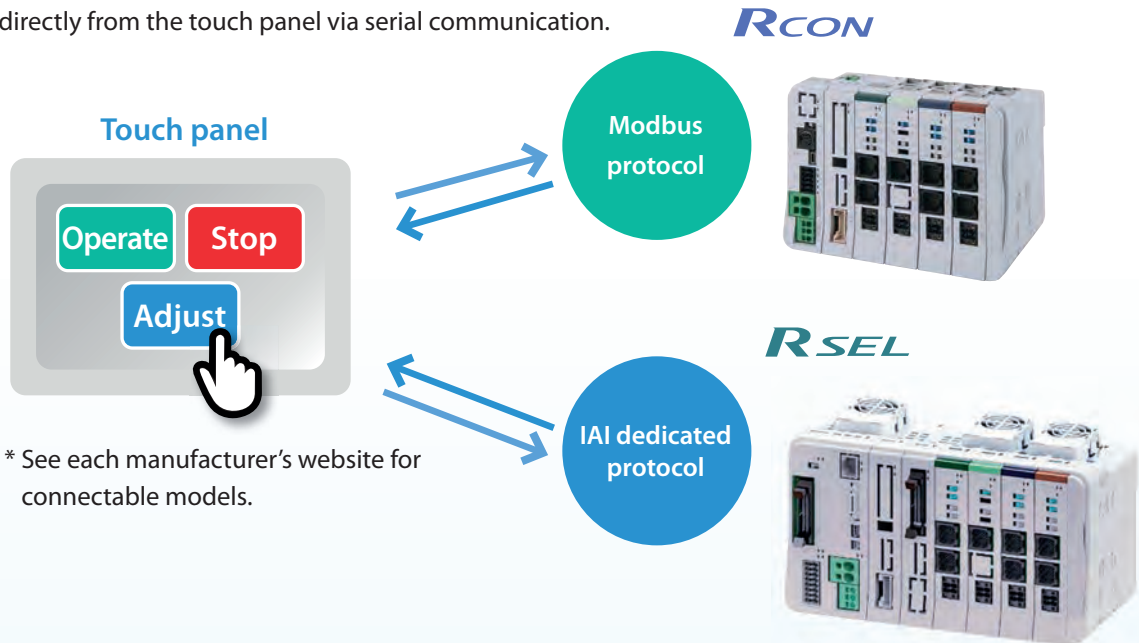

Serial communication protocol

The RSEL makes XSEL communication protocol in multiple channels possible. Conditions of the controller can be monitored by multiple devices.

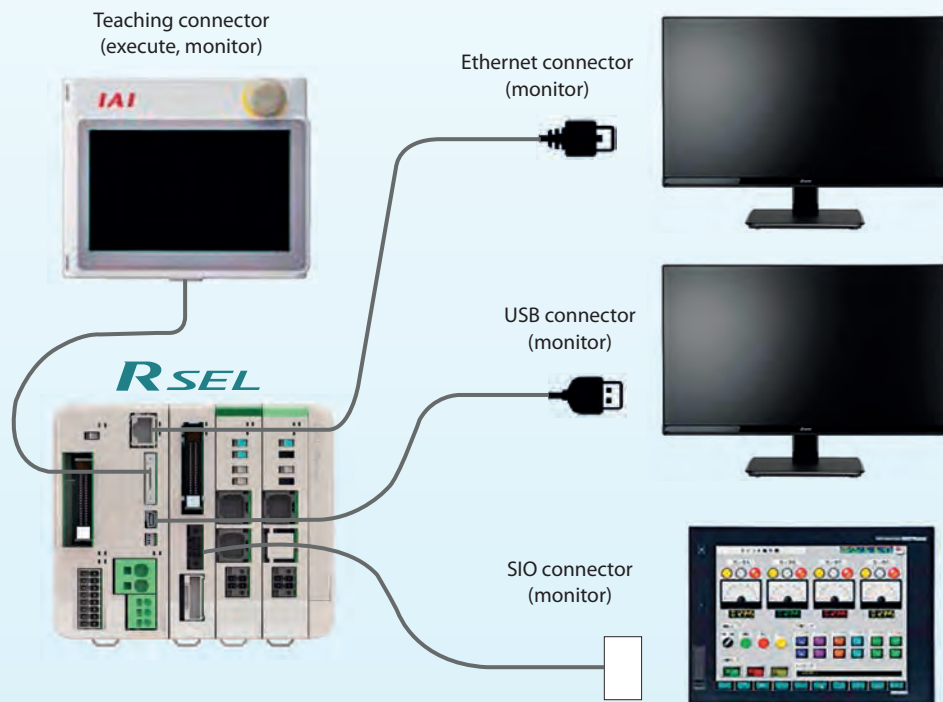

Model Selection

Select from three types of R-units, based on your operation method and models to connect.

Positioner Type

- For situations where the stop position will be registered in the position data, and then the position number will be specified for operation.

Max. number of connected axes:
16 axes



RCON

Refer to the selection pages beginning from P. 18

Program Type

- For situations where Cartesian coordinate system operation is performed for multiple axes combining single axes.

Max. number of connected axes:
16 axes



RSEL

Refer to the selection pages beginning from P. 25

EleCylinder Unit

- For situations where EleCylinder with ACR option is operated over a fieldbus.

Max. number of connected axes:
16 axes



REC

Refer to the selection pages beginning from P. 33

RCON

Selection Method

Step 1 Select the actuators to connect. (Up to 16 axes.)

<Selection example>



Step 2 Gateway unit selection

Select the gateway unit model from the network type.

Network type	Gateway unit model
	RCON-GW/GWG-CC
	RCON-GW/GWG-CIE
	RCON-GW/GWG-DV
	RCON-GW/GWG-EC
	RCON-GW/GWG-EP
	RCON-GW/GWG-PR
	RCON-GW/GWG-PRT

<Selection example>



Caution Only one gateway unit can be connected per system. Split this among two or more units to connect 17 or more axes or if the power capacity is exceeded.

Example: When connecting 18 axes

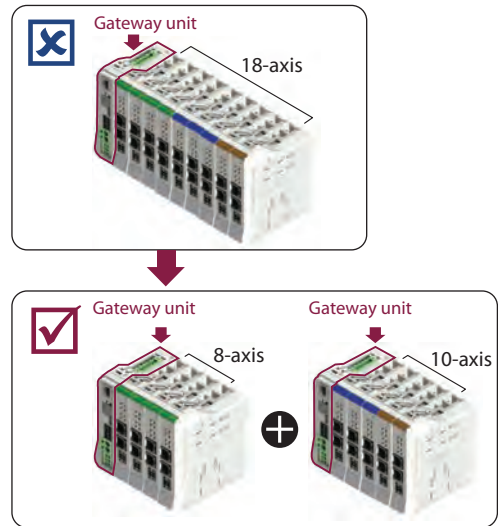

* GW: Gateway unit of standard specifications
 GWG: Gateway unit of safety category type.











Step 3 Classify actuator types into three categories.

*See P. 42 for actuators that cannot be connected.

Actuator type	Selected actuator
Models with 24V motors	<p><Selection example></p> <p>RCD RCP2 RCA2 RCP6</p>
Models with 230V motors	<p><Selection example></p> <p>RCS4 ISB DDA</p>
Eleccylinder (model with 24V motor)	<p><Selection example></p> <p>EC with ACR option</p>

Step 4 24V driver unit selection (models with 24V motors)

Select the driver unit model and number of units according to the series name and motor type of the actuator.

Actuator		24V driver unit			<Selection example>		
Series	Motor type	External view	Number of axes connected to actuator	Model	Classification	Required units	
RCP2 RCP3 RCP4 RCP5 RCP6	20P, 28P 35P, 42P 56P		2-axis specification	RCON-PC-2	 	1	← Selection 2
			1-axis specification	RCON-PC-1		1	← Selection 2
	High thrust motor 56SP, 60P 86P		1-axis specification	RCON-PCF-1		1	← Selection 2
RCA RCA2	2 5 10 20, 20S 30		2-axis specification	RCON-AC-2	 	1	← Selection 2
			1-axis specification	RCON-AC-1	-	-	
RCD	3D		2-axis specification	RCON-DC-2	-	-	
			1-axis specification	RCON-DC-1		1	← Selection 2

Step 5 Simple absolute unit selection

For actuators which are to use the simple absolute specification, select a number of simple absolute units (RCON-ABU-A/P) according to the number of axes.

*Connect to the driver unit with a cable (CB-ADPC-MPA005).
The cable is supplied with the simple absolute unit.

Note: The ambient operating temperature of the simple absolute unit is within the range of 0~40°C.



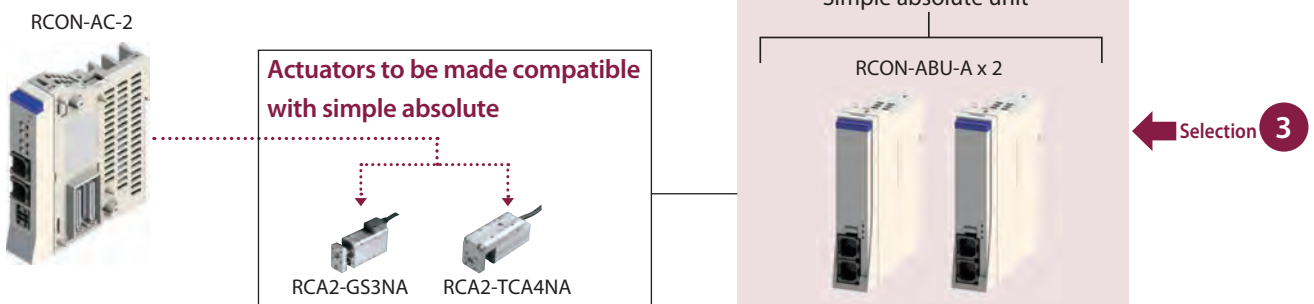

<Selection example>

This is an example in which a 2-axis RCA2 Series actuator is selected for simple absolute specification.





Step 6 EC connection unit selection (EleCylinder model)

To connect an EC Series product, select the required number of connection units based on the number of units for connecting EC.

Actuator		EC connection unit			<Selection example>		
Series	Motor type	External view	Number of axes connected to actuator	Model	Classification	Required units	
EC	28P, 35P 42P, 56P		4-axis specification	RCON-EC-4		1	← Selection 4







Step 7 Classify models with 230V motors into two categories.

Models are classified as axes connected to a 230V driver unit and axes connected to an extension unit.

Connection unit	Actuator specifications	Selected actuator
230V driver unit	Specification that meets all conditions below (Motor wattage [W]) 60W~750W (Encoder type) Incremental Battery-less Absolute	 RCS4-RA6C-WA-100  ISB-LXM-WA-200
Extension unit	Specification other than above	 DDA-LT18CS-AM-200 *This is because the absolute multi-rotation specification cannot be connected using a 230V driver unit.



Step 8 230V driver unit selection

Select one 230V power supply unit and a number of driver units according to the actuators to connect.

Unit name	External view	Number of axes connected to actuator	Model	<Selection example>	
				Classification	Required units
230V power supply unit		-	RCON-PS2-3	-	1 
230V driver unit		1-axis specification	RCON-SC-1	 RCS4  ISB	2 



Step 9 Extension unit selection

(1) Select one if there are any actuators connected with an expansion unit.

Unit name	External view	Number of axes connected to actuator	Model	<Selection example>	
				Classification	Required units
SCON extension unit		Max. 16 axes	RCON-EXT	 DDA	1 

(2) Select a number of controllers (SCON-CB) to connect through the expansion unit according to the number of connected actuators.

*A number of SCON-CBs must be purchased according to the number of connected axes. (Max. number of connections: 16 axes.)

Controller	External view	Number of axes connected to actuator	I/O type	<Selection example>	
				Classification	Required units
SCON-CB/CGB		1-axis specification	SCON-**-RC-*	 DDA	1 

● Example of connecting an extension unit and SCON-CB

One cable (CB-RE-CTL002) is supplied as standard with SCON-CB for RCON connection.

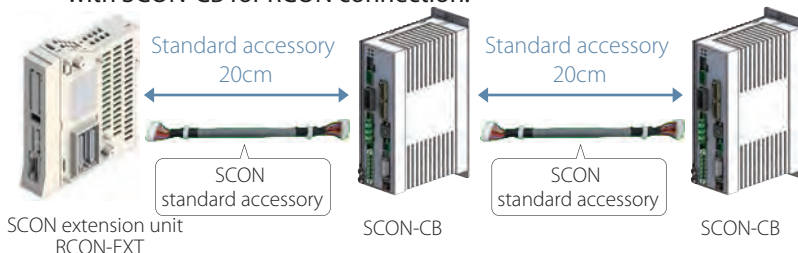

Additional information

If the connection cable is too short, purchase a separate cable to make the connection.

Model: CB-RE-CTL□□□□

See P. 85



x Required number of units

Caution: The maximum cable length between devices is 3m.
The total cable length is 10m (max.).

Step 10 Calculation of various unit control power capacities (CP)

Make sure that the total control power capacity of the units and EleCylinder connected to RCON is as follows.

Item	Average current
Control power (CP)	9.0A or less

How to check

Add up while checking the "Control power capacity list" below.

Control power capacity list

Item	Specifications		Power capacity	<Selection example>	
Control power capacity (per unit)	Master unit (including terminal unit)	Gateway unit Without Ethernet	0.8A		
		Gateway unit With Ethernet	1.0A		
	24V driver unit (common for all types)	Without brake		0.2A	x 4 units x 1 unit
		With brake (1-axis specification)		0.4A	
		With brake (2-axis specification)		0.6A	
	230V driver unit	Without brake		0.2A	x 1 unit x 1 unit
		With brake		0.5A	
	Extension unit			0.1A	x 1 unit
	Simple absolute unit (common to all types)			0.2A	x 2 units
	EC connection unit (per unit)			0.1A	x 1 unit
	24V specification EleCylinder (per axis)	Without brake		0.3 A	x 1 axis
		With brake		0.5 A	
	230V specification EleCylinder (per axis)	Without brake		0.32 A	
With brake		EC-S10□, EC-S10X□	0.54 A		
With brake		EC-S13□, EC-S13X□ EC-S15□, EC-S15X□	1.2A		

* For selection of the unit, power capacity of the master unit is not included for calculation. However, for 24V power selection, include the master unit power capacity.

<Selection example>

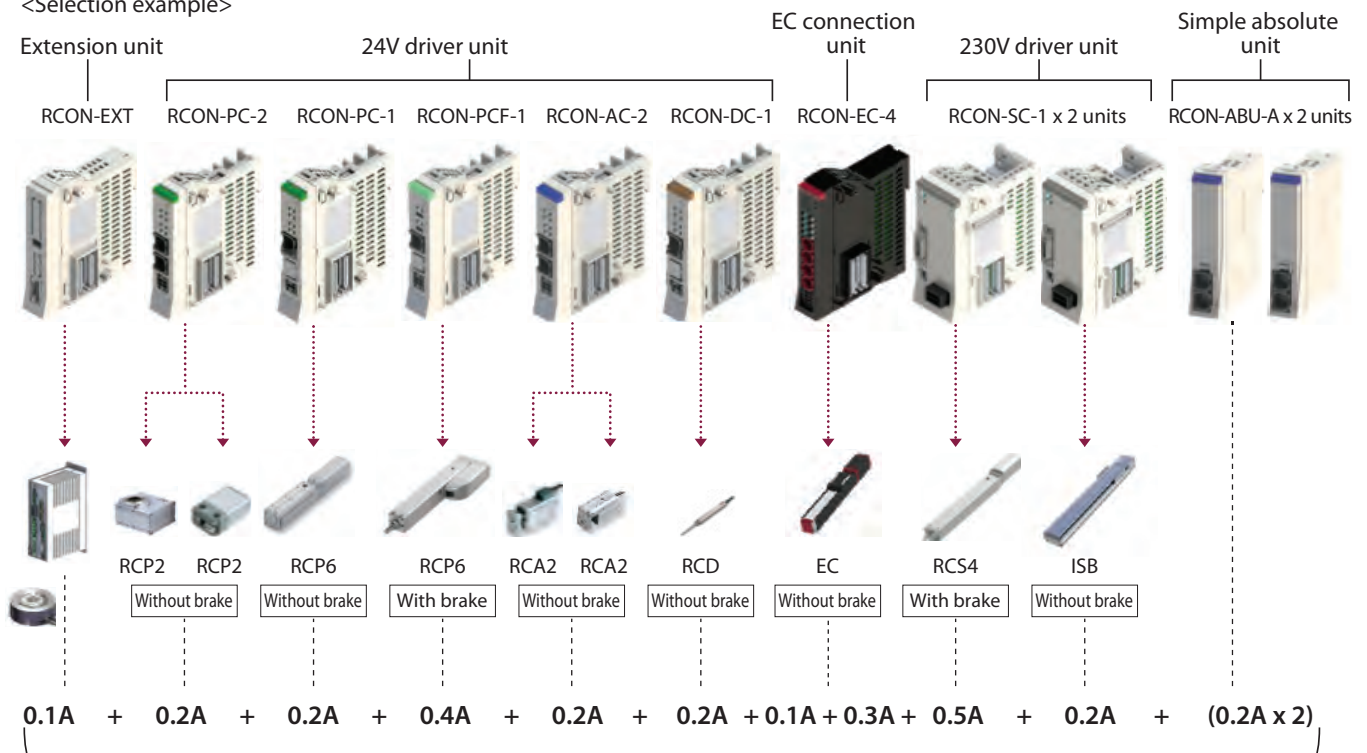

Total **2.8A** < 9.0A

OK

(The total was confirmed to be 9.0A or less. If the value is larger than 9.0A, another gateway unit is required.)

Step 11 Calculation of various unit motor power capacities (MP)

Make sure that the total motor power capacity of the units connected to RCON is as follows.

Item	Average current
Motor power (MP)	37.5A or less

How to check

Add up while checking the "Motor power capacity list" below.
If the maximum current is listed, add the maximum current.
If not, add the rated current.

● 24V driver unit

Item	Actuator/driver unit			Rated current	Max. current		<Selection example>	
	Series	Motor type			When energy-saving is set			
Motor power capacity (per 1-axis actuator)	Pulse motor /RCON-PC	RCP2	20P/20SP/28P	Without PowerCon	0.8A	-	-	x 2 axes
		RCP3	28P/35P/42P/56P		1.9A	-	-	
		RCP4	28P/35P/42P/42SP/56P	Without PowerCon	1.9A	-	-	x 1 axis
		RCP5 RCP6		With PowerCon	2.3A	-	3.9A	
	Pulse motor /RCON-PCF	RCP2 RCP4 RCP5 RCP6	56SP/60P/86P	Without PowerCon	5.7A	-	-	x 1 axis
		AC servo motor /RCON-AC	RCA RCA2	5W	Standard / Hi-accel./decel.	1.0A	-	3.3A
	10W			Standard / Hi-accel./decel. / Energy-saving	1.3A	2.5A	4.4A	
	20W				1.3A	2.5A	4.4A	
	20W(20S)				1.7A	3.4A	5.1A	
	30W			1.3A	2.2A	4.0A		
-	-	-	-	-	-			
DC brush-less motor /RCON-DC	RCD	3W	Standard	0.7A	-	1.5A	x 1 axis	

* Applicable models: RCP2-RA3, RCP2-RGD3

● EC connection unit

Item	Actuator/EC connection unit			Power source current			<Selection example>	
	Series	Motor type	Type	Energy-saving disabled		Energy-saving enabled		
				Power source current	Maximum			
Motor power capacity (per 1-axis actuator)	24V pulse motor	EC	35P/42P/56P	Other than the below	2.3A	3.9A	1.9A	x 1 axis
			28P	S3□/RR3□	-	-	1.9A	
				RP4/GS4/GW4/TC4/TW4/RTC9/GRB10/GRB13	-	-	1.7A	
			20P	GRB8	-	-	0.7A	

<Selection example>

24V driver unit

EC connection unit

Actuator	RCON-PC-2		RCON-PC-1		RCON-PCF-1		RCON-AC-2		RCON-DC-1	RCON-EC-4
Series	RCP2	RCP2	RCP6	RCP6	RCA2	RCA2	RCD	EC		
Motor type	28P	20P	35P	60P	10W	20W	3W	42P		
$0.8A + 0.8A + 3.9A + 5.7A + 4.4A + 4.4A + 1.5A + 3.9A = 25.4A < 37.5A$										
Total 25.4A < 37.5A <div style="border: 1px solid black; padding: 5px; display: inline-block;">OK</div>										

(The total was confirmed to be 37.5A or less. If the value is larger than 37.5A, another gateway unit is required.)

Step 12 230V motor power limiting

Make sure that the total motor wattage (W) of the actuators connected to RCON-SC is as follows.

*Some limitations apply. See "Actuators that cannot connect to R-units" (P. 46) for details.

Connected power	Total max. output of connected axes
Single-phase 230VAC (*)	1600W

(*) Max. output of connected axes is 2400W, if three-phase 230VAC is connected.

How to check

Confirm the motor wattage (W) in the actuator specifications. For some models, it is necessary to calculate the power capacity using the "motor wattage for calculation." See P.52 for details.

<Selection example>

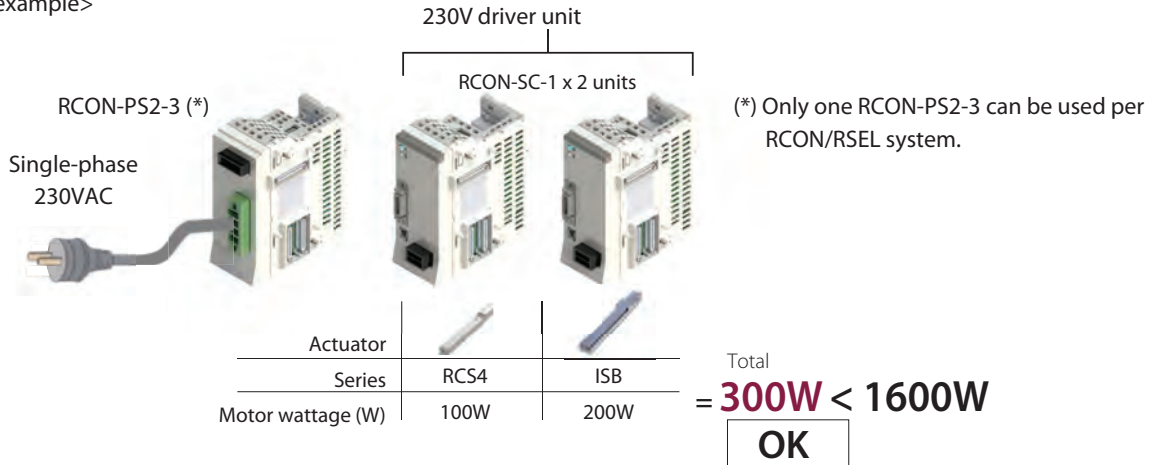

Step 13 Fan unit selection

If the controller installation environment may exceed 40°C, a fan unit will be required. (Up to 55°C.) (*)

(1) 24V driver unit fan unit

The number of fan units is the total number of driver units divided by 2.

If the total number of 24V driver units is an odd number, add 1 to the total number and divide it by 2.

When ordering, be sure to specify the gateway unit model.

<Selection example>

24V driver units (5 units + 1) : 2 = 3 units

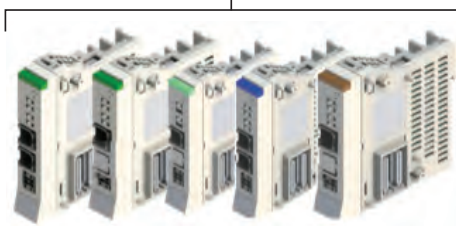

Selection **8**

Note: The ambient operating temperature of the simple absolute unit is within the range of 0~40°C even when a fan unit is installed.

(*) The operating temperature of the gateway unit/driver unit is within the range of 0~55°C. However, temperature derating may occur depending on whether a fan unit is installed. Operation without derating is possible without a fan unit at 0 ~ 40°C; however, at 40 ~ 55°C, actuator operating duty must be reduced by 20% every 5°C.

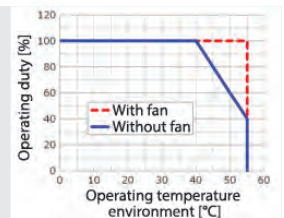

(2) 230V driver unit and power supply unit fan units

A single fan unit is always included with each installation unit. (There is no need to specify the model.)

<Selection example>

230V driver units x 2 units

RCON-FUH x 2 units
(supplied)

230V power supply unit RCON-FU x 1 unit
(supplied)



Step 14 Terminal units

Select the terminal unit to connect based on the unit connected to the left of the terminal unit.
(Units are designed to prevent incorrect connections. Confirm the model first before installing a unit.)

Unit connected to left	Terminal unit single product model number	Supplied unit and cautions when ordering
RCON-SC	RCON-GW-TRS	Supplied with 230V power supply unit (select "TRN (no terminal unit)" for the gateway unit option)
Other than RCON-SC	RCON-GW-TR	Supplied with gateway unit

← Selection 9

Step 15 Unit models to be ordered

Order using the model name for each unit.

<Selection example>

Order model (x number of units)	Name/specification
RCON-GW-CC-FU3-TRN	Gateway unit (with 3 fans, without terminal unit)
RCON-EXT	SCON expansion unit
RCON-PC-2	24V driver unit (RCP Series connection, 2-axis specification)
RCON-PC-1	24V driver unit (RCP Series connection, 1-axis specification)
RCON-PCF-1	24V driver unit (RCP Series connection, 1-axis specification, for high thrust)
RCON-AC-2	24V driver unit (RCA Series connection, 2-axis specification)
RCON-DC-1	24V driver unit (RCD Series connection, 1-axis specification)
RCON-ABU-A x 2 units	Simple absolute unit (for RCA Series connection)
RCON-EC-4	EC connection unit
RCON-PS2-3	230V power supply unit
RCON-SC-1 x 2 units	230V driver unit
SCON-***-RC	RCON connection specification SCON controller *Select the model to order based on the actuator to connect.

1 8
6
2
2
2
2
2
3
4
5 9
5
7

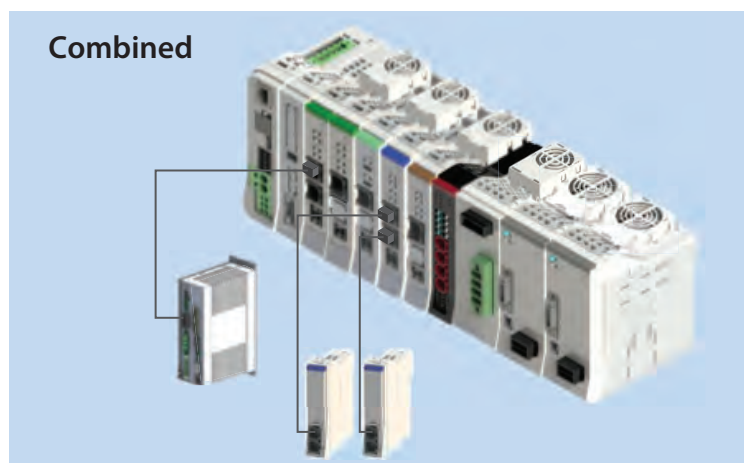
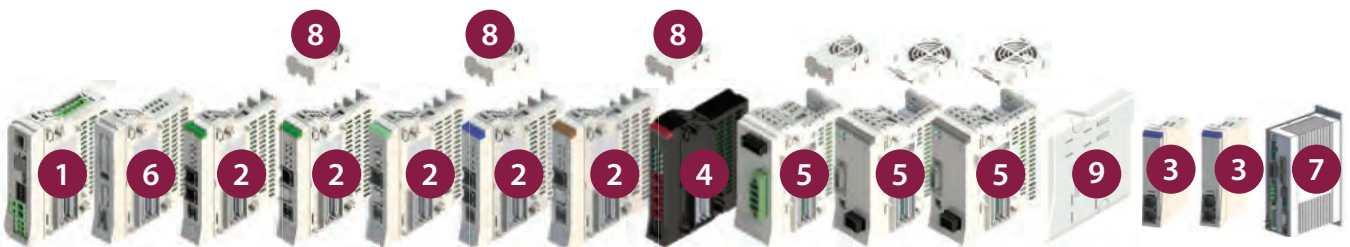

Selection Method

Step 1 Select the actuator to connect. (Up to 16 axes)

(Note) See P. 46 for non-connectable actuators and limitations on connection.

* Make sure to select optional "ACR" as the EleCylinder model.

<Selection example>

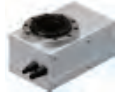

RCS2 Series



RCA2 Series



RCP6 Series



WU Series



RCS4 Series



IS(P)B Series



EC Series

Step 2 SEL unit selection

Select the SEL unit model from the following I/O types.

I/O type		SEL unit model
Not used		RSEL-G-E
PIO specification	NPN	RSEL-G-NP
	PNP	RSEL-G-PN
	(Bifurcated connector supplied)	RSEL-G-CC RSEL-G-CC2
		RSEL-G-CIE
	(Bifurcated connector supplied)	RSEL-G-DV RSEL-G-DV2
		RSEL-G-EC
		RSEL-G-EP
		RSEL-G-PR
		RSEL-G-PRT

← Selection 1

Caution

Only one SEL unit can be connected per system. Split this among two or more units to connect more than the maximum connectable axes or if the power capacity is exceeded.

Example: When connecting 14 axes

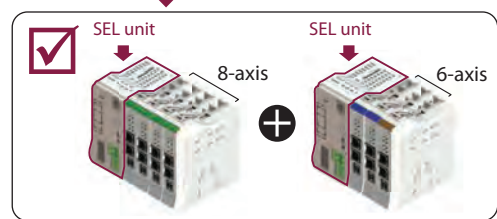
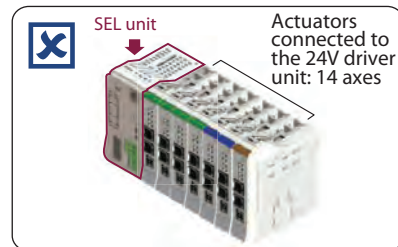

Maximum connectable axes to the driver unit and EC connection unit.

* 24V/230V driver unit: up to 8 axes

* EC connection unit: up to 16 axes







Step 3 Classify actuator types into three categories.

*See P. 46 for actuators that cannot be connected.

Actuator type	Selected actuator
Models with 24V motors RCP2/3/4/5/6 Series RCA/2 Series RCD Series WU Series	<Selection example> RCA2 RCP6 WU
Models with 230V motors RCS2/3/4 Series IS(D)B Series SSPA Series NS(A) Series DD(A) Series	<Selection example> RCS2 RCS4 ISB ISPB
EleCylinder (equipped with a 24 V motor) EC Series	<Selection example> EC

Step 4 24V driver unit selection (models with 24V motors)

Select the driver unit model and number of units according to the series name and motor type of the actuator.

Actuator		24V driver unit			<Selection example>	
Series	Motor type	External view	Number of axes connected to actuator	Model	Classification	Required units
RCP2 RCP3 RCP4 RCP5 RCP6 WU	20P, 28P 35P, 42P 56P		2-axis specification	RCON-PC-2	 WU-S	1 ← Selection 2
			1-axis specification	RCON-PC-1	 RCP6-RTFML	1 ← Selection 2
	High thrust motor 56SP, 60P 86P		1-axis specification	RCON-PCF-1	-	-
RCA RCA2	2 5 10 20, 20S 30		2-axis specification	RCON-AC-2	-	-
			1-axis specification	RCON-AC-1	 RCA2-GS3NA	1 ← Selection 2
RCD	3D		2-axis specification	RCON-DC-2	-	-
			1-axis specification	RCON-DC-1	-	-

Step 5 Simple absolute unit selection

For actuators which are to use the simple absolute specification, select a number of simple absolute units (RCON-ABU-A/P) according to the number of axes.

*Connect to the driver unit with a cable (CB-ADPC-MPA005).

The cable is supplied with the simple absolute unit.

Note: The ambient operating temperature of the simple absolute unit is within the range of 0~40°C.

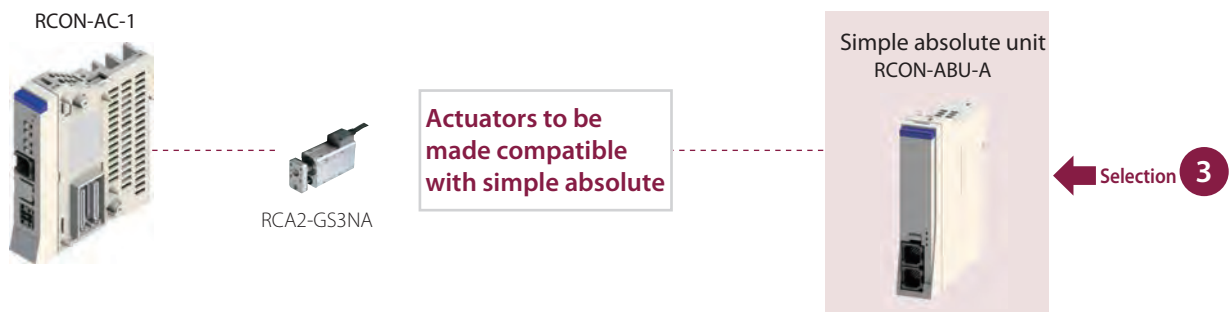

<Selection example>

This is an example in which an RCA2 Series actuator is selected for simple absolute specification.





Step 6 Selection of EC connection unit (EleCylinder model)

For connection of the EC Series, select the necessary number of connection units according to the number of connected EC units.

Actuator		EC connection unit			<Selection example>	
Series	Motor type	External view	Number of axes connected to actuator	Model	Classification	Required units
EC	28P, 35P 42P, 56P		4-axis specification	RCON-EC-4	 EC-RR6  EC-GRB10	1 ← Selection 4





Step 7 Classify models with 230V motors into two categories.

Models are classified as axes connected to a 230V driver unit and axes connected to an extension unit.

Connection unit	Actuator specifications	Selected actuator
230V driver unit	Specification that meets all conditions below (Motor wattage [W]) 60W~750W (Encoder type) Incremental Battery-less Absolute	 RCS4-WRA16R-WA-400  IS(P)B-LXL-WA-400
Extension unit	Specification other than above	 RCS2-RTC8L-I-20 *This is because the 20W specification cannot be connected to RCON-SC.



Step 8 230V driver unit selection

Select one 230V power supply unit and a number of driver units according to the actuators to connect.



Unit name	External view	Number of axes connected to actuator	Model	<Selection example>	
				Classification	Required units
230V power supply unit		-	RCON-PS2-3	-	1 ← Selection 5
230V driver unit		1-axis specification	RCON-SC-1	 RCS4  ISB	3 ← Selection 5

Step 9 Extension unit selection

(1) Select only one of two models listed below if there are any 230VAC servo actuators connected with an extension unit. (Those two different type can not be used in one system.)

Unit name	External view	Number of axes connected to actuator	Model	<Selection example>	
				Classification	Required units
SCON extension unit		Max. 8 axes	RCON-EXT	-	-
PIO/SIO/SCON extension unit		Max. 8 axes	RCON-EXT-NP/PN	 RCS2-RTC8L-I-20	1 ← Selection 6

(2) Select a number of controllers (SCON) to connect through the expansion unit according to the number of connected actuators. *A number of SCONs must be purchased according to the number of connected axes. (Max. number of connections: 8 axes.)

Controller	External view	Number of axes connected to actuator	I/O type	<Selection example>	
				Classification	Required units
SCON-CB/CGB		1-axis specification	SCON-**-RC-*	 RCS2-RTC8L-I-20	1 ← Selection 7

● Example of connecting an SCON connection expansion unit and SCON-CB

One cable (CB-RE-CTL002) is supplied as standard with SCON-CB for RSEL connection.

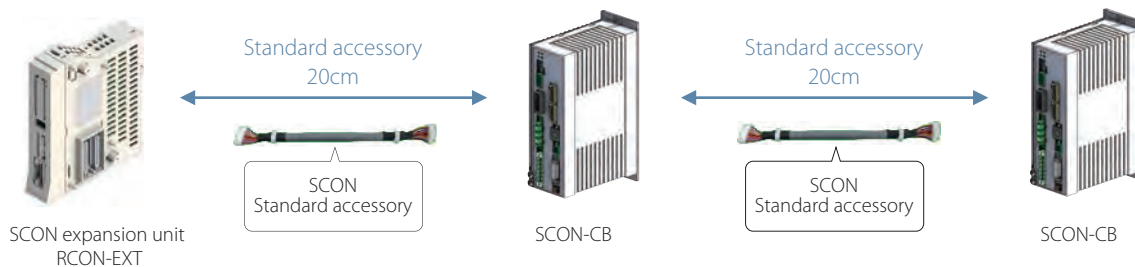

Additional information

If the connection cable is too short, purchase a separate cable to make the connection.

Model: CB-RE-CTL□□□

See P. 85



x Required number of units

Caution: The maximum cable length between devices is 3m. The total cable length is 10m (max.).

(3) When selecting a PIO unit

A PIO unit can be connected to increase the number of PIO IO points. (The maximum number of input points is 144 and maximum number of output points is 144.)

There are 16 input points and 16 output points for a single unit, with a maximum of 8 units connected. (If connecting a PIO/SIO/SCON expansion unit, the maximum will be 7 units.)

If the number of input points or output points is evenly divisible by 16, order that number of PIO units.

If the number is not evenly divisible, order a number of PIO expansion units equal to the number rounded up to the next whole number.

<Selection example>

In this example, the number of PNP specification IO points is increased by 24 input points and 20 output points.

24 input points : 16 = 1.5



2 units

PIO unit [RCON-PN]



← Selection **8**

Step 10 Calculation of various unit control power capacities (CP)

Make sure that the total control power capacity of the units connected to RSEL is as follows.

Item	Average current
Control power (CP)	9.0A or less

How to check

Add up while checking the "Control power capacity list" below.

Control power capacity list

Item	Specification	Power capacity	<Selection example>	
Control power capacity (per unit)	Master unit (including terminal unit)	SEL unit	1.2A	
	24V driver unit (common for all types)	Without brake	0.2A	x 1 unit x 1 unit x 1 unit
		With brake (1-axis specification)	0.4A	
		With brake (2-axis specification)	0.6A	
	230V driver unit	Without brake	0.2A	x 3 units x 3 units x 1 unit x 1 unit x 1 unit
		With brake	0.5A	
	Extension unit (common for all types)		0.1A	
	Simple absolute unit (common to all types)		0.2A	
	EC connection unit (per unit)		0.1A	
	24V specification EleCylinder (per axis)	Without brake	0.3A	x 1 unit x 1 unit
		With brake	0.5A	
	230V specification EleCylinder (per axis)	Without brake	0.32A	x 1 unit
With brake		EC-S10□ /S10X□	0.54A	
		EC-S13□ /S13X□ EC-S15□ /S15X□	1.2A	

* For selection of the unit, power capacity of the master unit is not included in calculation. However, for 24V power selection, include the master unit power capacity.

<Selection example>

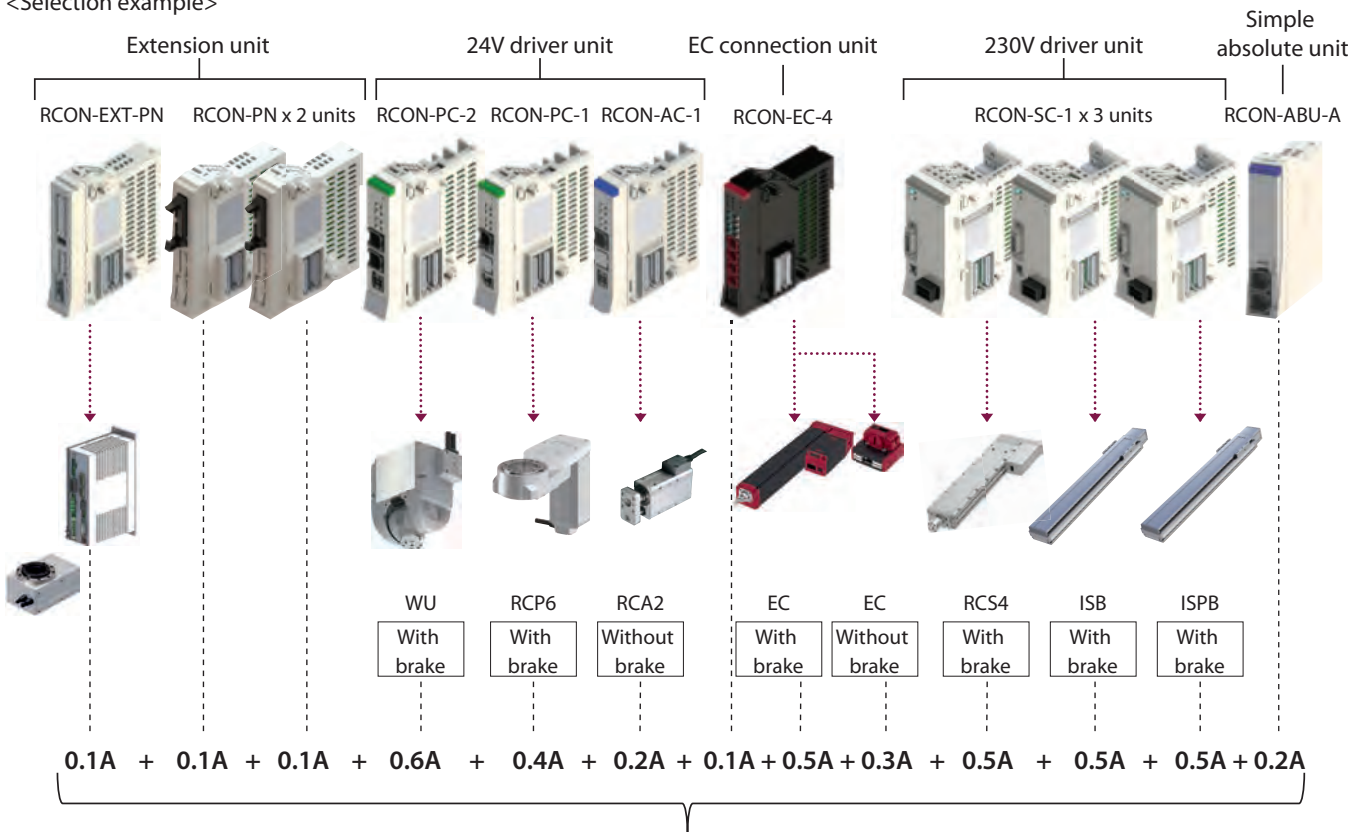

(The total was confirmed to be 9.0A or less. If the value is larger than 9.0A, another SEL unit is required.)

Step 11 Calculation of various unit motor power capacities (MP)

Make sure that the total motor power capacity of the units connected to RSEL is as follows.

Item	Average current
Motor power (MP)	37.5A or less

How to check

Add up while checking the "Motor power capacity list" below.
If the maximum current is listed, add the maximum current.
If not, add the rated current.

● 24V driver unit

Item	Actuator/driver unit			Rated current	Max. current		<Selection example>	
	Series	Motor type			When energy-saving is set			
Motor power capacity (per 1-axis actuator)	Pulse motor /RCON-PC	RCP2	20P/20SP/28P	Without PowerCon	0.8A	-	-	x 3 axes
		RCP3	28P /35P/42P/56P		1.9A	-	-	
		RCP4 RCP5 RCP6 WU	28P/35P/42P/ 42SP/56P	Without PowerCon	1.9A	-	-	
		With PowerCon	2.3A		-	3.9A		
	Pulse motor /RCON-PCF	RCP2 RCP4 RCP5 RCP6	56SP/60P/86P	Without PowerCon	5.7A	-	-	
	AC servo motor /RCON-AC	RCA RCA2	5W	Standard / Hi-accel./decel.	1.0A	-	3.3A	x 1 axis
			10W		1.3A	2.5A	4.4A	
			20W	Standard / High accel/decel / Energy saving	1.3A	2.5A	4.4A	
			20W(20S)		1.7A	3.4A	5.1A	
	30W	1.3A	2.2A	4.0A				
DC brush-less motor /RCON-DC	RCD	3W	Standard	0.7A	-	1.5A		

* Applicable models: RCP2-RA3, RCP2-RGD3

● EC connection unit

Item	Actuator / connection unit				Power source current			<Selection example>
	Series	Motor type	Type	Energy-saving disabled		Energy-saving enabled		
				Power source current	Maximum			
Motor power capacity (per 1-axis actuator)	24V pulse motor	EC	35P/42P/56P	Other than specified below	2.3A	3.9A	1.9A	x 1 axis
			28P	S3□/RR3□	-	-	1.9A	
				RP4/GS4/GW4/TG4/TW4/ RTC9/GRB10/GRB13	-	-	1.7A	x 1 axis
20P	GRB8	-	-	0.7A				

<Selection example>

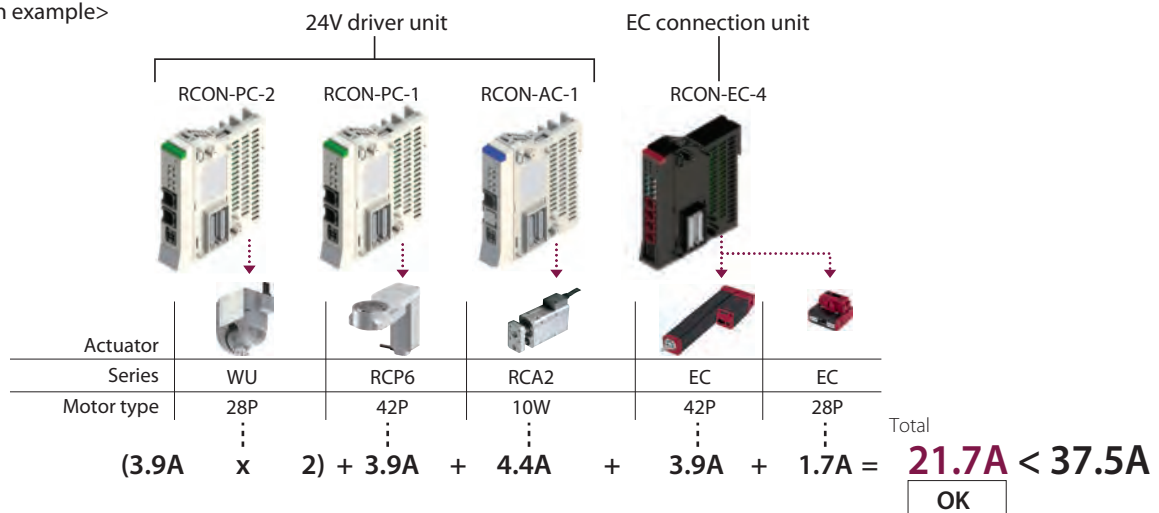

(The total was confirmed to be 37.5A or less. If the value is larger than 37.5A, another SEL unit is required.)

Step 12 230V motor power limiting

Make sure that the total motor wattage (W) of the actuators connected to RCON-SC is as follows.

*Some limitations apply. See "Actuators that cannot connect to R-units" (P. 46) for details.

Connected power	Total max. output of connected axes
Single-phase 230VAC (*)	1600W

(*) Max. output of connected axes is 2400W, if three-phase 230VAC is connected.

How to check

Confirm the motor wattage (W) in the actuator specifications. For some models, it is necessary to calculate the power capacity using the "motor wattage for calculation." See P.52 for details.

<Selection example>

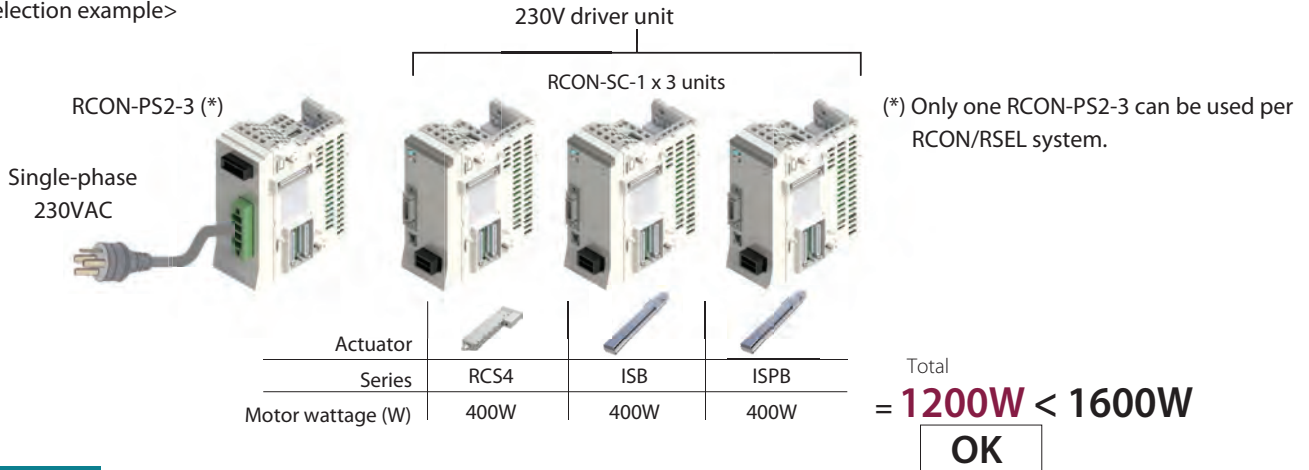

Step 13 Fan unit selection

If the controller installation environment may exceed 40°C, a fan unit will be required. (Up to 55°C.) (*)

(1) SEL unit and 24V driver unit fan units

A single fan unit can be installed to a SEL unit.

The number of fan units for 24V driver units is the total number of 24V driver units divided by 2.

If the total number of 24V driver units is an odd number, add 1 to the total number and divide it by 2.

When ordering, be sure to specify the number of units for the SEL unit model.

<Selection example>

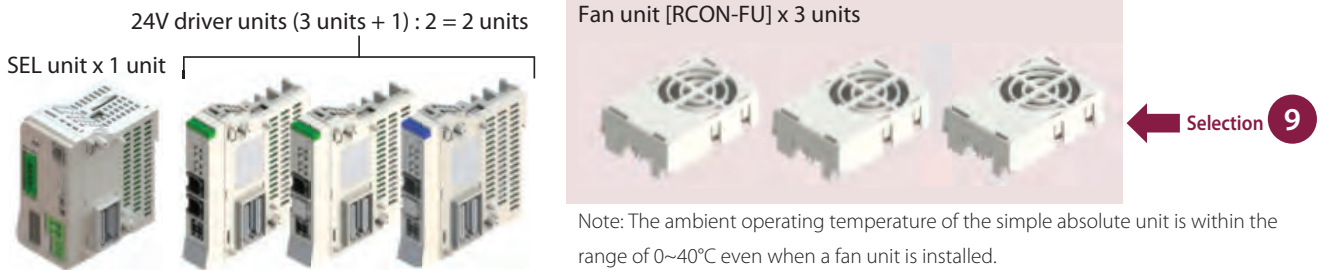

(*) The operating temperature of the gateway unit/driver unit is within the range of 0~55°C.

However, temperature derating may occur depending on whether a fan unit is installed.

Operation without derating is possible without a fan unit at 0 to 40°C;

however, at 40 to 55°C, actuator operating duty must be reduced by 20% every 5°C.

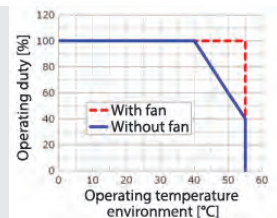

(2) 230V driver unit and 230V power supply unit fan units

A single fan unit is always included with each installation unit. (There is no need to specify the model.)

<Selection example>



Step 14 Terminal units

Select the terminal unit to connect based on the unit connected to the left of the terminal unit.
(Units are designed to prevent incorrect connections. Confirm the model first before installing a unit.)

Unit connected to left	Terminal unit single product model number	Supplied unit and cautions when ordering
RCON-SC	RCON-GW-TRS	Supplied with 230V power supply unit (select "TRN (no terminal unit)" for the SEL unit option).
Other than RCON-SC	RCON-GW-TR	Supplied with SEL unit.

← Selection 10

Step 15 Unit models to be ordered

Order using the model name for each unit.

<Selection example>

Order model (x number of units)	Name/specification
RSEL-G-DV2-FU3-TRN	SEL unit (with 3 fans, without terminal unit)
RCON-EXT-NP	PIO/SIO/SCON extension unit
RCON-NP x 2 units	PIO unit
RCON-PC-2	24V driver unit (RCP Series connection, 2-axis specification)
RCON-PC-1	24V driver unit (RCP Series connection, 1-axis specification)
RCON-AC-1	24V driver unit (RCA Series connection, 1-axis specification)
RCON-ABU-A	Simple absolute unit (for RCA Series connection)
RCON-EC-4	EC connection unit
RCON-PS2-3	230V power supply unit
RCON-SC-1 x 3 units	230V driver unit
SCON-***-RC	RCON connection specification SCON controller *Select the model to order based on the actuator to connect.

1 9

6

8

2

2

2

3

4

5

10

5

7

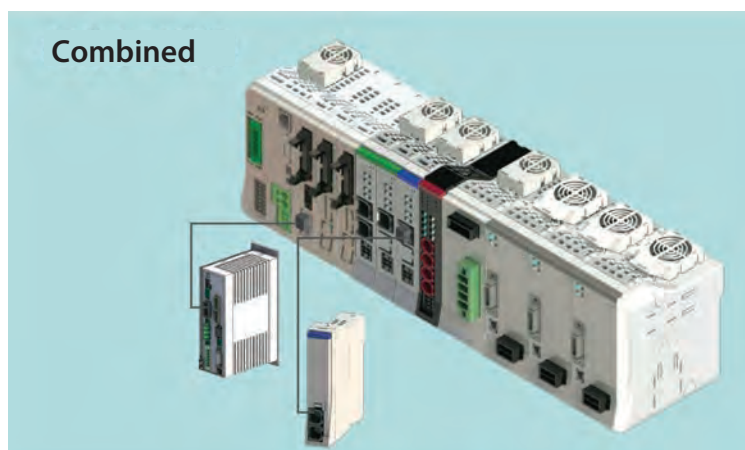

Step 1 Select the EleCylinder with ACR option to connect. (Up to 16 axes.)

<Selection example>



* Only EC with ACR option can be connected to RCON-EC unit.

Step 2 EC gateway unit selection

Select the EC gateway unit model from the network type.

Network type	Gateway unit model
	REC-GW-CC
	REC-GW-CIE
	REC-GW-DV
	REC-GW-EC
	REC-GW-EP
	REC-GW-PR
	REC-GW-PRT

<Selection example>

← Selection 1

Caution Only one EC gateway unit can be connected per system. Split this among two or more units to connect 17 or more axes or if the power capacity is exceeded.

Example: When connecting 20 axes

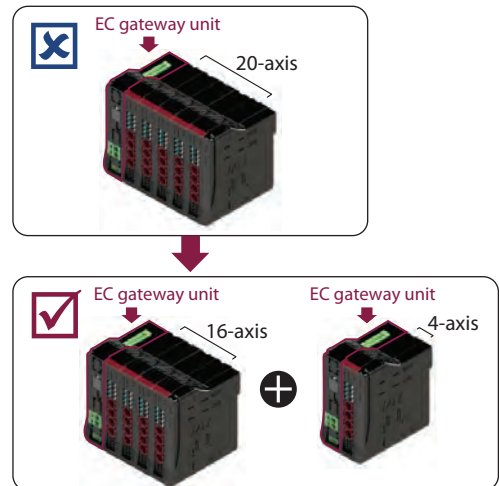

Step 3 EC connection unit selection

Up to 4 axes of EleCylinder can be connected to one EC connection unit.

Select the required number of EC connection units based on the number of units for connecting EleCylinder.

Actuator	EC connection unit			<Selection example>	
	External view	Number of axes connected to actuator	Model	Classification	Required units
EC		4-axis specification	RCON-EC-4		2 ← Selection 2

Step 4 Calculation of control power capacity (CP)

Confirm that the total control power capacity of each unit connected to REC and EleCylinder is less than the value specified below.

Item	Average current
Control power (CP)	Less than 9.0A

How to check

Add up referring to the "Control power capacity table" below.

Item	Specification	Power source current		
Control power capacity	Master unit	0.8A		
	EC connection unit	0.1A		
	24V specification EleCylinder (per unit)	Without brake	0.3A	
		With brake	0.5A	
	230V specification EleCylinder (per axis)	Without brake	0.32A	
		With brake	EC-S10□/S10X□	0.54A
			EC-S13□/S13X□	1.2A
EC-S15□/S15X□				

x 2 axes
x 4 axes
x 2 axes

x 1 axis

* Power capacity of the master unit is not included in calculation.

<Selection example>

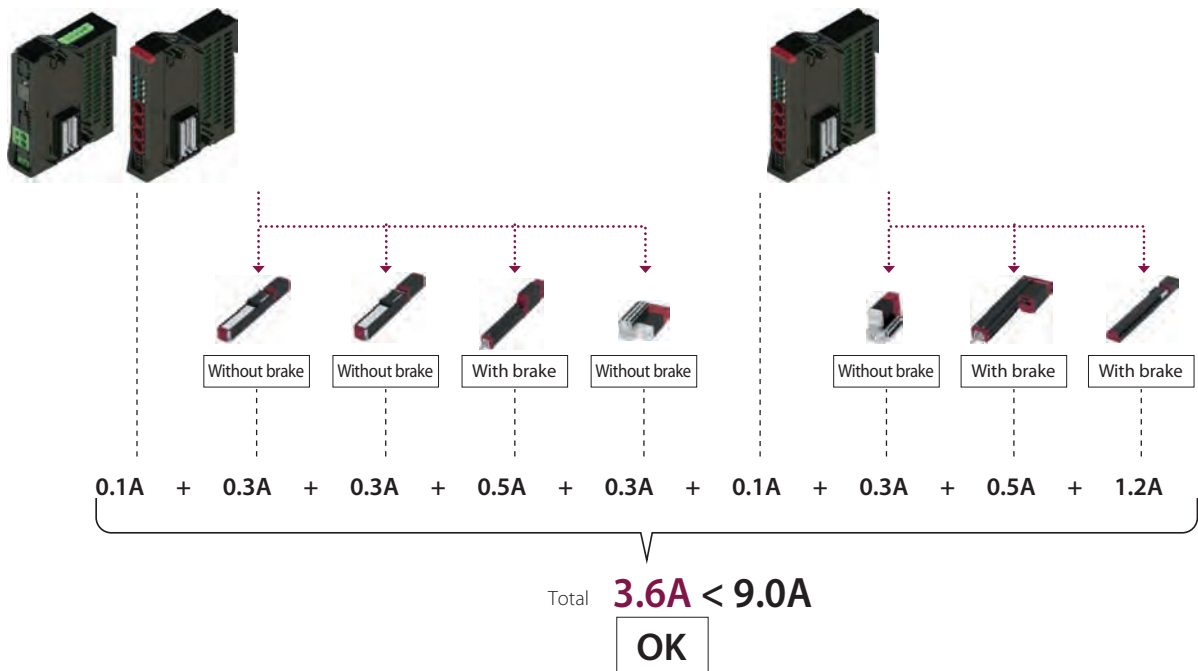

(It is confirmed that the current is less than 9.0A. If it is greater than 0.9A, another gateway unit is needed.)

Step 5 Calculation of motor power capacity (MP)

Make sure that the total motor power capacity of the units connected to REC is as follows.

Item	Average current
Motor power (MP)	37.5A or less

How to check

Add up while checking the "Motor power capacity list" below.
If the maximum current is listed, add the maximum current.
If not, add the rated current.

Motor power capacity list

Item	Actuator / connection unit			Power source current			
	Series	Motor type	Type	Energy-saving disabled	Energy-saving enabled		
				Rate current	Maximum		
Motor power capacity (per 1-axis actuator)	24V pulse motor	EC	35P/42P/56P	Other than the below	2.3A	3.9A	1.9A
			28P	S3□/RR3□	-	-	1.9A
				RP4/GS4/GW4/TC4/TW4/RTC9/GRB10/GRB13	-	-	1.7A
				20P	GRB8	-	-

<Selection example>

x 3 axes
x 1 axis
x 2 axes

<Selection example>

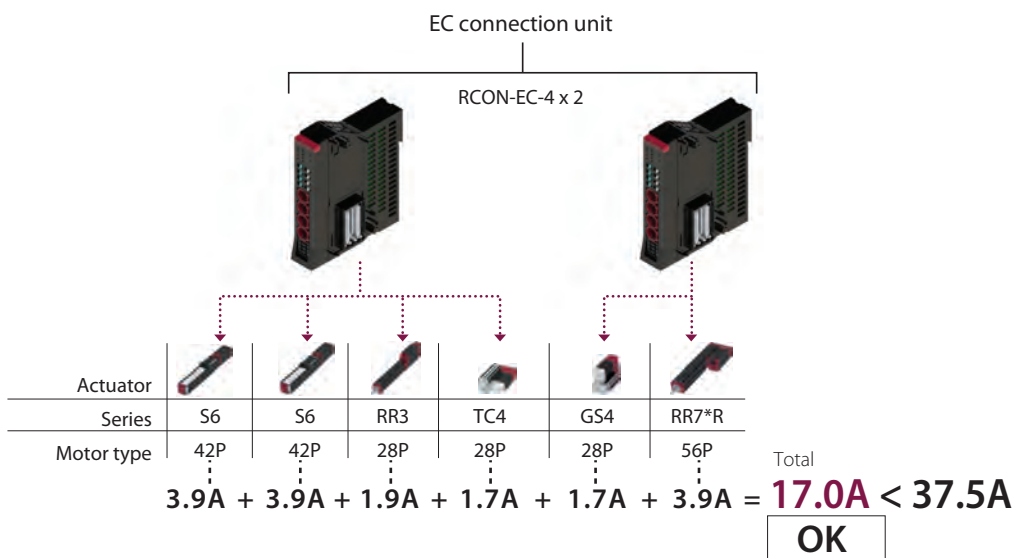

(The total was confirmed to be 37.5A or less. If the value is larger than 37.5A, another EC gateway unit is required.)

Step 6 Selection of 230V specification motor power

When connecting a 230V specification EleCylinder, determine the number of power supply units for DC motors according to the total motor wattage.

DC power source for driving motors

Connecting power	Max. connectable axes (per power supply unit)	Max. connecting motor wattage
PSA-200-2 (AC230V)	6 axes	1600W

How to check

Confirm the motor wattage from the actuator specification.

<Selection example>



DC power source (AC230V)

Series	EC-S13
Motor wattage	200W

Total = **200W** < 1600W (one unit)

OK

Step 7 Unit models to be ordered

Order using the model name for each unit.

<Selection example>

Order model (x number of units)	Name/specification
REC-GW-CC	EC gateway unit (with terminal unit)
RCON-EC-4 x 2 units	EC connection unit

1

2



Combined



RCON

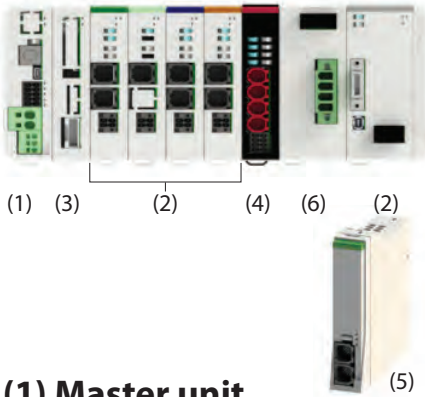

RSEL

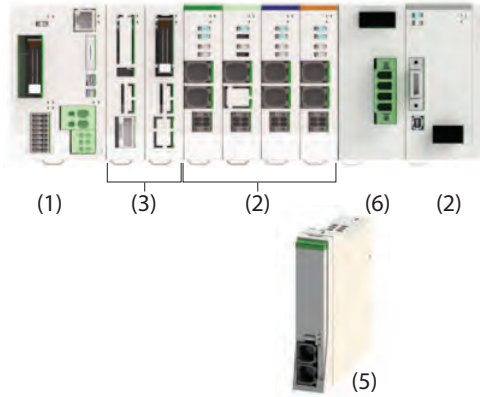

REC

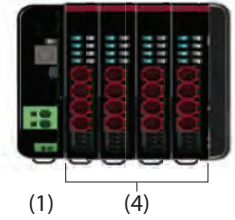

(1) Master unit

RCON - [] - [] - []

Series Type I/O type Options

GW	Standard type
GWG	Safety category spec type

CC	CC-Link connection specification
CIE	CC-Link IE Field connection specification
DV	DeviceNet connection specification
EC/ECM	EtherCAT/ EtherCAT motion connection specification
EP	EtherNet/IP connection specification
PR	PROFIBUS-DP connection specification
PRT	PROFINET IO connection specification

ET	Ethernet-equipped
FU□	Fan unit mounting (□: Specify the number of units, 1 ~ 8)
TRN	Without terminal unit

*. For fan units, this is the number connected to the 24V driver unit.
 · A terminal unit is required during operation.
 However, when connecting/ordering an RCON-SC, connect the terminal unit supplied with the 230V power supply unit.

RSEL - **G** - [] - [] - []

Series Type I/O type I/O Cable Length Options

E	Not used
NP	PIO specification (NPN16/16)
PN	PIO specification (PNP16/16)
CC	CC-Link connection specification
CC2	CC-Link connection specification (bifurcated connector supplied)
CIE	CC-Link IE Field connection specification
DV	DeviceNet connection specification
DV2	DeviceNet connection specification (bifurcated connector supplied)
EC	EtherCAT connection specification
EP	EtherNet/IP connection specification
PR	PROFIBUS-DP connection specification
PRT	PROFINET IO connection specification

0	Without cable
2	2m (Standard)
3	3m
5	5m

*If a specification other than PIO was selected for the I/O type, this will be "0 (without cable)".

FU□	Fan unit mounting (□: Specify the number of units, 1 ~ 5)
TRN	Without terminal unit

*. For fan units, this is the number connected to the master unit and 24V driver unit.
 · A terminal unit is required during operation.
 However, when connecting/ordering an RCON-SC, connect the terminal unit supplied with the 230V power supply unit.

REC - **GW** - [] - []

Series Type I/O type Options

CC	CC-Link connection specification
CIE	CC-Link IE Field connection specification
DV	DeviceNet connection specification
EC	EtherCAT connection specification
EP	EtherNet/IP connection specification
PR	PROFIBUS-DP connection specification
PRT	PROFINET IO connection specification

TRN	Without terminal unit
-----	-----------------------

* A terminal unit is required during operation.

(2) Driver unit

RCON - [] - []
 Series Type Number of Axes

PC	Pulse motor
PCF	High thrust pulse motor
AC	AC servo motor
DC	DC brush-less motor
SC	230V AC servo motor

1	1-axis specification
2	2-axis specification

*Type: Only 1-axis can be selected for PCF and SC.

24V specification

Type: PC 1.2A motor 1 axis 2 axes	20P 20SP 28P 35P 42P 42SP 56P	20□ pulse motor 20□ pulse motor (For RA2AC/RA2BC) 28□ pulse motor 35□ pulse motor 42□ pulse motor 42□ pulse motor (For RCP4-RA5C) 56□ pulse motor
Type: PCF 4A motor 1 axis	56SP 60P 86P	56□ high thrust pulse motor 60□ high thrust pulse motor 86□ high thrust pulse motor

Type: AC 2-30W motor 1 axis 2 axes	2 5 10 20 20S 30	2W servo motor 5W servo motor 10W servo motor 20W servo motor 20W servo motor (For RCA2-SA4/RCA-RA3) 30W servo motor
---	---------------------------------	---

Type: DC 3D motor 1 axis 2 axes	3D	2.5W DC brush-less motor
--	----	--------------------------

230V specification

Type: SC 60-750W motor 1 axis	30R 60 100 150 200 200S 400 600 750	30W (for RS) 60W servo motor 100W servo motor 150W servo motor 200W servo motor 200W servo motor (for DD) 400W servo motor 600W servo motor 750W servo motor
-------------------------------------	---	--

(3) Extension unit

RCON - [] - []
 Series Extension I/O Cable Length

EXT	SCON extension
EXT-NP	PIO/SIO/SCON extension (NPN specification)
EXT-PN	PIO/SIO/SCON extension (PNP specification)
NP	PIO (NPN specification)
PN	PIO (PNP specification)

0	No cable
2	2m (Standard)
3	3m
5	5m

*No I/O cable length selection required if SCON extension (EXT) is selected.

(4) EC connection unit

RCON - EC - 4
 Series Type Number of Axes

* EC without ACR option cannot be connected to RCON-EC even though the cable for RCON-EC connection is used.

(5) Simple absolute unit

RCON - ABU - []
 Series Absolute Unit Type

P	Pulse motor
A	AC servo motor

(6) 230V power supply unit

RCON - PS2 - 3 - []
 Series Type Power supply voltage Options

3	Three-phase/single-phase 230V
---	-------------------------------

TRN	Without terminal unit
-----	-----------------------







Only one RCON-PS2-3 can be used per RCON/RSEL.







(7) SCON controller (RCON-EXT connection specification)







SCON - [] - [] - [] - [] - RC - 0 - []
 Type Motor type Encoder Type Options I/O type I/O Cable Length Power supply voltage

Contact IAI for model selection items

(1) Master unit

Model		RCON-GW/GWG						
I/O type		Field network						
								
I/O type model number		CC	CIE	DV	EC	EP	PR	PRT
Without fan		○	○	○	○	○	○	○
With 24V driver fan	FU1	○	○	○	○	○	○	○
	FU2	○	○	○	○	○	○	○
	FU3	○	○	○	○	○	○	○
	FU4	○	○	○	○	○	○	○
	FU5	○	○	○	○	○	○	○
	FU6	○	○	○	○	○	○	○
	FU7	○	○	○	○	○	○	○
	FU8	○	○	○	○	○	○	○

Model		RSEL-G									
I/O type		Not used	PIO connection		Field network						
			NPN specification	PNP specification							
I/O type model number		E	NP	PN	CC/CC2	CIE	DV/DV2	EC	EP	PR	PRT
Without fan		○	○	○	○	○	○	○	○	○	○
With 24V driver fan	FU1	○	○	○	○	○	○	○	○	○	○
	FU2	○	○	○	○	○	○	○	○	○	○
	FU3	○	○	○	○	○	○	○	○	○	○
	FU4	○	○	○	○	○	○	○	○	○	○
	FU5	○	○	○	○	○	○	○	○	○	○

Model		REC-GW						
I/O type		Field network						
								
I/O type model number		CC	CIE	DV	EC	EP	PR	PRT

(2) Driver unit

Series code		RCON				
Motor type		24V			230V	
		Pulse motor		AC servo motor	DC brush-less motor	AC servo motor
Type code		Standard type	High thrust type			
Number of Axes	1	○	○	○	○	○
	2	○	—	○	○	—

(3) Extension unit

Series code		RCON				
Type name		SCON extension	PIO/SIO/SCON extension		PIO	
			NPN specification	PNP specification	NPN specification	PNP specification
Type code		EXT	EXT-NP	EXT-PN	NP	PN

(4) EC connection unit

Series code	RCON
Type name	EC connection unit
Type code	EC-4

(5) Simple absolute unit

Series model	RCON	
Motor type	Pulse motor	AC servo motor
Type code	ABU-PC	ABU-AC

(6) 230V power supply unit

Series code	RCON
Type name	230V power supply unit
Type code	PS2-3

(7) SCON controller (RCON-EXT connection specification)

Model	SCON-CB/CGB	
I/O type	RCON connection specification	
I/O type model number	RC	
Supported encoders	Battery-less absolute	Absolute Absolute multi-rotation
	Incremental Absolute Index absolute	
12~150W	○	○
200W	○	○
(100S/200S/300S)	○	○
300~400W	○	○
600W	○	○
750W	○	○
3000~3300W	○	—

System Configuration

RCON

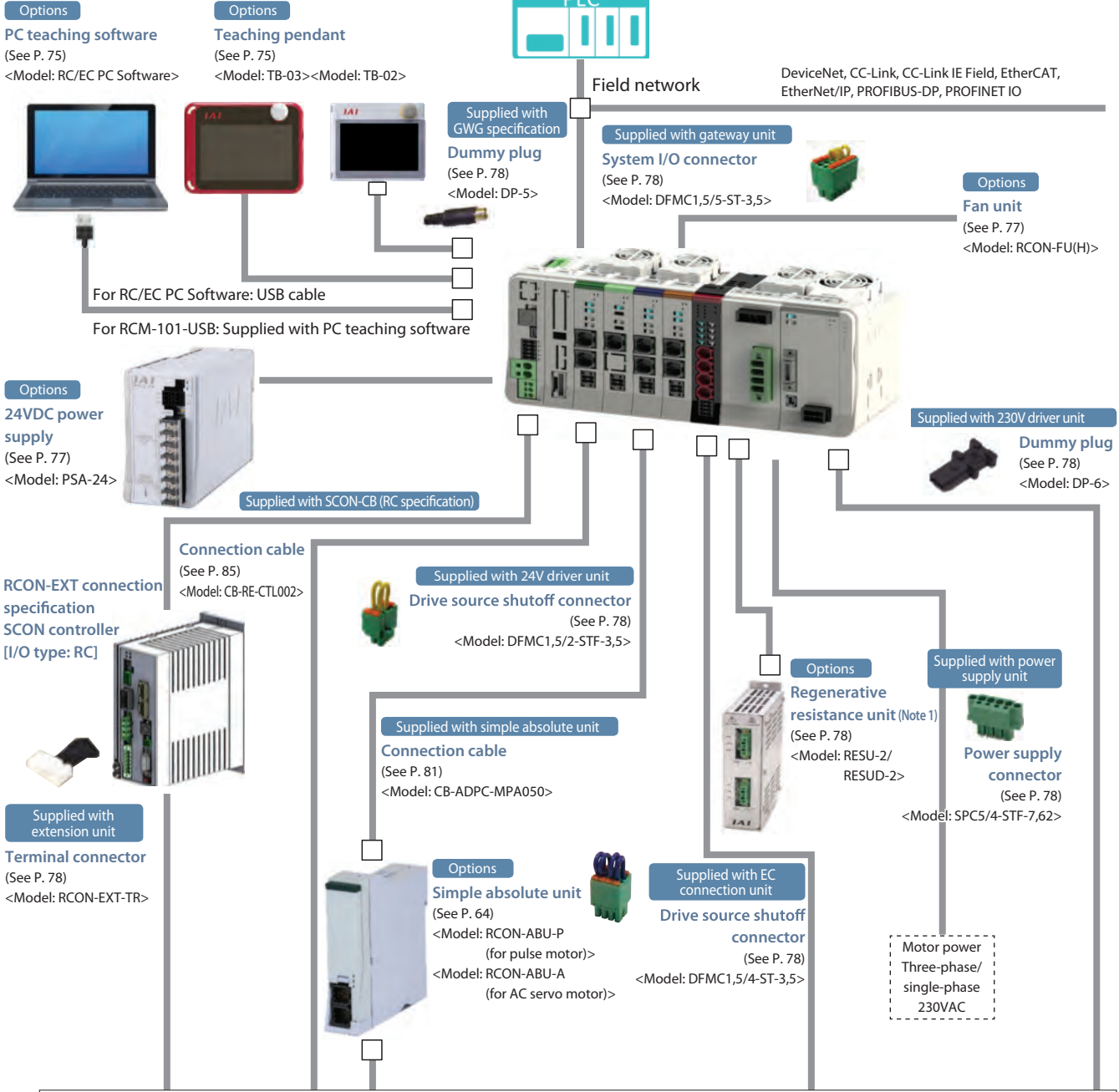

Motor-encoder cables / power/communication cables (EC connection) *1

Connectable actuators	Connection with "extension unit" RCS2/3/4 Series IS(D)B Series SSPA Series DD(A) Series *See P. 46 for actuators that cannot be connected.	Connection with "24V driver unit"		Connection with "EC connection unit" EC Series *2	Connection with "230V driver unit" (60W~750W equipped actuator) RCS2/3/4 Series IS(D)B Series SSPA Series DD(A) Series *See P. 40 for actuators that cannot be connected.
		RCP2/3/4/5/6 Series	RCA/2 Series		
			RCD Series		

*1 The motor/encoder cable is supplied with the actuator. The motor/encoder cables are different according to the actuator type to be connected. Prepare power/communication cables separately for the number of connected axes. See P. 79 for information on ordering single cables.

*2 The EleCylinder can operate only a double solenoid. When connecting a 230V specification, a DC power supply for motor driving is needed. See P. 77 for details.
 Note 1: A 60W regenerative resistor is built-in both RCON-SC and RCON-PS2. There is generally no need for regenerative resistance. However, if there is insufficient regenerative resistance, use the external "regenerative resistance unit".

Unit Configuration

RCON has a locking configuration and uses the unit connection method. Units that can be connected will have the same connector.

However, there are restrictions on unit arrangement. Connect each unit with these restrictions in mind.

Connect each prepared unit in order starting from the left, with the gateway unit serving as the standard unit when looking at the front surface.

*The system will not operate normally if units are not connected in the following order.

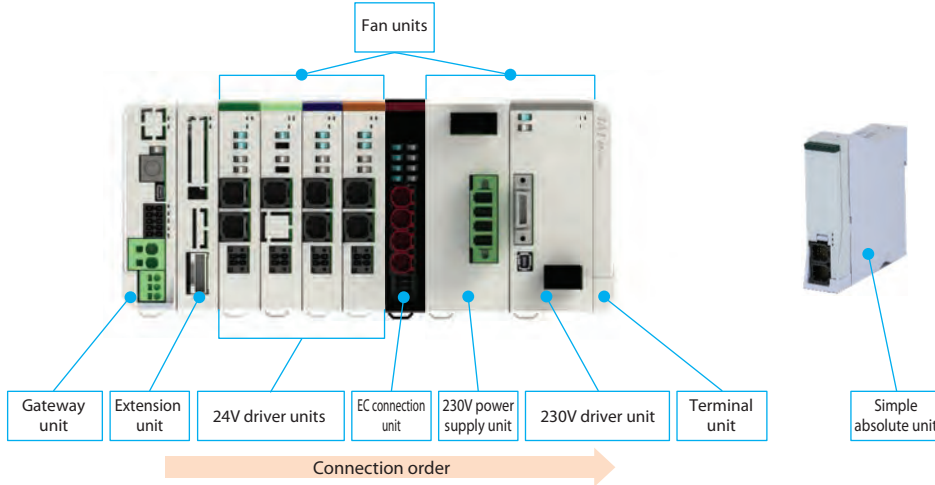

Unit name	Number of connected units	Additional information
Gateway unit	1	Placed at far left
Extension unit	1	Placed to right of gateway unit
24V driver unit	(Max.) 16	Can be rearranged within the unit area
EC connection unit	(Max.) 4	
230V power supply unit	1	Make sure to connect to the left of the leftmost connected 230V driver unit
230V driver unit	(Max.) 16	Can be rearranged within the 230V driver unit area
Terminal unit	1	Place at far right (type differs according to driver connected to left)

(Note) Some limitations apply on the number of connectable axes. See P. 46 for details.

■ Unit name and single product model number list

	Product name	Model	Reference page
Master unit/gateway unit	CC-Link connection specification	RCON-GW/GWG-CC	P54
	CC-Link IE Field connection specification	RCON-GW/GWG-CIE	P55
	DeviceNet connection specification	RCON-GW/GWG-DV	P53
	EtherCAT connection specification	RCON-GW/GWG-EC	P57
	EtherCAT motion connection specification	RCON-GW/GWG-ECM	P57
	EtherNet/IP connection specification	RCON-GW/GWG-EP	P58
	PROFIBUS-DP connection specification	RCON-GW/GWG-PR	P56
	PROFINET IO connection specification	RCON-GW/GWG-PRT	P59
Extension unit	SCON extension	RCON-EXT	P63
24V driver unit	Pulse motor 1-axis specification	RCON-PC-1	P61
	Pulse motor 2-axis specification	RCON-PC-2	
	High thrust pulse motor 1-axis specification	RCON-PCF-1	
	AC servo motor 1-axis specification	RCON-AC-1	
	AC servo motor 2-axis specification	RCON-AC-2	
	DC brush-less motor 1-axis specification	RCON-DC-1	
	DC brush-less motor 2-axis specification	RCON-DC-2	
EC connection unit	EC connection unit 4-axis specification	RCON-EC-4	P64
230V power supply unit	230VAC input power supply	RCON-PS2-3	P62
230V driver unit	AC230V motor 1-axis specification	RCON-SC-1	P62
Terminal unit	For 24V	RCON-GW-TR	P65
	For 230V	RCON-GW-TRS	
Simple absolute unit	For RCON-PC	RCON-ABU-P	P64
	For RCON-AC	RCON-ABU-A	
Fan unit	Other than the below	RCON-FU	P77
	For 230V driver	RCON-FUH	

RSEL

Options

PC teaching software
(See P. 76)
<Model: XSEL PC Software, IA-101-X>

Options

Teaching pendant
(See P. 75)
<Model: TB-03><Model: TB-02>

SEL unit (NP/PN specification) option
PIO cable (See P. 85)
<Model: CB-PAC-PIO***>



For XSEL PC Software : USB cable, Ethernet cable
For IA-101-X(A): Supplied with PC teaching software



Field network

DeviceNet, CC-Link, CC-Link IE Field, EtherCAT, EtherNet/IP, PROFIBUS-DP, PROFINET IO

Supplied with SEL unit
System I/O connector
(See P. 78)
<Model: DFMC1,5/8-ST-3,5>



Options

Fan unit
(See P. 77)
<Model: RCON-FU(H)>

Options

24VDC power supply
(See P. 77)
<Model: PSA-24>



Supplied with unit
SCON connection, PIO/SIO connection



Extension SIO port connector
(See P. 78)
<Model: FMC1,5/3-STF-3,5>



Supplied with 230V driver unit



Dummy plug
(See P. 78)
<Model: DP-6>

RCON-EXT connection specification
SCON controller
[I/O type: RC]



Supplied with SCON (RC specification)

Connection cable
(See P. 85)
<Model: CB-RE-CTL002>

Supplied with SCON connection extension unit

Terminal connector
(See P. 78)
<Model: RCON-EXT-TR>



Supplied with 24V driver unit
Drive source shutoff connector
(See P. 78)
<Model: DFMC1,5/2-STF-3,5>



Supplied with simple absolute unit
Connection cable
(See P. 81)
<Model: CB-ADPC-MPA050>



Options

Simple absolute unit
(See P. 64)
<Model: RCON-ABU-P (for pulse motor)>
<Model: RCON-ABU-A (for AC servo motor)>

Supplied with the EC connection unit
Drive power cutoff connector
(See P. 78)
<Model: DEMC1,5/4-ST-3,5>



Options
Regenerative resistance unit
(Note 1)
(See P. 78)
<Model: RESU-2/ RESUD-2>



Supplied with power supply unit



Power supply connector
(See P. 78)
<Model: SPC5/4-STF-7,62>

Motor power
Three-phase/
single-phase
230VAC

Motor-encoder cables / power/communication cables (EC connection) *1

Connectable actuators

Connection with "extension unit"

RCS2/3/4 Series
IS(D)B Series
SSPA Series
DD(A) Series

*See P. 46 for actuators that cannot be connected.

Connection with "24V driver unit"

RCP2/3/4/5/6 Series
WU Series

RCA/2 Series

RCD Series

Connection with "EC connection unit"

EC Series *2

Connection with "230V driver unit"

(60W~750W equipped actuator)
RCS2/3/4 Series
IS(D)B Series
SSPA Series
DD(A) Series

*See P. 40 for actuators that cannot be connected.

*1 The motor/encoder cable is supplied with the actuator.
The motor/encoder cables are different according to the actuator type to be connected.
See P. 79 when ordering a spare cable.

*2 The EleCylinder can operate only a double solenoid.
When connecting a 230V specification, a DC power supply for motor driving is needed. See P. 77 for details.

Note 1: A 60W regenerative resistor is built-in both RCON-SC and RCON-PS2.
There is generally no need for regenerative resistance. However, if there is insufficient regenerative resistance, use the external "regenerative resistance unit".

Unit Configuration

RSEL has a locking configuration and uses the unit connection method. Units that can be connected will have the same connector. However, there are restrictions on unit arrangement. Connect each unit with these restrictions in mind. Connect each prepared unit in order starting from the left, with the SEL unit serving as the standard unit when looking at the front surface.

* The system will not operate normally if units are not connected in the following order.

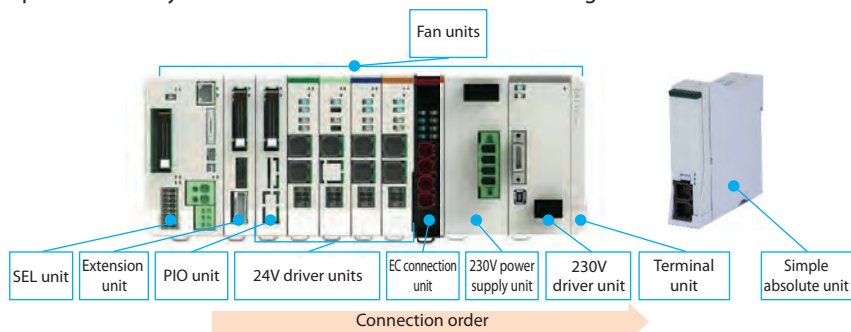

Unit name	Number of connected units	Additional information
SEL unit	1	Placed at far left
Extension unit (SCON connection specification)	1	Select either type
Extension unit (PIO unit)	(Max.) 8	If connecting a PIO/SIO/SCON extension unit, the maximum will be 7
24V driver unit	(Max.) 8	Can be rearranged within the 24V driver unit
EC connection unit	(Max.) 4	
230V power supply unit	1	Make sure to connect to the left of the leftmost connected 230V driver unit
230V driver unit	(Max.) 8	Can be rearranged within the 230V driver unit
Terminal unit	1	Place at far right (type differs according to driver connected to left)

(Note) Some limitations apply on the number of connectable axes. Refer to P. 46 for details.

Unit name and single product model number list

	Product name	Model	Reference page	
Master unit/ SEL unit	No IO connection specification	RSEL-G-E	P60	
	PIO (NPN) connection specification	RSEL-G-NP		
	PIO (PNP) connection specification	RSEL-G-PN		
	CC-Link connection specification	CC-Link connection specification	RSEL-G-CC	P54
		CC-Link connection specification (bifurcated connector supplied)	RSEL-G-CC2	
	CC-Link IE Field connection specification	RSEL-G-CIE	P55	
	DeviceNet connection specification	DeviceNet connection specification	RSEL-G-DV	P53
		DeviceNet connection specification (bifurcated connector supplied)	RSEL-G-DV2	
	EtherCAT connection specification	RSEL-G-EC	P57	
	EtherNet/IP connection specification	RSEL-G-EP	P58	
	PROFIBUS-DP connection specification	RSEL-G-PR	P56	
PROFINET IO connection specification	RSEL-G-PRT	P59		
Extension unit	SCON extension	RCON-EXT	P63	
	PIO/SIO/SCON extension (NPN specification)	RCON-EXT-NP		
	PIO/SIO/SCON extension (PNP specification)	RCON-EXT-PN		
	PIO (NPN specification)	RCON-NP		
	PIO (PNP specification)	RCON-PN		
24V driver unit	Pulse motor 1-axis specification	RCON-PC-1	P61	
	Pulse motor 2-axis specification	RCON-PC-2		
	High thrust pulse motor 1-axis specification	RCON-PCF-1		
	AC servo motor 1-axis specification	RCON-AC-1		
	AC servo motor 2-axis specification	RCON-AC-2		
	DC brush-less motor 1-axis specification	RCON-DC-1		
DC brush-less motor 2-axis specification	RCON-DC-2			
EC connection unit	EC connection unit 4-axis specification	RCON-EC-4	P64	
230V power supply unit	230VAC input power supply	RCON-PS2-3	P62	
230V driver unit	AC230V motor 1-axis specification	RCON-SC-1	P62	
Terminal unit	For 24V	RCON-GW-TR	P65	
	For 230V	RCON-GW-TRS		
Simple absolute unit	For RCON-PC	RCON-ABU-P	P64	
	For RCON-AC	RCON-ABU-A		
Fan unit	Other than the below	RCON-FU	P77	
	For 230V driver	RCON-FUH		

System Configuration

REC

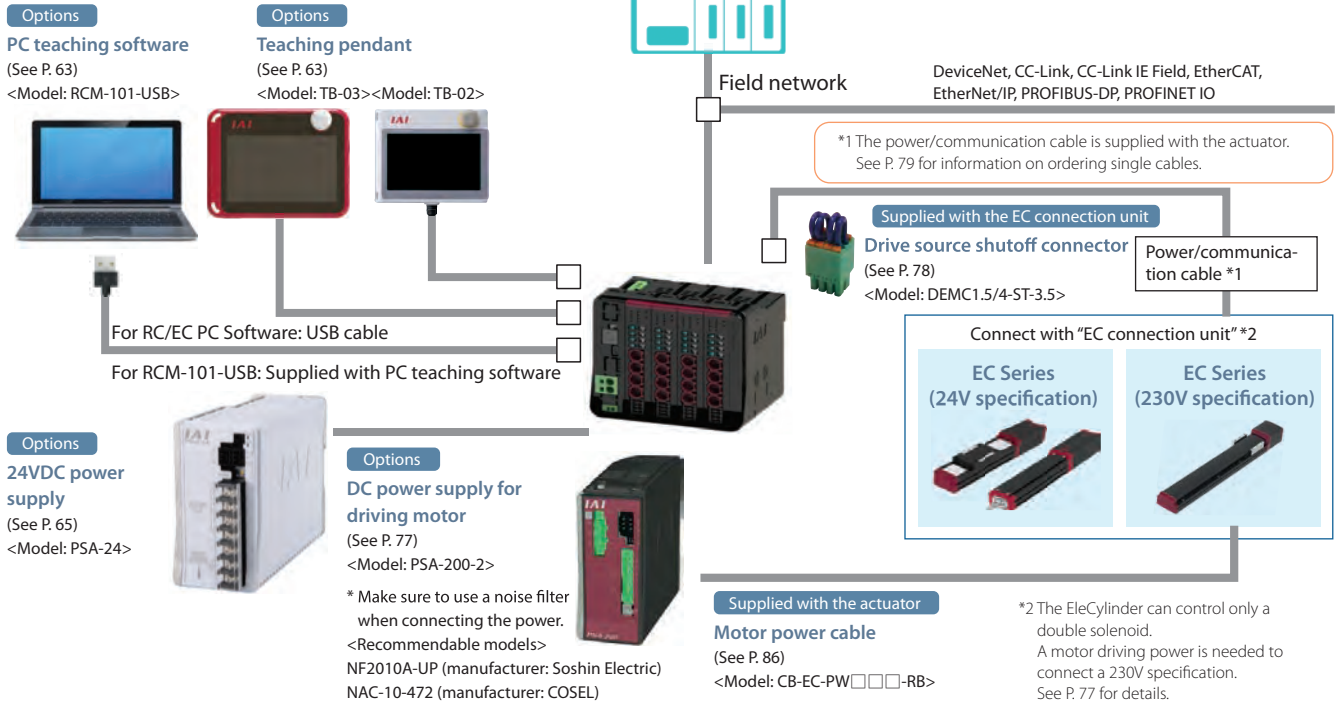

Unit Configuration

The REC has a unit-connecting configuration. Every unit has the same connector and locking configuration. However, there are restrictions on unit arrangement. Connect each unit with these restrictions in mind. Connect each prepared unit in order starting from the left, with the EC gateway unit serving as the standard unit when looking at the front surface.

* The system will not operate normally if units are not connected in the following order.

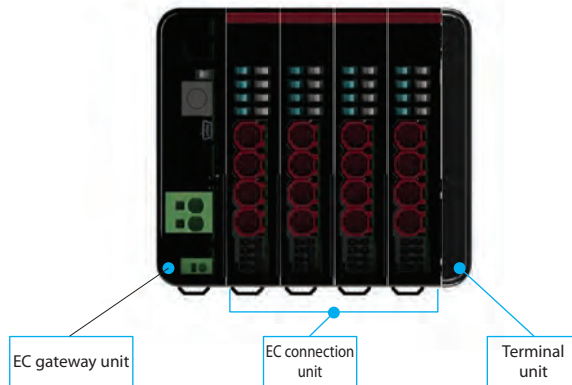

Unit name	Number of connected units	Additional information
EC gateway unit	1	Placed at far left
EC connection unit	(Max.) 4	Can be rearranged within the unit area (max. number of connectable axes is 16 axes)
Terminal unit	1	Placed at far right

(Note) Some limitations apply on the number of connectable axes. Refer to P. 46 for details.

	Product name	Model	Reference page
Master unit/ EC gateway unit	CC-Link connection specification	REC-GW-CC	P54
	CC-Link IE Field connection specification	REC-GW-CIE	P55
	DeviceNet connection specification	REC-GW-DV	P53
	EtherCAT connection specification	REC-GW-EC	P57
	EtherNet/IP connection specification	REC-GW-EP	P58
	PROFIBUS-DP connection specification	REC-GW-PR	P56
	PROFINET IO connection specification	REC-GW-PRT	P59
EC connection unit	EC connection unit 4-axis specification	RCON-EC-4	P64
Terminal unit	For REC	RCON-GW-TRE	P65

■ Actuators not connectable to the R-unit

Master unit	Unit	Driver unit		Expansion unit	EC connection unit (RCON-EC)
		24V driver unit (RCON-PC/PCF/AC/DC)	230V driver unit (RCON-SC)	SCON extension unit/PIO/SIO/SCON extension unit (RCON-EXT)	
	Actuator	24V pulse motor/ 24V AC servo motor/ actuator equipped with DC brush-less motor	Actuator equipped with 230V AC servo motor		EleCylinder
RCON (Note 1)		Wrist unit: WU Table top: TT(A) SCARA robot: IXP Pulse press: RCP6 <Actuators to meet the following specifications> Actuators equipped with an absolute encoder	Servo press: RCS2/RCS3 SCARA robot: IX/IXA RoboCylinder: RCS3-CT8C/CTZ5C (single-phase power supply) Rotary: DD/DDA (single phase power supply)	Servo press: RCS2/RCS3 SCARA robot: IX/IXA	EleCylinder without "ACR" option model
RSEL		Table top: TT(A) SCARA robot: IXP Pulse press: RCP6 <Actuators to meet the following specifications> Actuators equipped with an absolute encoder	<Actuators to meet the following specifications> * Actuators equipped with less than 60W and more than 750W motors. (Except RS-30) * Actuators equipped with an absolute encoder and multi-rotation absolute.	* RCON cannot connect to PIO/SIO/SCON extension unit.	
REC		Not connectable	Not connectable	Not connectable	

(Note1) EtherCAT motion network specification (ECM) cannot connect to some actuators.

Actuator (unit)	Motion network
	ECM
Rotary index mode	Not connectable
EleCylinder (RCON-EC)	Not connectable

■ Limitations on connection

Some limitations apply on the number of connectable actuator axes in each type. Select so that the following conditions are met.

[RCON]

* Make sure that the total number of the connected actuators is less than 16 axes. A multi-slider is calculated as two axes.

* Only the EC connection unit cannot be connected.

Make sure to include the 24V/230V driver unit or a SCON-CB RCON specification in the connection.

* The number of maximum connectable axes differs depending on the operation mode.

Refer to the number of maximum connectable axes (on P. 67).

* The following actuators have limit on the number of max. connectable axes by the 230V power supply unit (only three-phase specification is connectable).

When connecting more than the maximum number of connectable actuators specified in the table below, use the SCON-CB RCON specification connected with an extension unit.

When using actuators other than specified below, select an appropriate one by calculating the power supply capacity (P. 51).

Actuator model	Max. number of connections
DD(A)-LT18(C)□/T18□	8 axes
DD(A)-LH18(C)□/H18□	2 axes
RCS3-CTZ5C	8 axes
RCS3-CT8C	3 axes

[RSEL]

* Make sure that the total number of the connected actuators is less than 16 axes. A multi-slider is calculated as two axes.

However, the total number of the connected actuators for the 24V/230V driver unit or an extension unit (SCON connection specification) is up to 8 axes.

* The following actuators have limit on the number of max. connectable axes by the 230V power supply unit (only three-phase specification is connectable).

When connecting more than the maximum number of connectable actuators specified in the table below, use the SCON-CB RCON specification connected with an extension unit.

When using actuators other than specified below, select an appropriate one by calculating the power supply capacity (P. 51).

Actuator model	Max. number of connections
DD(A)-LT18(C)□/T18□	8 axes
DD(A)-LH18(C)□/H18□	2 axes
RCS3-CTZ5C	8 axes
RCS3-CT8C	3 axes

[REC]

* Make sure that the total number of the connected actuators is less than 16 axes.

■ Recognition of connections

The recognition order of the actuators connected to the R-unit is as specified in the right table. When the connection is over the connectable limitation, actuators of low priority cannot be recognized.

Priority order	Unit name
High	24V driver unit
	230V driver unit
	Extension unit (SCON connection specification)
Low	EC connection unit

General specifications

RCON

Item		Specifications						
Power supply voltage		24VDC \pm 10% 200VAC~230VAC \pm 10% (power supply unit)						
Power supply current		Differs with system configuration						
Number of axes controlled		1 to 16 axes *For maximum axes, see "Maximum number of connectable axes" (P. 67)						
Supported encoders		24V series	Incremental (including ABZ parallel) Battery-less absolute *1					
		230V series	Incremental (including ABZ parallel), battery-less absolute, quasi absolute, index absolute (SCON connection specification) absolute, absolute multi-rotation					
Supported field networks		CC-Link, CC-Link IE Field, DeviceNet, EtherCAT, EtherNet/IP, PROFIBUS-DP, PROFINET IO, EtherCAT motion						
Configuration units		Gateway unit, driver unit, extension unit, EC connection unit, power supply unit, fan unit, terminal unit, simple absolute unit						
SIO interface	Teaching port	Communication method		RS485				
		Communication speed		9.6/19.2/38.4/57.6/115.2/230.4kbps				
	USB port	Communication method		USB				
		Communication speed		12Mbps				
Emergency stop/enable operation		Collective system support with gateway unit STOP signal input, equipped with connectors capable of shutting off the drive power supply to individual axes of each driver unit						
Data recording device		FRAM 256kbit (gateway unit, 24V driver unit) SRAM 4Mbit (230V driver unit)						
Ethernet (optional)		10/100BASE-T (RJ-45 connector) XSEL serial communication protocol (format B) *1						
Data input method	Teaching port	Touch panel teaching pendant						
	USB	PC teaching software						
Calendar function	Retention function	Approx. 10 days						
	Charging time	Approx. 100 hours						
Safety category compliance		B (the safety category specification supports up to 4 external circuits)						
Protection functionality		Overcurrent, abnormal humidity, encoder disconnection, overload						
Preventative/predictive maintenance function		Low electrolytic capacitor capacity and low fan rotation speed						
Ambient operating temperature		(Without fan) 0~40°C, (with fan) 0~55°C *0~40°C for simple absolute units						
Ambient operating humidity		5% RH to 85% RH (non-condensing or freezing)						
Operating atmosphere		Avoid corrosive gas and excessive dust						
Vibration resistance		Frequency: 10~57Hz / Amplitude: 0.075mm, Frequency: 57~150Hz / Acceleration: 9.8m/s ² XYZ directions Sweep time: 10 minutes Number of sweeps: 10 times						
Shock resistance		Drop height: 800mm 1 corner, 3 edges, 6 faces						
Electric shock protection mechanism	24V	Class III						
	230V	Class I						
Degree of protection		IP20						
Insulation withstanding voltage		500VDC 10M Ω						
Cooling method		Natural cooling and forced cooling by fan unit (option)						
Connections between each unit		Unit connection method						
Installation/mounting method		DIN rail (35mm) mounting						
Regulations/standards	Unit name	Gateway unit	24V driver unit	230V driver unit	230V power supply unit	Simple absolute unit	SCON extension unit	EC connection unit
	CE Marking	○	○	○	○	○	○	○
	UL	○	○	○	○	○	○	○

*1 In the case of field network (SSN), the RCP5 (encoder resolution 800) is considered incremental for setting.

■ RSEL-G

Item		Specifications							
Power supply voltage		24VDC ±10% 200VAC~230VAC ±10% (power supply unit)							
Power supply current		Differs with system configuration							
Number of axes controlled		1 to 16 axes *Some limitations apply on the number of connectable axes depending on the actuators and types. (Refer to P. 46)							
Supported encoders	24V series	Incremental (including ABZ parallel) Battery-less absolute							
	230V series	Incremental (including ABZ parallel), battery-less absolute, quasi absolute, index absolute (SCON connection specification) absolute, absolute multi-rotation							
Supported field networks		CC-Link, CC-Link IE Field, DeviceNet, EtherCAT, EtherNet/IP, PROFIBUS-DP, PROFINET IO							
Configuration units		SEL unit, driver unit, SCON extension unit, PIO/SIO/SCON extension unit, PIO unit, power supply unit, fan unit, terminal unit, simple absolute unit, EC connection unit							
Serial communication function	Teaching port	Communication method	RS232C						
		Communication speed	Max. 115.2kbps						
	USB port	Communication method	USB						
		Communication speed	12Mbps full speed						
		Ethernet (RJ-45), PSA-24 communication							
Emergency stop/Enable operation		Collective system support with SEL unit STOP signal input							
Data recording device		Flash ROM + non-volatile RAM (FRAM) *No battery required							
Safety category compliance		B (the safety category specification supports up to 4 external circuits)							
Safety circuit configuration		Duplication allowed							
Emergency stop input		B contact input (external power supply, duplication possible, can be selected from internal power supply)							
Enable input		B contact input (external power supply, duplication possible, can be selected from internal power supply)							
Speed setting		From 1mm/s upper limit depends on the actuator specification							
Acceleration/deceleration setting		From 0.01G upper limit depends on the actuator specification							
Number of axis groups		2 (max. 8 axes per group)							
Programming language		Super SEL language							
No. of programs		512 (up to 99 [BCD specification] or 255 [binary specification] can be selected by input signal)							
Number of programmable steps		20000 steps							
Multi-tasking programs		16 programs							
Number of positions		36000 positions (varies based on number of axis groups)							
Data input method	Teaching port	Touch panel teaching pendant, PC teaching software							
	USB	PC teaching software							
	Ethernet								
Standard I/O (when selecting PIO specification)		(I/O slot selection) Input 16 points/output 16 points							
Expansion I/O		Up to 8 PIO units can be connected							
Ethernet		10/100BASE-T (RJ-45 connector)							
		XSEL serial communication protocol (format B)*1							
USB		USB 2.0 (Mini-B), XSEL serial communication protocol (format B)*1							
Clock function	Retention time	Approx. 10 days							
	Charging time	Approx. 100 hours							
SD card		SD/SDHC (used only for update function)							
Protection functionality		Overcurrent, abnormal temperature, encoder disconnection, overload							
Preventative/predictive maintenance function		Low electrolytic capacitor capacity and low fan rotation speed							
Ambient operating temperature		(Without fan) 0~40°C, (with fan) 0~55°C *0~40°C for simple absolute units							
Ambient operating humidity		5% RH to 85% RH (non-condensing or freezing)							
Operating atmosphere		Avoid corrosive gas and excessive dust							
Vibration resistance		Frequency: 10~57Hz/Amplitude: 0.075mm, Frequency: 57~150Hz/Acceleration: 9.8m/s ² XYZ directions Sweep time: 10 minutes Number of sweeps: 10 times							
Shock resistance		Drop height: 800mm 1 corner, 3 edges, 6 faces							
Electric shock protection mechanism	24V	Class III							
	230V	Class I							
Degree of protection		IP20							
Insulation withstanding voltage		500VDC 10MΩ							
Cooling method		Natural cooling and forced cooling by fan unit (option)							
Connections between each unit		Unit connection method							
Installation/mounting method		DIN rail (35mm) mounting							
Regulations/standards	Unit name	SEL unit	24V driver unit	230V driver unit	230V power supply unit	Simple absolute unit	SCON extension unit	PIO/SIO/SCON extension unit	PIO unit
	CE Marking	○	○	○	○	○	○	○	○
	UL	○	○	○	○	○	○	○	○

*1 XSEL serial communication protocol (format B) can communicate only with 1 port.
The order of priority is teaching port (high priority), USB, then Ethernet (low priority), with no response for low priority.

■ REC-GW

Item		Specifications	
Power supply voltage		24VDC ±10%	
Power supply current		Differs with system configuration	
Number of axes controlled		1~16-axis	
Supported encoders	EC connection	EleCylinder connection only Incremental, battery-less absolute	
Supported field networks		CC-Link, CC-Link IE Field, DeviceNet, EtherCAT, EtherNet/IP, PROFIBUS-DP, PROFINET IO	
Configuration units		EC gateway unit, EC connection unit, terminal unit	
Data input method		Teaching port	Touch panel teaching pendant
		USB	PC teaching software
Serial communication function	Teaching port	Communication method	RS485
		Communication speed	9.6/19.2/38.4/57.6/115.2/230.4kbps
	USB port	Communication method	USB
		Communication speed	12Mbps full speed
Emergency stop/Enable operation		Equipped with connectors capable of shutting off the drive power supply to individual axes of the EC connection unit	
Safety category compliance		Not supported	
Ambient operating temperature		0~55°C	
Ambient operating humidity		5% RH to 85% RH (non-condensing or freezing)	
Operating atmosphere		Avoid corrosive gas and excessive dust	
Vibration resistance		Frequency: 10~57Hz / Amplitude: 0.075mm, Frequency: 57~150Hz / Acceleration: 9.8m/s ² XYZ directions Sweep time: 10 minutes Number of sweeps: 10 times	
Shock resistance		Drop height: 800mm 1 corner, 3 edges, 6 faces	
Electric shock protection mechanism		Class III	
Degree of protection		IP20	
Insulation withstanding voltage		500VDC 10MΩ	
Cooling method		Natural cooling	
Connections between each unit		Unit connection method	
Installation/mounting method		DIN rail (35mm) mounting	
Regulations/standards	Unit name	EC gateway unit	EC connection unit
	CE Marking	○	○
	UL	○	○

Encoder resolution

Item	Motor type	Model	Encoder type	Value [pulse/r]		
24V driver unit	Pulse motor	RCP6	Battery-less Absolute	8192		
		RCP5/RCP4/RCP3/RCP2	Battery-less Absolute	800		
			Incremental			
	WU	Battery-less Absolute	8192			
	AC servo motor	RCA		Battery-less Absolute	16384	
				Incremental	800	
		RCA2	<input type="checkbox"/> <input type="checkbox"/> N/NA Other than the above	Incremental	1048 800	
DC brush-less motor	RCD	RA1R/GRSN RA1DA/GRSNA	Incremental	480		
230V driver unit	AC servo motor	RCS4/RCS3	Battery-less Absolute	16384		
			Incremental			
		RCS2	<input type="checkbox"/> <input type="checkbox"/> 5N	Incremental	1600	
			SR <input type="checkbox"/> 7BD	Incremental	3072	
			Models other than the above	Incremental	16384	
		Battery-less Absolute				
		ISB/ISDB		Battery-less Absolute	131072	
				Incremental	16384	
		ISDBCR/SSPA/ISA/ISDA/IF/FS		Battery-less Absolute	131072	
				Incremental	16384	
		NSA		Battery-less Absolute	131072	
		NS	S <input type="checkbox"/>	Models other than the above	Incremental	2400
						16384
—				-		
DD/DDA			Index absolute	131072		
			Index absolute	1048576		
EC connection unit	Pulse motor	EC	Battery-less Absolute	800		
	AC servo motor		Incremental			
			Battery-less Absolute	16384		

Generated heat (per unit)

Unit name	Unit model	Type	Value
24V driver unit	RCON-PC	PowerCon: No	5.0W
		PowerCon: Yes	8.0W
	RCON-PCF	PowerCon: No	19.2W
	RCON-AC	Standard / High accel/decel / Energy saving	4.5W
	RCON-DC	Standard	3.0W
230V driver unit	RCON-SC		54W
Power supply unit	RCON-PS2		42W

Inrush current

Unit name	Unit model	Type	Value
24V driver unit	RCON-PC		8.3A
	RCON-PCF		10A
	RCON-AC		10A
	RCON-DC		10A
230V driver unit	RCON-SC		25A
EC connection unit	RCON-EC	(For 4-axis connection)	40A

Power capacity

For R-units, make sure for each unit that the calculated results for control power and motor power do not exceed the current limit value for selection calculation, based on the connection configuration. When selecting a 230V driver unit, ensure that the total motor wattage (W) does not exceed the total wattage (W) for the maximum number of connectable axes. Only one RCON-PS2-3 can be used per RCON/RSEL system.

*The maximum number of connectable axes varies by series.

Current limit value		Total motor wattage (W)		DC power supply for driving motor		
Item	Current limit value	Item	Total wattage (W) for max. number of connectable axes	Connected power supply	Max. number of connected axes (per power supply unit)	Max. connectable total motor wattage
Control power	9.0A or less	Motor power	Single-phase 230VAC	AC230V	6-axis	1600W
Motor power	37.5A or less		Three-phase 230VAC			

Power supply capacity <Control power>

Item	Unit			Power capacity
Control power capacity (per unit)	Master unit (including terminal unit)	Gateway unit	Without Ethernet	0.8A
			With Ethernet	1.0A
		SEL unit	1.2A	
		EC gateway unit	0.8A	
	24V driver unit (common for all types)	Without brake		0.2A
		With brake (1-axis specification)		0.4A
		With brake (2-axis specification)		0.6A
	230V driver unit (including 230V power supply unit)	Without brake		0.2A
		With brake		0.5A
	Extension unit (common for each unit)			0.1A
	Simple absolute unit (common to all types)			0.2A
	EC connection unit (per unit)			0.1A
	24V specification EleCylinder (per axis)*	Without brake		0.3A
		With brake		0.5A
	230V specification EleCylinder (per axis)*	Without brake		0.32A
		With brake	EC-S10□, EC-S10X□	0.54A
EC-S13□, EC-S13X□ EC-S15□, EC-S15X□			1.2A	

* Calculate all the axes of connected EleCylinder.

(Note) When selecting a unit, do not include the power supply capacity of the master unit for calculation. Since the 24V input power current of the 230V power supply is minimal, it is negligible for calculation. However, include input power current of the master unit when selecting a 24V power supply.

<Motor power> ● 24V driver unit

Item	Actuator/driver unit			Rated current	Max. current		
	Series	Motor type	When energy-saving is set				
Motor power capacity (per 1-axis actuator)	Pulse motor /RCON-PC	RCP2	20P/20SP/28P	Without PowerCon	0.8A	-	-
		RCP3	28P/35P/42P/56P		1.9A	-	-
		RCP4	28P/35P/42P/42SP/56P	Without PowerCon	1.9A	-	-
		RCP5 RCP6		With PowerCon	2.3A	-	3.9A
	Pulse motor /RCON-PCF	RCP2	56SP/60P/86P	Without PowerCon	5.7A	-	-
		RCP4					
		RCP5					
		RCP6					
	AC servo motor /RCON-AC	RCA RCA2	5W	Standard / Hi-accel./decel.	1.0A	-	3.3A
			10W	Standard / High accel./decel.	1.3A	2.5A	4.4A
			20W		1.3A	2.5A	4.4A
			20W (20S)	Energy saving	1.7A	3.4A	5.1A
			30W		1.3A	2.2A	4.0A
	DC brush-less motor /RCON-DC	RCD	3W	Standard	0.7A	-	1.5A

* Applicable models: RCP2-RA3, RCP2-RGD3

● 230V driver unit

Actuator motor wattage type	Motor power capacity [VA]	Max. instantaneous motor power capacity [VA]
30R (for RS)	138	414
60	138	414
60 (RCS3-CTZ5)	197	591
100	234	702
150	328	984
200	421	1263
200S (DD)	503	1509
400	920	2760
400 (RCS3-CT8)	1230	3690
600	1164	2328
600 (DD)	1462	4386
750	1521	3042

Calculate the power capacity of the following actuators using the “motor wattage for calculation.”

Item	Actuator motor wattage	Motor wattage for calculation	
		Single phase	Three-phase
RCS3-CTZ5C	60W	-	120W
RCS3-CT8C	400W	-	800W

● EC connection unit

(24V specification EleCylinder)

Item		Actuator/connection unit			Power supply current		
		Series	Motor type	Type	Energy-saving disabled		Energy-saving enabled
					Rated current	Max.	
Motor power capacity (per 1-axis actuator)	24V pulse motor	EC	35P/42P/56P	Other than the below	2.2A	3.9A	1.9A
			28P	S3□/RR3□	-	-	1.9A
				RP4/GS4/GW4/TC4/TW4/RTC9/GRB10/GRB13	-	-	1.7A
			20P	GRB8	-	-	0.7A

(230V specification EleCylinder)

Item	Actuator type	Motor wattage [W]	Motor power capacity [VA]	Max. instantaneous motor power capacity [VA]
Motor power capacity (per one axis of actuator)	EC-S10□, EC-S10X□	100	238	714
	EC-S13□, EC-S13X□	200	402	1206
	EC-S15□, EC-S15X□	400	772	2316



Caution

- When acceleration/deceleration of all the axes are operated with the duty ratio of 100%, it is necessary to calculate the motor power using the maximum current value. (If the max. current value is not specified, use the rated current for calculation.)

Master unit

- **Features** This unit is used in order to connect to the field network.
It connects a 24VDC power supply and teaching.
(A terminal unit is supplied.)

DeviceNet connection specification

RCON



■ Model: **RCON-GW/GWG-DV**

RSEL



■ Model: **RSEL-G-DV/DV2**

REC



■ Model: **REC-GW-DV**

Specifications

	RCON	RSEL	REC
Operation type	Positioner Type	Program Type	Positioner Type
Power supply input voltage	24VDC ± 10%		
Power supply current	0.8A (with Ethernet: 1.0A)	1.2A	0.8A
Ambient operating temperature & humidity	0~55°C#, 5%RH to 85%RH (non-condensing or freezing)		
Operating atmosphere	Avoid corrosive gas and excessive dust		
Safety category compliance	GWG specification: 4 compatible	4 compatible	-
Degree of protection	IP20		
Mass	167g	270g	135g
Accessories	(GWG specification) Dummy plug DP-5	Dummy plug DP-4S	-
External dimensions	W 30mm × H 115mm × D 95mm	W 56.6mm × H 115mm × D 95mm	W 30mm × H 115mm × D 95mm
PC teaching software	RCM-101-USB	IA-101-X-*	RCM-101-USB
Teaching pendant	TB-02/TB-03		

A fan unit must be attached during use in environments exceeding 40°C (excluding REC)

Connector area		Cable connector model	Remarks
System IO	Cable side	(RCON) DFMC1,5/5-ST-3,5	Standard accessories
		(RSEL) DFMC1,5/8-ST-3,5	Standard accessories
Drive-source cutoff	Cable side	(REC) DFMC1,5/4-ST-3,5	Standard accessories
Network	Cable side	MSTB2,5/5-STF-5,08 AUM	Standard accessories
		TMSTBP2,5/5-STF-5,08 AUM (bifurcated) *For DV2	Standard accessories
	Controller side	MSTB2,5/5-GF-5,08 AU	

Network connection cable

Pin No.	Signal name (color scheme)	Description	Compatible wire diameter
1(6)	V- (black)	Power supply cable - side	DeviceNet dedicated cable
2(7)	CAN L (blue)	Signal data Low side	
3(8)	-	Drain (shield)	
4(9)	CAN H (white)	Signal data High side	
5(10)	V+ (red)	Power supply cable + side	

*() indicates the bifurcated connector specification

Network connector

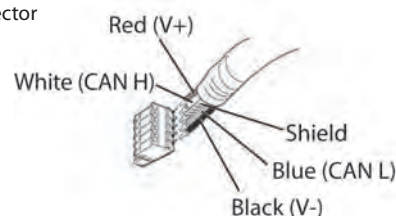
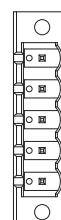

CC-Link connection specification

RCON



■ Model: RCON-GW/GWG-CC

RSEL



■ Model: RSEL-G-CC/CC2

REC



■ Model: REC-GW-CC

Specifications

	RCON	RSEL	REC
Operation type	Positioner Type	Program Type	Positioner Type
Power supply input voltage	24VDC ± 10%		
Power supply current	0.8A (with Ethernet: 1.0A)	1.2A	0.8A
Ambient operating temperature & humidity	0~55°C#, 5%RH to 85%RH (non-condensing or freezing)		
Operating atmosphere	Avoid corrosive gas and excessive dust		
Safety category compliance	GWG specification: 4 compatible	4 compatible	-
Degree of protection	IP20		
Mass	167g	270g	135g
Accessories	(GWG specification) Dummy plug DP-5	Dummy plug DP-4S	-
External dimensions	W 30mm × H 115mm × D 95mm	W 56.6mm × H 115mm × D 95mm	W 30mm × H 115mm × D 95mm
PC teaching software	RCM-101-USB	IA-101-X*	RCM-101-USB
Teaching pendant	TB-02/TB-03		

A fan unit must be attached during use in environments exceeding 40°C (excluding REC)

Connector area		Cable connector model	Remarks
System IO	Cable side	(RCON) DFMC1,5/5-ST-3,5	Standard accessories
		(RSEL) DFMC1,5/8-ST-3,5	Standard accessories
Drive-source cutoff	Cable side	(REC) DFMC1,5/4-ST-3,5	Standard accessories
Network	Cable side	MSTB2,5/5-STF-5,08 AU With 110Ω/130Ω terminal resistor	Standard accessories
		TMSTBP2,5/5-STF-5,08 AU *For CC2 With 110Ω/130Ω terminal resistor	Standard accessories
	Controller side	MSTB2,5/5-GF-5,08 AU	

Network connection cable

Pin No.	Signal name (color scheme)	Description	Compatible wire diameter
1(6)	DA (blue)	Signal line A	CC-Link dedicated cable
2(7)	DB (white)	Signal line B	
3(8)	DG (yellow)	Digital ground	
4(9)	SLD	Connects the shield of shielded cables (5-pin FG and control power connector 1-pin FG connected internally)	
5	FG	Frame ground (4-pin SLD and control power connector 1-pin FG connected internally)	

() indicates the bifurcated connector specification

Network connector

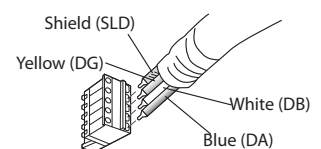

CC-Link IE Field connection specification

RCON



■ Model: **RCON-GW/GWG-CIE**

RSEL



■ Model: **RSEL-G-CIE**

REC



■ Model: **REC-GW-CIE**

Specifications

	RCON	RSEL	REC
Operation type	Positioner Type	Program Type	Positioner Type
Power supply input voltage	24VDC ± 10%		
Power supply current	0.8A (with Ethernet: 1.0A)	1.2A	0.8A
Ambient operating temperature & humidity	0~55°C#, 5%RH to 85%RH (non-condensing or freezing)		
Operating atmosphere	Avoid corrosive gas and excessive dust		
Safety category compliance	GWG specification: 4 compatible	4 compatible	-
Degree of protection	IP20		
Mass	167g	270g	135g
Accessories	(GWG specification) Dummy plug DP-5	Dummy plug DP-4S	-
External dimensions	W 30mm × H 115mm × D 95mm	W 56.6mm × H 115mm × D 95mm	W 30mm × H 115mm × D 95mm
PC teaching software	RCM-101-USB	IA-101-X-*	RCM-101-USB
Teaching pendant	TB-02/TB-03		

A fan unit must be attached during use in environments exceeding 40°C (excluding REC)
CC-link IE Basic is not supported.

Connector area		Cable connector model	Remarks
System IO	Cable side	(RCON) DFMC1,5/5-ST-3,5	Standard accessories
		(RSEL) DFMC1,5/8-ST-3,5	Standard accessories
Drive-source cutoff	Cable side	(REC) DFMC1,5/4-ST-3,5	Standard accessories
Network	Cable side	Ethernet ANSI/TIA/EIA-568-B Category 5e or higher shielded 8P8C modular plug (RJ45)	To be prepared by the customer
	Controller side	Ethernet ANSI/TIA/EIA-568-B Category 5e or higher shielded 8P8C modular plug (RJ45)	

Network connection cable

Pin No.	Signal name	Description	Compatible wire diameter
1	TP0+	Data 0+	For the Ethernet cable, use a straight STP cable of Category 5e or higher.
2	TP0-	Data 0-	
3	TP1+	Data 1+	
4	TP2+	Data 2+	
5	TP2-	Data 2-	
6	TP1-	Data 1-	
7	TP3+	Data 3+	
8	TP3-	Data 3-	

Network connector

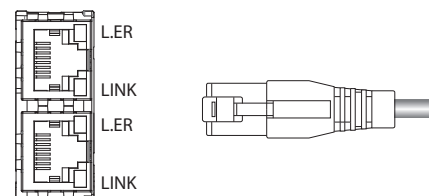

PROFIBUS-DP connection specification

RCON



■ Model: **RCON-GW/GWG-PR**

RSEL



■ Model: **RSEL-G-PR**

REC



■ Model: **REC-GW-PR**

Specifications

	RCON	RSEL	REC
Operation type	Positioner Type	Program Type	Positioner Type
Power supply input voltage	24VDC ± 10%		
Power supply current	0.8A (with Ethernet: 1.0A)	1.2A	0.8A
Ambient operating temperature & humidity	0~55°C#, 5%RH to 85%RH (non-condensing or freezing)		
Operating atmosphere	Avoid corrosive gas and excessive dust		
Safety category compliance	GWG specification: 4 compatible	4 compatible	-
Degree of protection	IP20		
Mass	167g	270g	135g
Accessories	(GWG specification) Dummy plug DP-5	Dummy plug DP-4S	-
External dimensions	W 30mm × H 115mm × D 95mm	W 56.6mm × H 115mm × D 95mm	W 30mm × H 115mm × D 95mm
PC teaching software	RCM-101-USB	IA-101-X*	RCM-101-USB
Teaching pendant	TB-02/TB-03		

A fan unit must be attached during use in environments exceeding 40°C (excluding REC)

Connector area		Cable connector model	Remarks
System IO	Cable side	(RCON) DFMC1,5/5-ST-3,5	Standard accessories
		(RSEL) DFMC1,5/8-ST-3,5	Standard accessories
Drive-source cutoff	Cable side	(REC) DFMC1,5/4-ST-3,5	Standard accessories
Network	Cable side	9-pin D sub connector (male)	To be prepared by the customer
	Controller side	9-pin D sub connector (female)	

Network connection cable

Pin No.	Signal name	Description	Compatible wire diameter
1	NC	Not connected	PROFIBUS-DP dedicated cable (type A: EN5017)
2	NC	Not connected	
3	B-Line	Signal line B (RS-485)	
4	RTS	Transmission request	
5	GND	Signal GND (insulation)	
6	+5V	+5 V output (isolated)	
7	NC	Not connected	
8	A-Line	Signal line A (RS-485)	
9	NC	Not connected	

Network connector

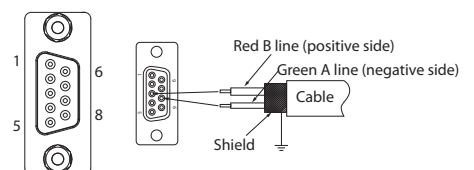

RCON



Model: **RCON-GW/GWG-EC/ECM**

RSEL



Model: **RSEL-G-EC**

REC



Model: **REC-GW-EC**

Specifications

	RCON	RSEL	REC
Operation type	Positioner Type	Program Type	Positioner Type
Power supply input voltage	24VDC ± 10%		
Power supply current	0.8A (with Ethernet: 1.0A)	1.2A	0.8A
Ambient operating temperature & humidity	0~55°C#, 5%RH to 85%RH (non-condensing or freezing)		
Operating atmosphere	Avoid corrosive gas and excessive dust		
Safety category compliance	GWG specification: 4 compatible	4 compatible	-
Degree of protection	IP20		
Mass	167g	270g	135g
Accessories	(GWG specification) Dummy plug DP-5	Dummy plug DP-4S	-
External dimensions	W 30mm × H 115mm × D 95mm	W 56.6mm × H 115mm × D 95mm	W 30mm × H 115mm × D 95mm
PC teaching software	RCM-101-USB	IA-101-X-*	RCM-101-USB
Teaching pendant	TB-02/TB-03		

A fan unit must be attached during use in environments exceeding 40°C (excluding REC)

Connector area		Cable connector model	Remarks
System IO	Cable side	(RCON) DFMC1,5/5-ST-3,5	Standard accessories
		(RSEL) DFMC1,5/8-ST-3,5	Standard accessories
Drive-source cutoff	Cable side	(REC) DFMC1,5/4-ST-3,5	Standard accessories
Network	Cable side	Ethernet ANSI/TIA/EIA-568-B Category 5 or higher shielded 8P8C modular plug (RJ45)	To be prepared by the customer
	Controller side	Ethernet ANSI/TIA/EIA-568-B Category 5 or higher shielded 8P8C modular jack (RJ45)	

Network connection cable

Pin No.	Signal name	Description	Compatible wire diameter
1	TD +	Transmit data +	For the Ethernet cable, use a straight STP cable of Category 5 or higher.
2	TD -	Transmit data -	
3	RD +	Receive data +	
4	-	Not used	
5	-	Not used	
6	RD -	Receive data -	
7	-	Not used	
8	-	Not used	

Network connector

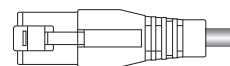
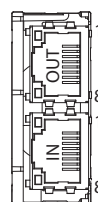

EtherNet/IP connection specification

RCON



■ Model: RCON-GW/GWG-EP

RSEL



■ Model: RSEL-G-EP

REC



■ Model: REC-GW-EP

Specifications

	RCON	RSEL	REC
Operation type	Positioner Type	Program Type	Positioner Type
Power supply input voltage	24VDC ± 10%		
Power supply current	0.8A (with Ethernet: 1.0A)	1.2A	0.8A
Ambient operating temperature & humidity	0~55°C#, 5%RH to 85%RH (non-condensing or freezing)		
Operating atmosphere	Avoid corrosive gas and excessive dust		
Safety category compliance	GWG specification: 4 compatible	4 compatible	-
Degree of protection	IP20		
Mass	167g	270g	135g
Accessories	(GWG specification) Dummy plug DP-5	Dummy plug DP-4S	-
External dimensions	W 30mm × H 115mm × D 95mm	W 56.6mm × H 115mm × D 95mm	W 30mm × H 115mm × D 95mm
PC teaching software	RCM-101-USB	IA-101-X**	RCM-101-USB
Teaching pendant	TB-02/TB-03		

A fan unit must be attached during use in environments exceeding 40°C (excluding REC)
Explicit messaging is not supported. (Implicit messaging only).

Connector area		Cable connector model	Remarks
System IO	Cable side	(RCON) DFMC1,5/5-ST-3,5	Standard accessories
		(RSEL) DFMC1,5/8-ST-3,5	Standard accessories
Drive-source cutoff	Cable side	(REC) DFMC1,5/4-ST-3,5	Standard accessories
Network	Cable side	Ethernet ANSI/TIA/EIA-568-B Category 5 or higher shielded 8P8C modular plug (RJ45)	To be prepared by the customer
	Controller side	Ethernet ANSI/TIA/EIA-568-B Category 5 or higher shielded 8P8C modular jack (RJ45)	

Network connection cable

Pin No.	Signal name	Description	Compatible wire diameter
1	TD +	Transmit data +	For the Ethernet cable, use a straight STP cable of Category 5 or higher.
2	TD -	Transmit data -	
3	RD +	Receive data +	
4	-	Not used	
5	-	Not used	
6	RD -	Receive data -	
7	-	Not used	
8	-	Not used	

Network connector

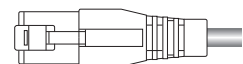

RCON



■ Model: RCON-GW/GWG-PRT

RSEL



■ Model: RSEL-G-PRT

REC



■ Model: REC-GW-PRT

Specifications

	RCON	RSEL	REC
Operation type	Positioner Type	Program Type	Positioner Type
Power supply input voltage	24VDC ± 10%		
Power supply current	0.8A (with Ethernet: 1.0A)	1.2A	0.8A
Ambient operating temperature & humidity	0~55°C#, 5%RH to 85%RH (non-condensing or freezing)		
Operating atmosphere	Avoid corrosive gas and excessive dust		
Safety category compliance	GWG specification: 4 compatible	4 compatible	-
Degree of protection	IP20		
Mass	167g	270g	135g
Accessories	(GWG specification) Dummy plug DP-5	Dummy plug DP-4S	-
External dimensions	W 30mm × H 115mm × D 95mm	W 56.6mm × H 115mm × D 95mm	W 30mm × H 115mm × D 95mm
PC teaching software	RCM-101-USB	IA-101-X**	RCM-101-USB
Teaching pendant	TB-02/TB-03		

A fan unit must be attached during use in environments exceeding 40°C (excluding REC)

Connector area		Cable connector model	Remarks
System IO	Cable side	(RCON) DFMC1,5/5-ST-3,5	Standard accessories
		(RSEL) DFMC1,5/8-ST-3,5	Standard accessories
Drive-source cutoff	Cable side	(REC) DFMC1,5/4-ST-3,5	Standard accessories
Network	Cable side	Ethernet ANSI/TIA/EIA-568-B Category 5 or higher shielded 8P8C modular plug (RJ45)	To be prepared by the customer
	Controller side	Ethernet ANSI/TIA/EIA-568-B Category 5 or higher shielded 8P8C modular jack (RJ45)	

Network connection cable

Pin No.	Signal name	Description	Compatible wire diameter
1	TD +	Transmit data +	For the Ethernet cable, use a straight STP cable of Category 5 or higher.
2	TD -	Transmit data -	
3	RD +	Receive data +	
4	-	Not used	
5	-	Not used	
6	RD -	Receive data -	
7	-	Not used	
8	-	Not used	

Network connector

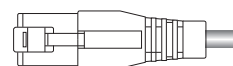

No I/O connection specification

RSEL



Model: **RSEL-G-E**

Specifications

	RSEL
Operation type	Program Type
Power supply input voltage	24VDC ± 10%
Power supply current	1.2A
Ambient operating temperature & humidity	0~55°C#, 5%RH to 85%RH (non-condensing or freezing)
Operating atmosphere	Avoid corrosive gas and excessive dust
Safety category compliance	4 compatible
Degree of protection	IP20
Mass	270g
Accessory	Dummy plug DP-4S
External dimensions	W 56.6mm × H 115mm × D 95mm
PC teaching software	IA-101-X-*
Teaching pendant	TB-02/TB-03

A fan unit must be attached during use in environments exceeding 40°C (excluding REC)

Connector	Cable connector model (manufacturer)	Remarks
System IO	Cable side DFMC1,5/8-ST-3,5 (Phoenix Contact)	

NPN/PNP connection specification

RSEL



Model: **RSEL-G-NP/PN**

Specifications

	RSEL
Operation type	Program Type
Power supply input voltage	24VDC ± 10%
Power supply current	1.2A
Ambient operating temperature & humidity	0~55°C#, 5%RH to 85%RH (non-condensing or freezing)
Operating atmosphere	Avoid corrosive gas and excessive dust
Safety category compliance	4 compatible
Degree of protection	IP20
Mass	270g
Accessory	Dummy plug DP-4S, PIO flat cable CB-PAC-PIO*** ##
External dimensions	W 56.6mm × H 115mm × D 95mm
PC teaching software	IA-101-X-*
Teaching pendant	TB-02/TB-03

A fan unit must be attached during use in environments exceeding 40°C (excluding REC)

If the cable length of the model specification is 0m, PIO cable is not supplied.

Connector	Cable connector model (manufacturer)	Remarks
System IO	Cable side DFMC1,5/8-ST-3,5 (Phoenix Contact)	
IO slot	Cable side HIF6-40PA-1,27R*	Options
	Controller side HIF6-40PA-1,27DS(71)	

*Connect an IO cable (CB-PAC-PIO□□□□)
Refer to P. 66 for PIO signal table and internal circuit

Driver Unit

■ Features A controller unit for actuator control.

24V driver unit for RCP series connection

A driver unit for stepper motor connection.
Can be connected to all RCP series actuators.



Model	Type	Compatible motor capacity
RCON-PC-1	1-axis connection	1.2A (□20/28/35/42/56)
RCON-PC-2	2-axis connection	
RCON-PCF-1	1-axis connection *For high thrust	4A (□56/60/86)

Specifications

Power	24VDC ± 10%
Control power	(Without brake) 0.2A (With brake, 1-axis specification) 0.4A (With brake, 2-axis specification) 0.6A
Ambient operating temperature & humidity	(Without fan) 0~40°C (With fan) 0~55°C, 5% RH to 85% RH (non-condensing or freezing)
Operating atmosphere	Avoid corrosive gas and excessive dust
Degree of protection	IP20
Mass	(1-axis specification) 175g (2-axis specification) 180g
External dimensions	W22.6mm × H115mm × D95mm
Accessories	Drive source shutoff connector (DFMC1,5/2-STF-3,5)
Compatible Type	RCON/RSEL

24V driver unit for RCA series connection

A driver unit for AC servo motor connection.
Can be connected to all RCA series actuators.



Model	Type	Compatible motor capacity
RCON-AC-1	1-axis connection	2W - 30W
RCON-AC-2	2-axis connection	

Specifications

Power	24VDC ± 10%
Control power	(Without brake) 0.2A (With brake, 1-axis specification) 0.4A (With brake, 2-axis specification) 0.6A
Ambient operating temperature & humidity	(Without fan) 0~40°C (With fan) 0~55°C, 5% RH to 85% RH (non-condensing or freezing)
Operating atmosphere	Avoid corrosive gas and excessive dust
Degree of protection	IP20
Mass	(1-axis specification) 175g (2-axis specification) 180g
External dimensions	W22.6mm × H115mm × D95mm
Accessories	Drive source shutoff connector (DFMC1,5/2-STF-3,5)
Compatible Type	RCON/RSEL

24V driver unit for RCD series connection

A driver unit for DC brush-less motor connection.
Can be connected to all RCD series actuators.



Model	Type	Compatible motor capacity
RCON-DC-1	1-axis connection	3W
RCON-DC-2	2-axis connection	

Specifications

Power	24VDC ± 10%
Control power	(Without brake) 0.2A (With brake, 1-axis specification) 0.4A (With brake, 2-axis specification) 0.6A
Ambient operating temperature & humidity	(Without fan) 0~40°C (With fan) 0~55°C, 5% RH to 85% RH (non-condensing or freezing)
Operating atmosphere	Avoid corrosive gas and excessive dust
Degree of protection	IP20
Mass	(1-axis specification) 175g (2-axis specification) 180g
External dimensions	W22.6mm × H115mm × D95mm
Accessories	Drive source shutoff connector (DFMC1,5/2-STF-3,5)
Compatible Type	RCON/RSEL

230V driver unit 230V AC motor-equipped actuator connection

This driver unit connects 230VAC servo actuators from 60W to 750W.



Model	Type	Compatible motor capacity
RCON-SC	1-axis connection	60W/100W/150W/200W 300W/400W/600W/750W

Specifications

Control power input specification	24VDC \pm 10%
Control power	(Without brake) 0.2A (With brake) 0.5A
Ambient operating temperature & humidity	(With fan) 0~55°C, 5% RH to 85% RH (non-condensing or freezing)
Operating atmosphere	Avoid corrosive gas and excessive dust
Degree of protection	IP20
Mass	438g
External dimensions	W45.2mm×H115mm×D95mm
Accessories	Fan unit RCON-FUH, dummy plug DP-6
Compatible Type	RCON/RSEL

Example: With 3-phase 230VAC power supply (max 2400W), 6 axes of 400W types can be connected with 6 units of RCON-SC-1 and 1 unit of RCON-PS2-3.

230V power supply unit

This power supply unit is for 230VAC input only. A 230V driver unit must be connected.



Model
RCON-PS2-3

*A terminal unit is supplied (RCON-GW-TRS).

Specifications

Motor power input voltage	Single-phase/three-phase 200VAC~230VAC \pm 10%
Maximum power capacity	1600W (1-phase 230VAC) 2400W (3-phase 230VAC)
Ambient operating temperature & humidity	(With fan) 0~55°C, 5% RH to 85% RH (non-condensing or freezing)
Operating atmosphere	Avoid corrosive gas and excessive dust
Degree of protection	IP20
Mass	393g
External dimensions	W45.2mm×H115mm×D95mm
Accessories	Fan unit RCON-FU, power supply connector SPC5/4-STF-7,62
Compatible Type	RCON/RSEL

* A noise filter is installed inside.

Other Units

SCON extension unit

SCON-CB/CGB can be connected to operate an actuator with 230V motor.

RCON
RSEL



Model
RCON-EXT

Specifications

Power	24VDC ± 10%
Control power	0.1A
Ambient operating temperature & humidity	0~55°C, 5% RH to 85% RH (non-condensing or freezing)
Operating atmosphere	Avoid corrosive gas and excessive dust
Degree of protection	IP20
Mass	99g
External dimensions	W22.6mm × H115mm × D95mm
Accessories	Terminal connector RCON-EXT-TR
Compatible Type	RCON/RSEL

PIO/SIO/SCON extension unit

This specification model allows PIO/SIO to be connected to an extension unit for connecting SCON-CB/CGB.

RSEL



Model
RCON-EXT-NP (NPN specification)
RCON-EXT-PN (PNP specification)

Specifications

Power	24VDC ± 10%
Control power	0.1A
Input Output	Input 16 points, Output 16 points
Ambient operating temperature & humidity	0~55°C, 5% RH to 85% RH (non-condensing or freezing)
Operating atmosphere	Avoid corrosive gas and excessive dust
Degree of protection	IP20
Mass	110g
External dimensions	W22.6mm × H115mm × D95mm
Accessories	Expansion SIO port connector FMC1,5/3-STF-3,5 Terminal connector RCON-EXT-TR PIO cable CB-PAC-PIO*** (In case the cable length model other than "0" is specified)
Compatible Type	RSEL

* Refer to P. 66 for PIO signal table and internal circuit

PIO unit

This unit is for PIO extension.

RSEL



Model
RCON-NP (NPN specification)
RCON-PN (PNP specification)

Specifications

Power	24VDC ± 10%
Control power	0.1A
Input Output	Input 16 points, Output 16 points
Ambient operating temperature & humidity	0~55°C, 5% RH to 85% RH (non-condensing or freezing)
Operating atmosphere	Avoid corrosive gas and excessive dust
Degree of protection	IP20
Mass	105g
External dimensions	W22.6mm × H115mm × D95mm
Accessories	PIO cable CB-PAC-PIO*** (In case the cable length model other than "0" is specified)
Compatible Type	RSEL

* Refer to P. 66 for PIO signal table and internal circuit

EC connection unit

This unit allows up to 4 axes of EleCylinder with ACR option to be connected.

RCON
RSEL
REC



Model
RCON-EC

Specifications

Power	24VDC ± 10%
Control power	0.1A
Ambient operating temperature & humidity	0~55°C, 5% RH to 85% RH (non-condensing or freezing)
Operating atmosphere	Avoid corrosive gas and excessive dust
Degree of protection	IP20
Mass	123g
External dimensions	W22.6mm×H115mm×D95mm
Accessories	Drive source shutoff connector (DFMC1,5/4-ST-3,5 (REC))
Compatible Type	RCON/RSEL/REC

Simple absolute unit

*For 24V driver connection

This unit is to be connected when using an actuator with incremental specification as absolute specification.

RCON
RSEL



Model	Type	Compatible motor
RCON-ABU-P	For RCP series connection	Pulse motor
RCON-ABU-A	For RCA series connection	AC servo motor

Specifications

Power	24VDC ± 10%
Control power	0.2A
Absolute battery model	AB-7
Battery voltage	3.6V
Charging time	Approx. 72 hours
Ambient operating temperature & humidity	0~40°C, 5% RH to 85% RH (non-condensing or freezing)
Operating atmosphere	Avoid corrosive gas and excessive dust
Degree of protection	IP20
Mass	271g (including 173g for absolute battery)
External dimensions	W22.6mm×H115mm×D95mm
Accessories	Cable (CB-ADPC-MPA005)
Compatible Type	RCON/RSEL

Terminal unit

A terminal resistor for returning RCON/RSEL serial communication and input/output signals. (Supplied with purchase of gateway unit.)

**RCON
RSEL**



Model
RCON-GW-TR

Specifications

Power	24VDC ± 10%
Ambient operating temperature & humidity	0~55°C, 5% RH to 85% RH (non-condensing or freezing)
Operating atmosphere	Avoid corrosive gas and excessive dust
Degree of protection	IP20
Mass	48g
External dimensions	W12.6mm × H115mm × D95mm
Compatible Type	RCON without RCON-PS2-3 RSEL without RCON-PS2-3

230V terminal unit

This terminal resistor is for connecting a 230VAC driver unit. (Supplied with purchase of power supply unit.)

**RCON
RSEL**



Model
RCON-GW-TRS

Specifications

Power	24VDC ± 10%
Ambient operating temperature & humidity	0~55°C, 5% RH to 85% RH (non-condensing or freezing)
Operating atmosphere	Avoid corrosive gas and excessive dust
Degree of protection	IP20
Mass	40g
External dimensions	W12.6mm × H115mm × D95mm
Compatible Type	RCON with RCON-PS2-3 RSEL with RCON-PS2-3

REC terminal unit

This terminal resistor is for connecting an EC module only. (Supplied with purchase of gateway unit.)

REC



Model
RCON-GW-TRE

Specifications

Power	24VDC ± 10%
Ambient operating temperature & humidity	0~55°C, 5% RH to 85% RH (non-condensing or freezing)
Operating atmosphere	Avoid corrosive gas and excessive dust
Degree of protection	IP20
Mass	48g
External dimensions	W12.6mm × H115mm × D95mm
Compatible Type	REC

PIO Signal Chart

Standard PIO connector, extension PIO connector pin layout

Pin No.	Category	Assignment	Pin No.	Category	Assignment
1A	24V	P24	1B	Output	OUT0
2A	24V	P24	2B		OUT1
3A	-	-	3B		OUT2
4A	-	-	4B		OUT3
5A	Input	IN0	5B		OUT4
6A		IN1	6B		OUT5
7A		IN2	7B		OUT6
8A		IN3	8B		OUT7
9A		IN4	9B		OUT8
10A		IN5	10B		OUT9
11A		IN6	11B		OUT10
12A		IN7	12B		OUT11
13A		IN8	13B		OUT12
14A		IN9	14B		OUT13
15A		IN10	15B		OUT14
16A		IN11	16B		OUT15
17A		IN12	17B	-	
18A		IN13	18B	-	
19A		IN14	19B	0V	N
20A	IN15	20B	0V	N	

* The same assignment will be applied to each unit even for an extension unit (PIO specification).

I/O internal circuit

[Input]

Item	Specifications
Number of input	16 points
Input voltage	24VDC \pm 10%
Input current	4mA/1 circuit
On/off voltage	On voltage: Min. 18VDC (3.5mA) Off voltage: Max. 6VDC (1mA)
Isolation method	Photocoupler

[NPN specification]

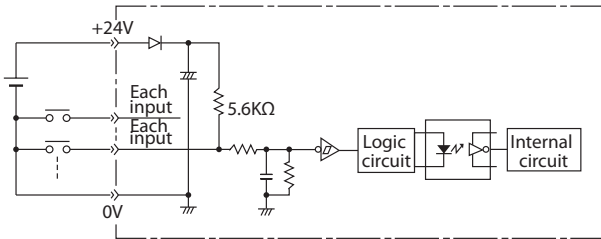

[PNP specification]

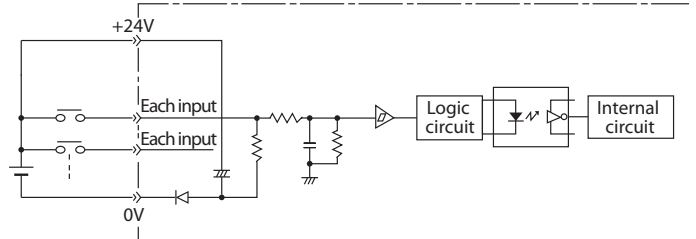

[Output]

Item	Specifications
Output current	16 points
Rated load voltage	24VDC \pm 10%
Max. current	50mA/1 circuit
Isolation method	Photocoupler

[NPN specification]

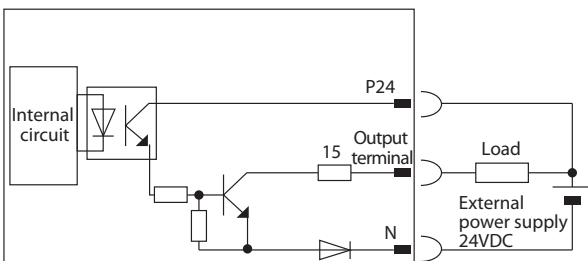

[PNP specification]

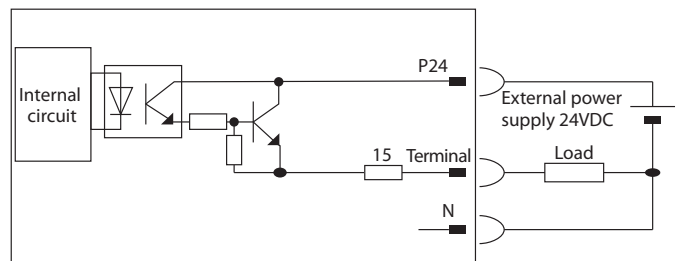

Maximum connectable axes by RCON-GW operation mode

The max. number of connectable axes when all the axes operate in the same operation mode.

* If different operation modes exist, please ask IAI.

Field network	Operation mode	Remote I/O					Motion network	
		Direct numerical control mode	Simple direct mode	Positioner mode 1	Positioner mode 2	Positioner mode 3		Positioner mode 5
DeviceNet		8 axes	16 axes	16 axes	16 axes	16 axes	16 axes	-
CC-Link		16 axes	16 axes	16 axes	16 axes	16 axes	16 axes	-
CC-Link IE Field		16 axes	16 axes	16 axes	16 axes	16 axes	16 axes	-
PROFIBUS-DP		8 axes	16 axes	16 axes	16 axes	16 axes	16 axes	-
EtherCAT		8 axes	16 axes	16 axes	16 axes	16 axes	16 axes	-
EtherNet/IP		8 axes	16 axes	16 axes	16 axes	16 axes	16 axes	-
PROFINET IO		8 axes	16 axes	16 axes	16 axes	16 axes	16 axes	-
EtherCAT motion		-	-	-	-	-	-	8 axes

Field Network Operation Mode (EtherCAT motion is excluded)

The RCON-GW field network control operation mode can be selected from the following control modes.

Data required for operation (target position, speed, acceleration, push current value, etc.) are written by a connected PLC or other host controller into the specified addresses. * The EC connection unit is not supported.

Operation mode	Description	Overview
Direct numerical control mode	This mode allows designating the target position, speed, acceleration/deceleration, and current limit value for pushing numerically. Also, it is capable of monitoring the present position, present speed, and the command current value with 0.01mm increments.	
Simple direct value mode	Can modify any of the stored target positions by numerical value. Also allows monitoring of the present position numerically with 0.01mm increments.	
Positioner 1 mode	Can store up to 128 points of position data, and can move to the stored position. Also allows monitoring of the present position numerically with 0.01mm increments.	
Positioner 2 mode	Can store up to 128 points of position data, and can move to the stored position. This mode does not allow monitoring of the present position. This mode has less in/out data transfer volume than the Positioner 1 mode.	
Positioner 3 mode	Can store up to 128 points of position data, and can move to the stored position. This mode does not allow monitoring of the present position. This mode has less in/out data transfer volume than the Positioner 2 mode, and controls travel with the minimum of signals.	
Positioner 5 mode	Can store up to 16 points of position data, and can move to the stored position. This mode has less in/out data transfer volume and fewer positioning tables than the Positioner 2 mode, and allows monitoring of the present position numerically with 0.1mm increments.	

List of Functions by Operation Mode (EtherCAT motion is excluded)

* The EC connection unit is not supported.

	Direct numerical control mode	Simple direct value mode	Positioner 1 mode	Positioner 2 mode	Positioner 3 mode	Positioner 5 mode
Number of positioning points	Unlimited	128 points	128 points	128 points	128 points	16 points
Home return motion	○	○	○	○	○	○
Positioning operation	○	○	△	△	△	△
Speed, acceleration/ deceleration settings	○	△ (Note 1)	△	△	△	△
Different acceleration and deceleration settings	—	△	△	△	△	△
Pitch feed (incremental)	○	△	△	△	—	△
JOG operation	△	△	△	△	—	△
Position data writing	—	—	○	○	—	—
Push-motion operation	○	△	△	△	△	△
Speed changes while traveling	○	△	△	△	△	△
Pausing	○	○	○	○	○	○
Zone signal output	△ (2 points)	△ (2 points)	△ (2 points)	△ (2 points)	△ (1 point)	△ (2 points)
Position zone signal output	—	△	△	△	—	—
Overload warning output	○	○	○	○	—	○
Vibration control (Note 2)	—	△	△	△	△	△
Collision detection function (Note 3)	—	△	△	△	△	△
Current position reading (Note 4) (resolution)	○ (0.01mm)	○ (0.01mm)	○ (0.01mm)	—	—	○ (Note 5) (0.1mm)

* ○ : Direct setting is possible, △ : Position data or parameter input is required, — : The operation is not supported.

Note 1: Up to 128 points of position data can be set.

Note 2: This function is limited to the AC servo motor specification.

Note 3: This function is limited to the pulse motor specification.

Note 4: The resolution to control a DD motor is 0.001 degree (0.01 degree for positioner 5 mode only).

Note 5: The maximum output value in positioner 5 mode is 3276.7mm (327.67 degrees for DD motor).

To control the actuator in an operation range exceeding the maximum value, select a different operation mode.

EleCylinder I/O signal table

Pin assignment of the power supply and I/O connector

Pin No.	Connector decal	Signal abbreviation	Function description
B3	Backward	STO	Backward command
B4	Forward	ST1	Forward command
B5	Alarm cancel	RES	Alarm cancel
A3	Backward complete	LSO/PEO	Backward complete/Push complete
A4	Forward complete	LS1/PE1	Forward complete/Push complete
A5	Alarm	*ALM	Alarm detection (b-contact)
B2	Brake release	BKRLS	Brake forced release (in case of with brake specification)
B1	24V	24V	24V input
A1	0V	0V	0V input
A2	(24V)	(24V)	24V input

Master unit

RCON

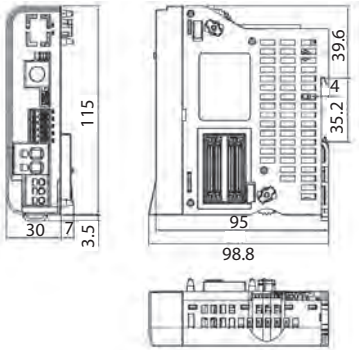

RSEL

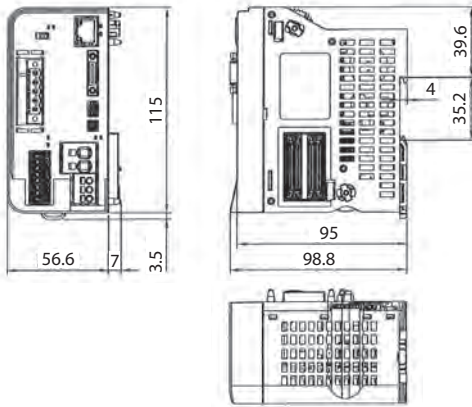

REC

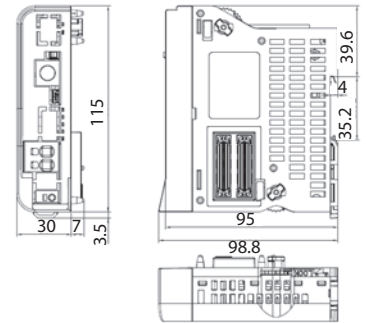

Driver Unit

24V

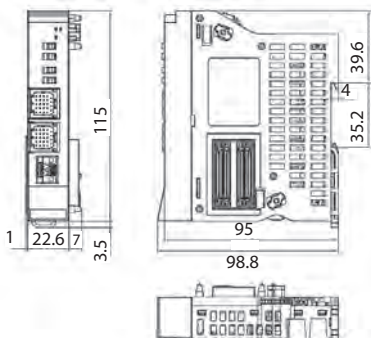

230V

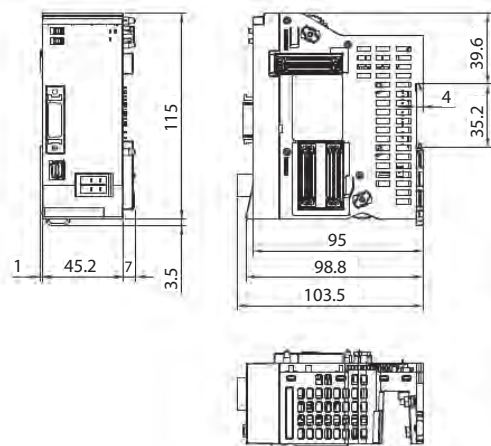

230V power supply unit

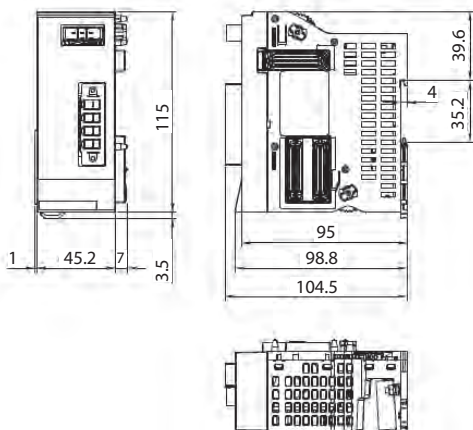

EC connection unit

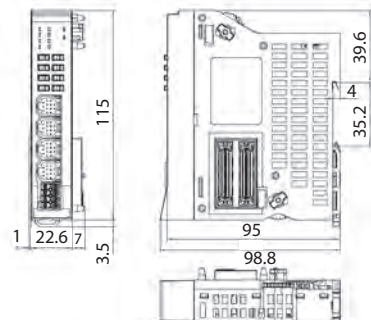

Extension unit

SCON extension

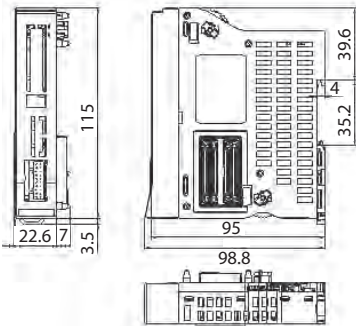

PIO/SIO/SCON extension

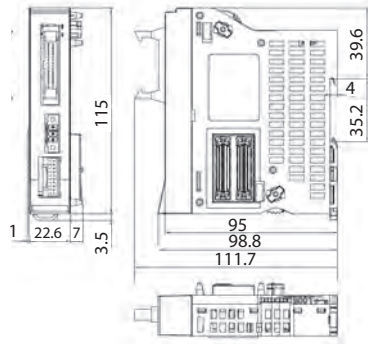

PIO

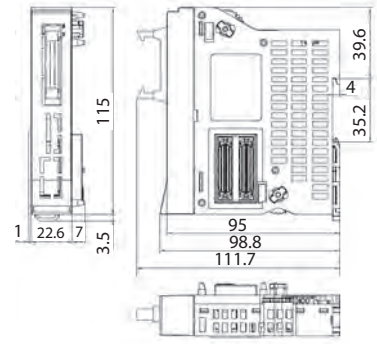

Terminal unit

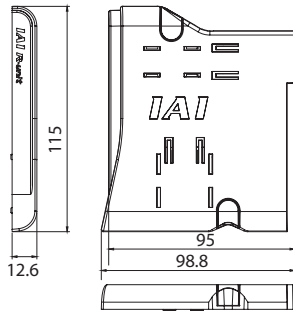

Simple absolute unit

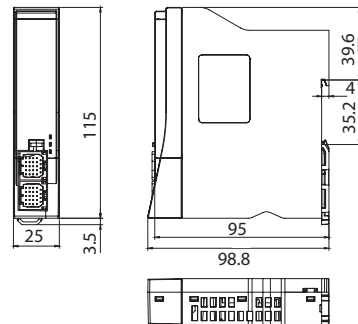

Fan unit

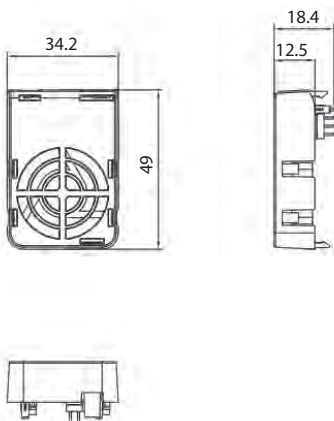

For 230V driver

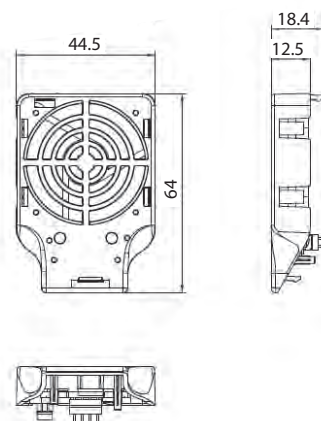

RCON

8 24V driver units (16 axes)

With fan

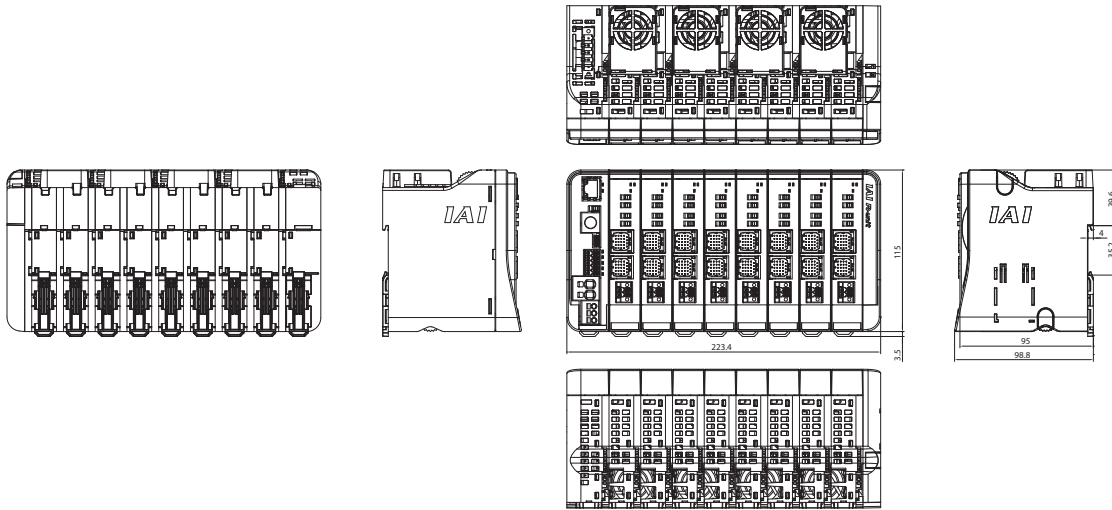

RCON

1 230V driver unit (1 axis)

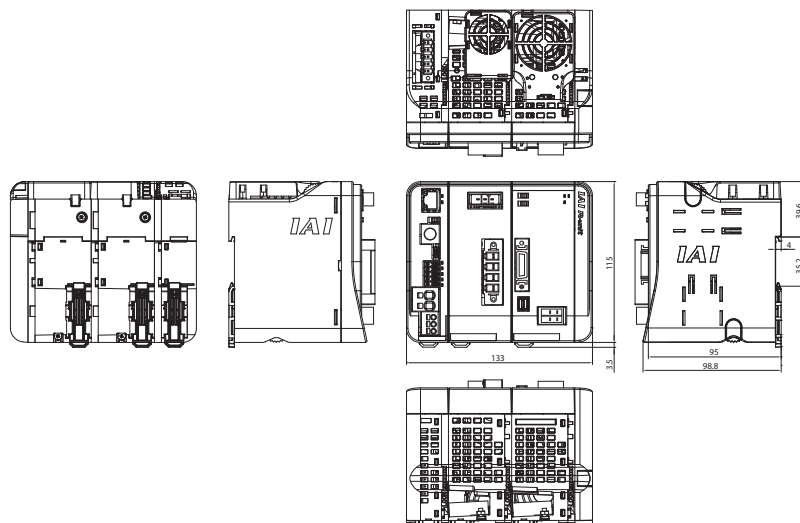

RSEL

Extension unit (SCON connection, PIO unit)

2 230V drivers (2 axes)

With fan

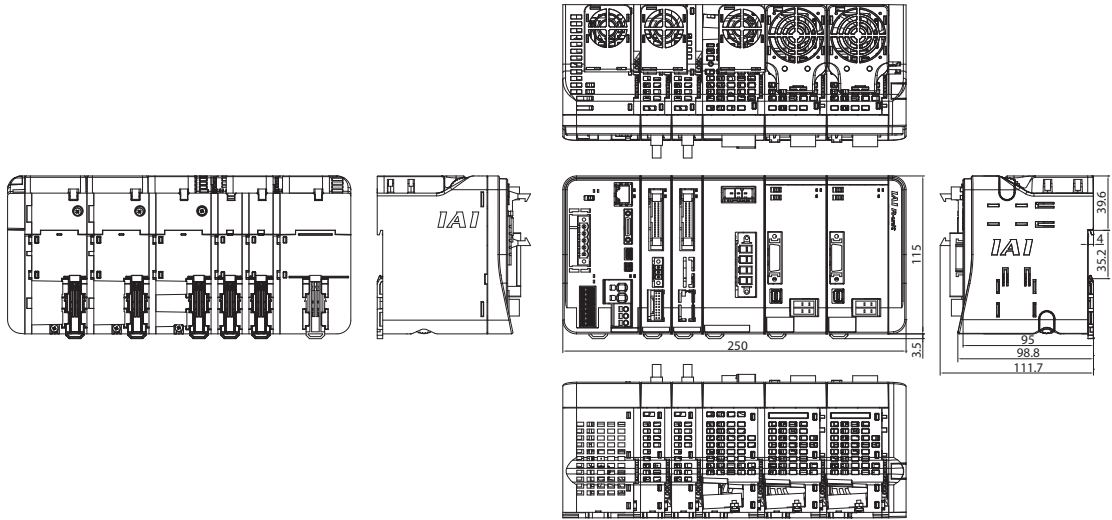

REC

For 4 EC connection units (16 axes)

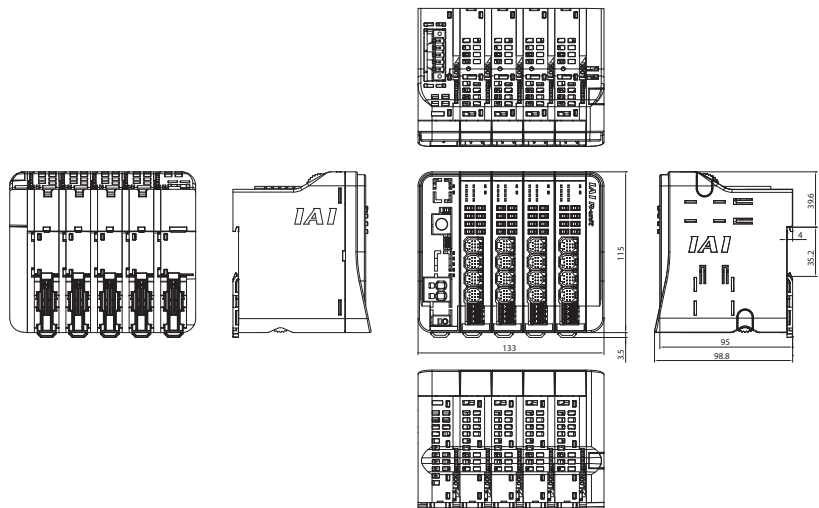

Name of Each Component

Master unit

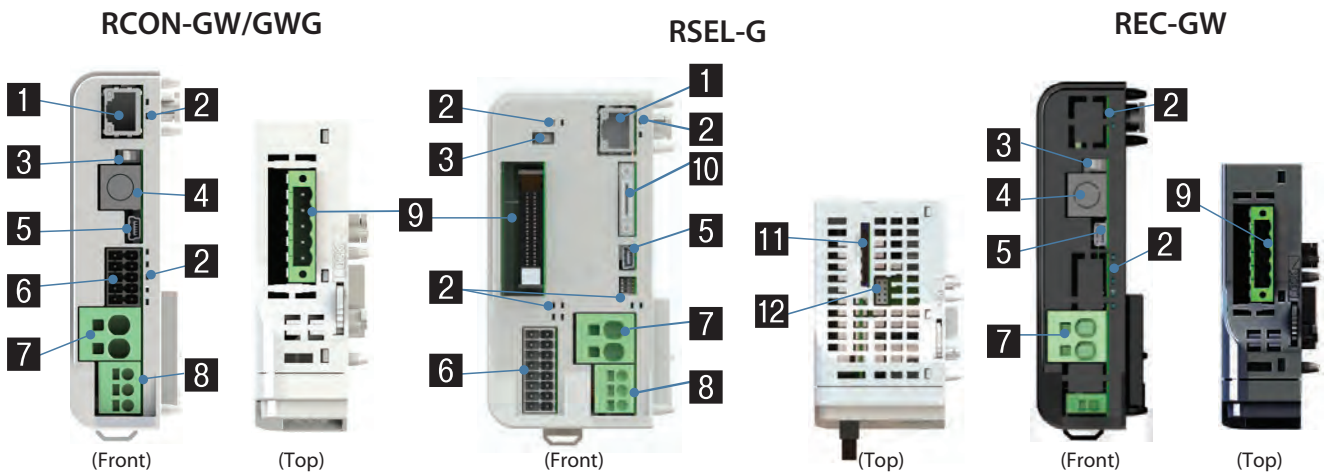

1 EtherNet connector

A connector for connecting to EtherNet.
(Selected as option for RCON.)

2 Status LED

Represents the state of the controller.

3 AUTO/MANU switch

A switch for automatic/manual operation.

4 SIO connector

A connector for connecting the teaching pendant and PC teaching software cable.

5 USB connector

A connector for connecting the PC teaching software cable.

6 System I/O connector

A connector with a serial communication line for STOP input and PSA-24.
Allows for external AUTO/MANU switching input for RCON.

7 Motor power connector

Motor power +24V supply connector.

8 Control power connector

A connector for connecting control power +24V and FG.

9 Fieldbus connector/IO connector

A connector for connecting the fieldbus connector selected in I/O type.

10 Teaching connector

A connector for connecting the teaching pendant and PC dedicated software via RS232.

11 Memory card slot

Insert an SD/SDHC card to perform updates.

12 Fan connector

A connector to attach the fan unit.

Driver Unit

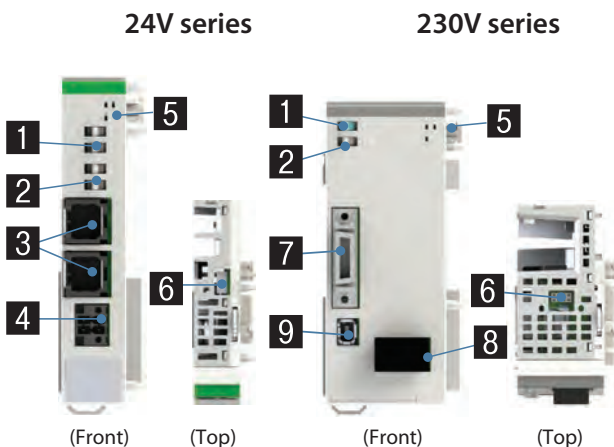

1 Jog switch

A switch used for jog operations.

2 Brake release switch

The forced brake release switch.
(On NOM side during normal operation.)

3 MPG connector

A connector to connect the motor encoder cable for actuators equipped with a 24V pulse motor, AC servo motor, or DC brush-less motor.

4 Drive source shutoff connector

A connector that allows for drive power shutoff input for each actuator.

5 Status LED

Represents the state of the controller.

6 Fan connector

A connector to attach the fan unit.

7 Encoder connector

Connects the 230V actuator encoder cable.

8 Motor connector

Connects the 230V actuator motor cable.

9 Driver stop connector

Shuts off power supply to the motor in the internal circuit.

EC connection unit

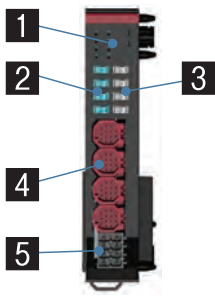

1 Status LED

Represents the state of the controller.

2 Jog switch

A switch used for jog operations.

3 Brake release switch

The forced brake release switch. (On NOM side during normal operation.)

4 EC connector

A connector to connect to EleCylinder. (with ACR option only.)

5 Drive source shutoff connector

A connector that allows for drive power shutoff input for each actuator.

Power supply unit

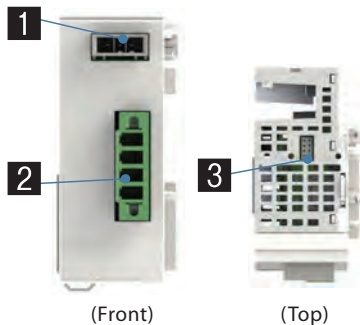

(Front)

(Top)

1 External regenerative resistance connector

A connector to connect to an external regenerative resistance unit.

2 230VAC input connector

A connector for three-phase/single-phase 230VAC.

3 Fan connector

A connector to connect the fan unit.

Expansion unit

RCON-EXT-NP/PN

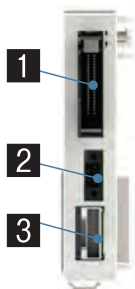

RCON-NP/PN



RCON-EXT



1 PIO cable connector

A connector for expansion PIO.

2 SIO cable connector

A connector for expansion communication.

3 SCON cable connector

A connector to connect an interface cable to connect to SCON.

Simple absolute unit

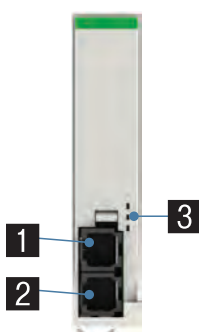

1 Actuator cable connector

A connector to connect to the actuator.

2 Driver cable connector

A connector to connect to the driver unit.

3 Status LED

Represents the state of the battery.

Touch panel teaching pendant

■ **Features** A teaching device equipped with functions such as position teaching, trial operation, and monitoring.

■ **Model TB-03-** Please contact IAI for the current supported versions.

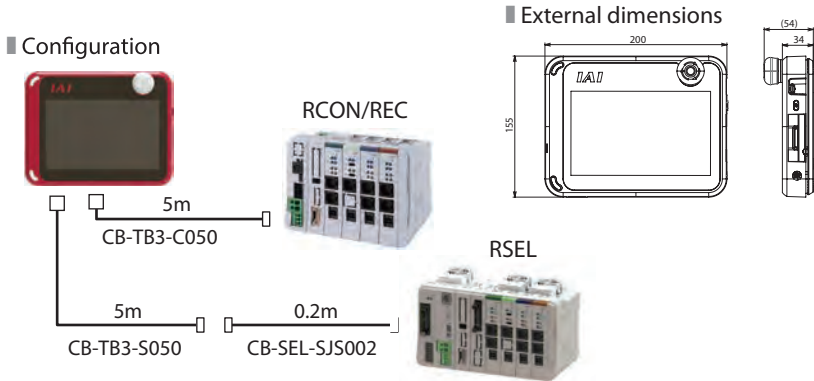

■ **Specifications**

Rated voltage	24VDC
Power consumption	3.6W or less (150mA or less)
Ambient operating temperature	0~40°C
Ambient operating humidity	20~85% RH (non-condensing)
Environmental resistance	IPX0
Mass	670g (TB-03 unit only)
Charging method	Wired connection with dedicated AC adapter/ controller
Wireless connection	Bluetooth4.2 class2

■ **Model TB-02(D)-** Please contact IAI for the current supported versions.

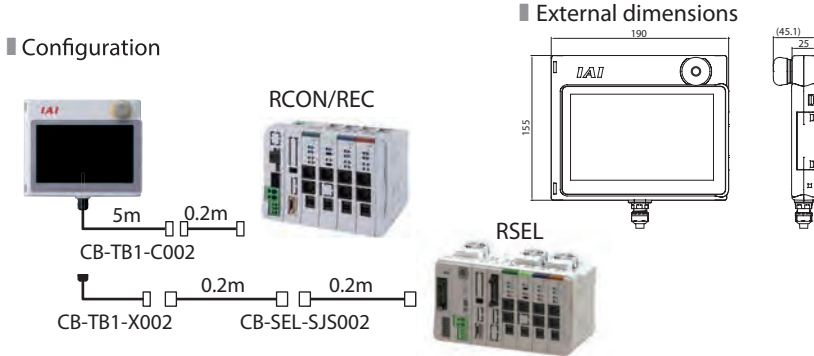

■ **Specifications**

Rated voltage	24VDC
Power consumption	3.6W or less (150mA or less)
Ambient operating temperature	0~40°C
Ambient operating humidity	20~85% RH (non-condensing)
Environmental resistance	IP20
Mass	470g (TB-02 unit only)

PC Teaching Software (Windows only)

■ **Features** Start-up support software which comes equipped with functions such as position/program teaching, trial operation, and monitoring.

For RCON/REC

■ **RC/EC PC Software** Please contact IAI for the current supported versions.

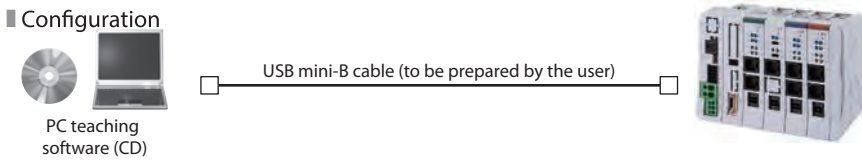

Supported Windows versions: 7/8/8.1/10



■ **Model RCM-101-USB** Please contact IAI for the current supported versions.

(with an external device communication cable + USB conversion adapter + USB cable)

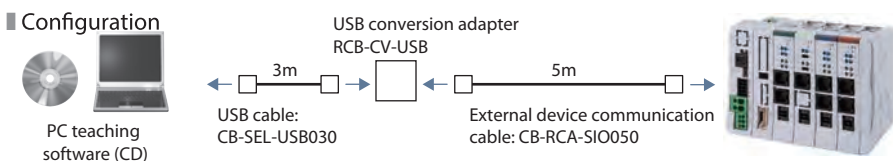

Supported Windows versions: 7/8/8.1/10



For RSEL

IA PC Software

- Features** PC teaching software only.
If you want to connect both the controller and PC side with a USB cable or Ethernet cable, only the software needs to be purchased. A cable that meet the following specifications is to be prepared by the customer.

Notes
When operating the actuator by USB connection, be sure to connect the stop switch to the system I/O connector.

- Configuration** Please contact IAI for the current supported versions.

	Controller side connector	Maximum cable length
USB cable specification	USB Mini-B	5m
Ethernet cable specification*	10/100/1000BASE-T (RJ-45)	5m

Supported Windows versions:
7/8/8.1/10

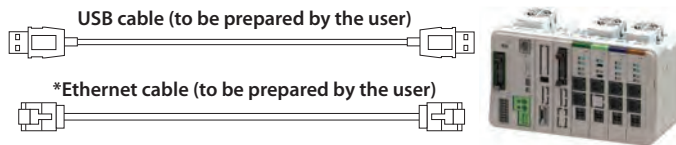

* In order to use EtherNet cable, parameters need to be set by other cables of IA-101-X-MW-JS or USB mini-B.



Model IA-101-X-MW-JS (With RS232C cable + connector conversion cable)

- Configuration** Please contact IAI for the current supported versions.

Supported Windows versions:
7/8/8.1/10

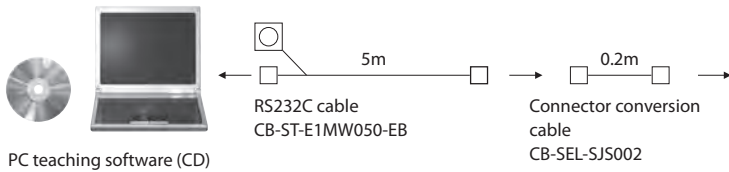

CB-ST-E1MW050-EB cannot be used "when building an enable system using an external power supply using the system I/O connector" or "when building a duplex safety circuit". (The use of CB-ST-A2MW050-EB is required.)

Model IA-101-XA-MW (With RS232C cable) * Compliant with safety category 4

- Configuration** Please contact IAI for the current supported versions.

Supported Windows versions:
7/8/8.1/10

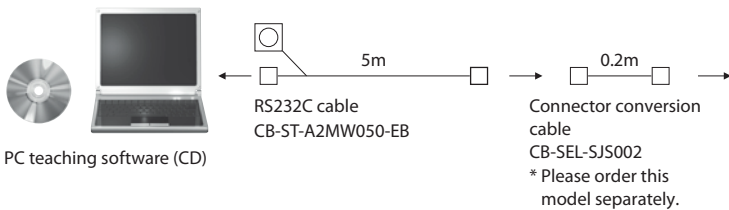

24 VDC power supply

Coming soon

- Overview** The recommended power supply for connection to R-units. The power supply is the same height as RCON and can be easily installed on control panels. It can also be connected to R-units to monitor power status.

- Model PSA-24 (without fan)**

- Model PSA-24L (with fan)**

- External dimensions**

PSA-24

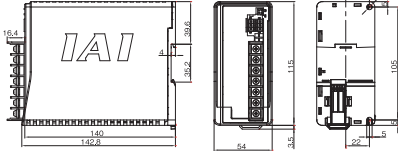

PSA-24L

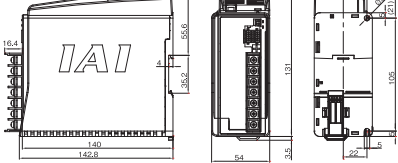

Specifications Table

Item	Specification	
	115VAC input	230VAC input
Power input voltage range	100VAC~230VAC ±10%	
Input power supply current	3.9A or less	1.9A or less
Power capacity	Without fan: 250VA With fan: 390VA	Without fan: 280VA With fan: 380VA
Inrush current ^{*1}	Without fan: 17A (typ) With fan: 27.4A (typ)	Without fan: 34A (typ) With fan: 54.8A (typ)
Generated heat	28.6W	20.4W
Output voltage range ^{*2}	24V ±10%	
Continuous rated output	Without fan: 8.5A (204W), with fan: 13.8A (330W)	
Peak output	17A(408W)	
Efficiency	86% or more	90% or more
Parallel connection ^{*3}	Max.: 5 units	

*1 The pulse width of flowing inrush current is less than 5ms.

*2 In order to enable parallel operation, this power supply can vary the output voltage according to the load. Therefore, the power supply unit is dedicated for IAI controllers.

*3 Parallel connection cannot be used under the following conditions.

- Parallel connection of PSA-24 (specification without fan) and PSA-24L (specification with fan)
- Parallel connection with a power supply unit other than this power supply

DC power supply for driving motors

- Features** This unit supplies DC power for driving the 230V specification EleCylinder. One unit can supply power for up to 6 axes. (Within the max. connectable wattage)

- Model PSA-200-2**

(Input voltage: Single phase AC230V, Max. 1600W connectable)

- External dimensions**

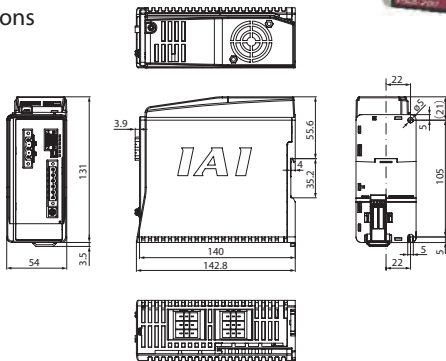

Specifications

Power input voltage range	Single phase AC230V specification: AC200 - 230V ±10%	
Input frequency range	50Hz ±5%	
Rush current (Note 1)	55°C	Control power: 60A Motor power: 70A
Output voltage	DC280V typ	
Max. motor connectable wattage	Input voltage: Single phase AC230V, Max. 1600W	
Max. number of drivable axes	6 axes	
Momentary power failure resistance	50Hz: 20ms, 60Hz: 16ms	
Withstand voltage	AC1500V between primary and FG, for 1 minute	
Insulation resistance	DC500V between secondary and FG, 10Ω or higher	
Leak current	Total 3.1 mA (when a recommended noise filter is used and 6 axes are connected)	
Electric shock protection mechanism	Class 1 Basic insulation	

(Note 1) Rush current flows for approx. 20ms after turning on the power. Be aware that the rush current varies according to the power line impedance and internal element temperature (thermistor).

Maintenance Parts

Fan unit

- Overview** This is an option to forcibly cool down the driver unit.

- Model RCON-FU**



For 230V driver

- Model RCON-FUH**



Connector conversion cable

- Features** Converts a touch panel teaching pendant or RS232C cable D-sub 25-pin connector to an RSEL teaching connector. (TB-02/TB-03-S, IA-101-X-MW-JS accessory.)

- Model CB-SEL-SJS002**



Dummy plug

For RCON-GWG

■ Model **DP-5**



For 230V driver

■ Model **DP-6**



For RSEL

■ Model **DP-4S**



System I/O connector

■ Overview A connector for emergency stop input, operation mode switching input from exterior, etc.

For RCON-GW(G)

■ Model **DFMC1,5/5-ST-3,5**

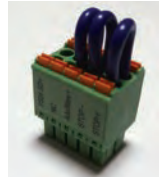

For RSEL

■ Model **DFMC1,5/8-ST-3,5 (RSEL)**

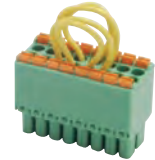

Drive source shutoff connector

■ Overview A drive source shutoff input connector.

For 24V driver

■ Model **DFMC1,5/2-STF-3,5**



For EC connection unit

■ Model **DFMC1,5/4-ST-3,5 (REC)**



230V power supply connector

For 230V power supply

■ Model **SPC5/4-STF-7,62**



Terminal connector

■ Overview Required as a terminal resistor when connecting SCON.

■ Model **RCON-EXT-TR**



Expansion SIO port connector

For PIO/SIO/SCON connection

■ Model **FMC1,5/3-STF-3,5**



Replacement battery

■ Overview A replacement battery for the simple absolute unit.

■ Model **AB-7**



Regenerative resistance unit

■ Overview A unit that converts to heat the regenerative current generated when the motor decelerates. The 230V driver unit and 230V power supply unit are equipped with regenerative resistance inside. However, when energy generates at the same time, external regenerative resistance units are necessary.

■ Model **RESU-2** (standard specification)/
RESUD-2 (DIN rail mounting specification)

■ External dimensions
<RESU-2>

<RESUD-2>

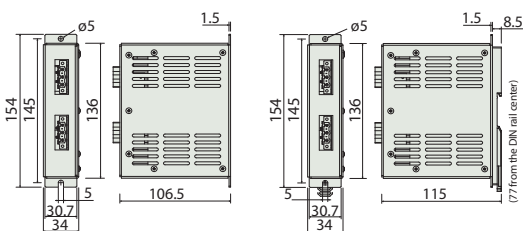

Specifications

Model	RESU-2	RESUD-2
Mass	approx. 0.4kg	
Internal regenerative resistance value	235Ω 80W	
Mounting method	Screw mount	DIN rail mount
Supplied cable	CB-SC-REU010	



*When two regenerative units are required, please use one RESU-2 and one RESU-1 (please contact IAI for the details).

When placing an order for a replacement cable, please use the model name shown below.

Table of compatible cables

Motor encoder cable for 24V driver connection

No.	Actuator		Applicable controller symbol	Connection cable ^(Note 2)		Wiring fig.
	Series	Type		Integrated motor-encoder cable (-RB: Robot cable) [Actuator connection cables]	Conversion unit	
(1)	RCP6 RCP6CR RCP6W	Other than high thrust type ^(Note 1)	P5	CB-ADPC-MPA□□□(-RB)	-	A
(2)	RCP5 RCP5CR RCP5W	High thrust type ^(Note 1)	P6	CB-ADPC-MPA□□□(-RB) CB-CAN-AJ002 (conversion cable)	-	B
(3)		Gripper (GRS/GRL), ST4525E, SA3/RA3	P5	CB-ADPC-MPA□□□(-RB)	-	A
(4)	RCP4 RCP4CR RCP4W	High thrust type ^(Note 1)	P6	CB-ADPC-MPA□□□(-RB) CB-CAN-AJ002 (conversion cable)	-	B
(5)		Other than (3), (4)	P5	CB-ADPC-MPA□□□(-RB) CB-CAN-AJ002 (conversion cable)	-	B
(6)	RCP3		P5	CB-RCAPC-MPA□□□(-RB)	-	C
(7)		RCP2 (standard type) rotary compact type RCP2-RTBS/RTBSL/RTCS/RTCSL	P5	CB-ADPC-MPA□□□(-RB) [CB-RPSEP-MPA□□□]	Required	D
(8)		RCP2CR (clean room type), RCP2W (dust-proof/splash-proof type) Rotary (RT*) of above types GRS/GRM/GR3SS/GR3SM of above types	P5	CB-ADPC-MPA□□□(-RB)	-	A
(9)	RCP2 RCP2CR RCP2W	GRSS/GRLS/GRST/GRHM/GRHB of all types (standard / clean room / dust-proof/splash-proof) Short type (RCP2 only) RCP2-SRA4R/SRGS4R/SRGD4R	P5	CB-RCAPC-MPA□□□(-RB)	-	C
(10)		High thrust type ^(Note 1)	P6	CB-ADPC-MPA□□□(-RB) [CB-CFA-MPA□□□(-RB)]	Required	D
(11)		Other than (7)~(10)	P5	CB-ADPC-MPA□□□(-RB) [CB-PSEP-MPA□□□]	Required	D
(12)	RCA2/RCA2CR/RCA2W		A6	CB-RCAPC-MPA□□□(-RB)	-	C
(13)	RCA2/RCA2CR/RCA2W (CNS option)		A6	CB-ADPC-MPA□□□(-RB)	-	A
(14)	RCA RCACR RCAW	Short type (RCA only) RCA-SRA4R/SRGS4R/SRGD4R	A6	CB-RCAPC-MPA□□□(-RB)	-	C
(15)		Other than (14)	A6	CB-ADPC-MPA□□□(-RB) [CB-ASEP2-MPA□□□]	Required	D
(16)	RCD	RCD-RA1DA, RCD-GRSNA	D6	CB-ADPC-MPA□□□(-RB)	-	A
(17)	WU		PM2	CB-ADPC-MPA□□□(-RB)	-	A

Note 1: An actuator that uses a high thrust pulse motor (56SP, 60P, 86P)

Note 2: Up to 20m from each driver unit to the actuator, with or without the conversion unit.

Note that the maximum length from the driver unit to the RCD actuator will be 10m.

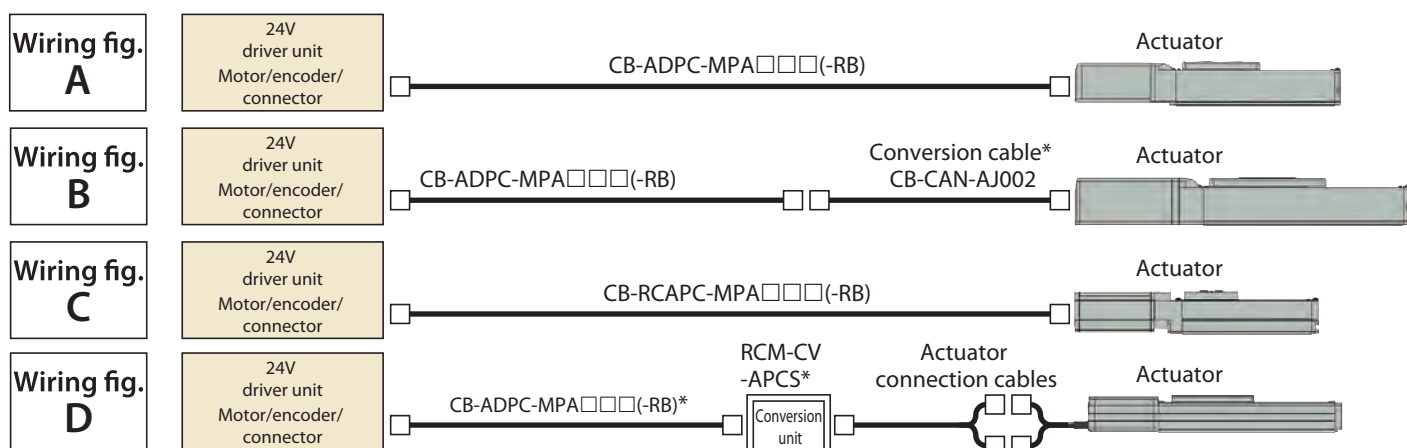

* Not supplied even if the cable length is specified in the actuator model name. Must be prepared even if the model name is specified separately.

Motor encoder cable for 230V driver connection

No.	Actuator		Applicable controller code	Connection cable ^(Note 3)			
	Series	Type		Motor cable	Motor robot cable / EU motor robot cable	Encoder cable	Encoder robot cable / EU encoder robot cable
(1)	RCS4 RCS4CR		T4	CB-RCC1-MA□□□□	CB-X2-MA□□□□ / CB-XEU1-MA□□□□	-	CB-X1-PA□□□□ / CB-XEU1-PA□□□□
(2)	RCS3(P) RCS3(P)CR	CTZ5C CT8C	T4	CB-RCC1-MA□□□□	CB-X2-MA□□□□ / CB-XEU1-MA□□□□	-	CB-X1-PA□□□□ / CB-XEU1-PA□□□□
(3)		Other than (2)	T4	CB-RCC1-MA□□□□	CB-X2-MA□□□□ / (*1)	CB-RCS2-PA□□□□	CB-X3-PA□□□□ / (*2)
(4)	RCS2 RCS2CR	RTC□L RT6	T4	CB-RCC1-MA□□□□	CB-X2-MA□□□□ / CB-XEU1-MA□□□□	CB-RCS2-PLA□□□□	CB-X2-PLA□□□□ / CB-XEU2-PLA□□□□
(5)	RCS2W	Other than (4)	T4	CB-RCC1-MA□□□□	CB-X2-MA□□□□ / (*1)	CB-RCS2-PA□□□□	CB-X3-PA□□□□ / (*2)
(6)		RA13R				CB-RCS2-PLA□□□□	CB-X2-PLA□□□□ / (*3)
(7)	RCS2	No load cell RA13R with brake (with brake box)	T4	CB-RCC1-MA□□□□	CB-X2-MA□□□□ / CB-XEU1-MA□□□□	[Actuator to brake box] CB-RCS2-PLA□□□□ [Brake box to controller] CB-RCS2-PLA□□□□	[Actuator to brake box] CB-X2-PLA□□□□ / CB-XEU2-PLA□□□□ [Brake box to controller] CB-X2-PLA□□□□ / CB-XEU2-PLA□□□□
(8)		RA13R with brake (without brake box)				[Actuator to brake box] CB-RCS2-PLA□□□□	[Actuator to brake box] CB-X2-PLA□□□□ / CB-XEU2-PLA□□□□
(9)	IS(P)B IS(P)DB IS(P)DBCR	Other than (10)	T4	-	CB-X2-MA□□□□ / CB-XEU1-MA□□□□	-	CB-X1-PA□□□□ / (*4) *Use the following cable for a cable length of 21m or greater CB-X1-PA□□□□-AWG24 / (*5)
(10)		(Option: When limit switch was selected)	T4	-	CB-X2-MA□□□□ / CB-XEU1-MA□□□□	-	CB-X1-PLA□□□□ / (*6) *Use the following cable for a cable length of 21m or greater CB-X1-PLA□□□□-AWG24 / (*7)
(11)	IS(P)A IS(P)DA IS(P)DACR SSPA	Other than (12)	T4	-	CB-X2-MA□□□□ / CB-XEU1-MA□□□□	-	CB-X1-PA□□□□ / CB-XEU1-PA□□□□
(12)	SSPDACR IF FS RS	(Option: When limit switch was selected)	T4	-	CB-X2-MA□□□□ / CB-XEU1-MA□□□□	-	CB-X1-PLA□□□□ / CB-XEU1-PLA□□□□
(13)	NSA		T4	-	CB-X2-MA□□□□ / (*1)	-	CB-X1-PA□□□□ / (*4)
(14)		Other than (15)	T4	-	CB-X2-MA□□□□ / (*1)	-	CB-X3-PA□□□□ / (*2)
(15)	NS	(Option: When limit switch was selected)	T4	-	CB-X2-MA□□□□ / CB-XEU1-MA□□□□	-	CB-X2-PLA□□□□ / CB-XEU2-PLA□□□□
(16)	DD DDCR	T18□ LT18□	T4	-	CB-X2-MA□□□□ / CB-XEU1-MA□□□□	-	CB-X3-PLA□□□□ / CB-XEU3-PLA□□□□
(17)	DDW DDA DDACR	H18□ LH18□	T4	-	CB-XMC1-MA□□□□ / CB-XEUMC1-MA□□□□	-	CB-X3-PLA□□□□ / CB-XEU3-PLA□□□□
(18)	ISWA ISPWA		T4	-	CB-XEU1-MA□□□□	-	CB-X1-PA□□□□-WC

Note 3: The max. cable length between each driver and actuator differs depending on the series.
Refer to the cable length table in respective actuator pages for details.

Communication cable

Name	Model
SCON connection cable (for RCON-EXT connection)	CB-RE-CTL□□□□
PIO flat cable (for RSEL, expansion PIO connection)	CB-PAC-PIO□□□□
Power/communication cables for RCON-EC	CB-REC-PWBIO□□□□-RB
Power/communication cables for RCON-EC (4-way connector)	CB-REC2-PWBIO□□□□-RB

Motor power cable for 230V specification EleCylinder

Name	Model
Motor power cable for EC-S10(X)/S13(X)/S15(X) etc.	CB-EC-PW□□□□-RB

- (*1) CB-XEU1-MA□□□□ (EU version with plastic round connector)
- (*2) CB-XEU3-PA□□□□ (EU version with metal round connector)
- (*3) CB-XEU2-PLA□□□□ (EU version with metal round connector)
- (*4) CB-XEU1-PA□□□□ (EU version with metal round connector)
- (*5) CB-XEU1-PA□□□□-AWG24 (EU version with metal round connector)
- (*6) CB-XEU1-PLA□□□□ (EU version with metal round connector)
- (*7) CB-XEU1-PLA□□□□-AWG24 (EU version with metal round connector)

Model **CB-ADPC-MPA** / **CB-ADPC-MPA**-RB

*Please indicate the cable length (L) in □□□, e.g.) 030 = 3m, maximum 20m

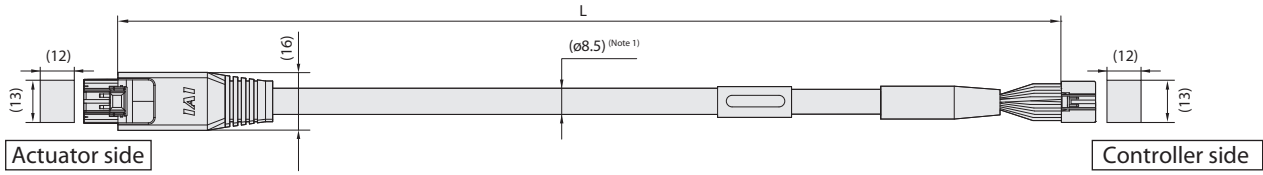

Minimum bending radius R
 5m or less
 More than 5m
 r = 68mm or more (Dynamic bending condition)
 r = 73mm or more (Dynamic bending condition)

* The robot cable is designed for flex-resistance: Please use the robot cable if the cable needs to be installed through the cable track.

(Note 1) If the cable length is over 5m, ø9.1 cable diameter applies.

DF62DL-24S-2.2C (HIROSE ELECTRIC CO., LTD.)					DF62DL-24S-2.2C (HIROSE ELECTRIC CO., LTD.)				
Color (Standard cable) *	Signal name			Pin No.	Pin No.	Signal name			Color (Standard cable) *
	DC	AC	PC			PC	AC	DC	
Blue (AWG22/19)	U	U	øA	3	3	øA	U	U	Blue (AWG22/19)
Orange (AWG22/19)	V	V	VMM	5	5	VMM	V	V	Orange (AWG22/19)
Brown (AWG22/19)	-	-	øB	10	10	øB	-	-	Brown (AWG22/19)
Gray (AWG22/19)	-	-	VMM	9	9	VMM	-	-	Gray (AWG22/19)
Green (AWG22/19)	W	W	ø_A	4	4	ø_A	W	W	Green (AWG22/19)
Red (AWG22/19)	-	-	ø_B	15	15	ø_B	-	-	Red (AWG22/19)
Light blue (AWG26)	A+	A+	SA[mABS]	12	12	SA[mABS]	A+	A+	Light blue (AWG26)
Orange (AWG26)	A-	A-	SB[mABS]	17	17	SB[mABS]	A-	A-	Orange (AWG26)
Green (AWG26)	B+	B+	A+	1	1	A+	B+	B+	Green (AWG26)
Brown (AWG26)	B-	B-	A-	6	6	A-	B-	B-	Brown (AWG26)
Gray (AWG26)	HS1_IN	Z+/SA[mABS]	B+	11	11	B+	Z+/SA[mABS]	HS1_IN	Gray (AWG26)
Red (AWG26)	HS2_IN	Z-/SB[mABS]	B-	16	16	B-	Z-/SB[mABS]	HS2_IN	Red (AWG26)
Black (AWG26)	-	VPS/BAT-	VPS	18	18	VPS	VPS/BAT-	-	Black (AWG26)
Yellow (AWG26)	-	BK+	LS+	8	8	LS+	BK+	-	Yellow (AWG26)
Light blue (AWG26)	-	LS+	BK+	20	20	BK+	LS+	-	Light blue (AWG26)
Orange (AWG26)	-	LS-	BK-	2	2	BK-	LS-	-	Orange (AWG26)
Gray (AWG26)	VCC	VCC	VCC	21	21	VCC	VCC	VCC	Gray (AWG26)
Red (AWG26)	GND	GND	GND	7	7	GND	GND	GND	Red (AWG26)
Brown (AWG26)	-	BK-	LS-	14	14	LS-	BK-	-	Brown (AWG26)
Green (AWG26)	HS3_IN	LS_GND	LS_GND	13	13	LS_GND	LS_GND	HS3_IN	Green (AWG26)
-	-	-	-	19	19	-	-	-	-
Pink (AWG26)	-	BAT+	CF_VCC	22	22	CF_VCC	BAT+	-	Pink (AWG26)
-	-	-	-	23	23	-	-	-	-
Black (AWG26)	FG	FG	FG	24	24	FG	FG	FG	Black (AWG26)

* For color of robot cable please refer to the manual.

Model **CB-RCAPC-MPA** / **CB-RCAPC-MPA**-RB

*Please indicate the cable length (L) in □□□, e.g.) 030 = 3m, maximum 20m

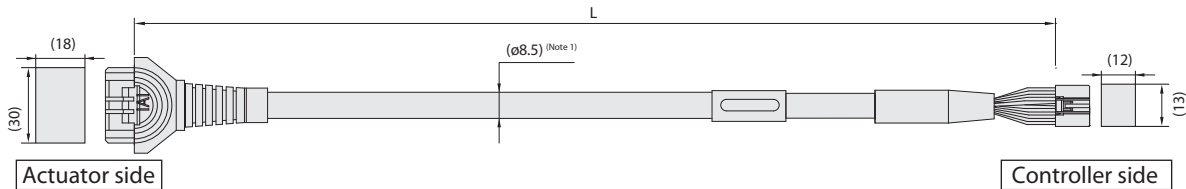

Minimum bending radius R
 3m or less
 More than 3m
 r = 68mm or more (Dynamic bending condition)
 r = 73mm or more (Dynamic bending condition)

* The robot cable is designed for flex-resistance: Please use the robot cable if the cable needs to be installed through the cable track.

(Note 1) If the cable length is over 3m, ø9.1 cable diameter applies.

1-1827863-1 (AMP)					DF62DL-24S-2.2C (HIROSE ELECTRIC CO., LTD.)				
Color (Standard cable) *	Signal name			Pin No.	Pin No.	Signal name			Color (Standard cable) *
	DC	AC	PC			PC	AC	DC	
Blue (AWG22/19)	U	U	øA	A1	3	øA	U	U	Blue (AWG22/19)
Orange (AWG22/19)	V	V	VMM	B1	5	VMM	V	V	Orange (AWG22/19)
Brown (AWG22/19)	-	-	øB	B2	10	øB	-	-	Brown (AWG22/19)
Gray (AWG22/19)	-	-	VMM	A3	9	VMM	-	-	Gray (AWG22/19)
Green (AWG22/19)	W	W	ø_A	A2	4	ø_A	W	W	Green (AWG22/19)
Red (AWG22/19)	-	-	ø_B	B3	15	ø_B	-	-	Red (AWG22/19)
Light blue (AWG26)	A+	A+	SA[mABS]	A6	12	SA[mABS]	A+	A+	Light blue (AWG26)
Orange (AWG26)	A-	A-	SB[mABS]	B6	17	SB[mABS]	A-	A-	Orange (AWG26)
Green (AWG26)	B+	B+	A+	A7	1	A+	B+	B+	Green (AWG26)
Brown (AWG26)	B-	B-	A-	B7	6	A-	B-	B-	Brown (AWG26)
Gray (AWG26)	HS1_IN	Z+/SA[mABS]	B+	A8	11	B+	Z+/SA[mABS]	HS1_IN	Gray (AWG26)
Red (AWG26)	HS2_IN	Z-/SB[mABS]	B-	B8	16	B-	Z-/SB[mABS]	HS2_IN	Red (AWG26)
Black (AWG26)	-	VPS/BAT-	VPS	B9	18	VPS	VPS/BAT-	-	Black (AWG26)
Yellow (AWG26)	-	BK+	LS+	A4	8	LS+	BK+	-	Yellow (AWG26)
Light blue (AWG26)	-	LS+	BK+	A5	20	BK+	LS+	-	Light blue (AWG26)
Orange (AWG26)	-	LS-	BK-	B5	2	BK-	LS-	-	Orange (AWG26)
Gray (AWG26)	VCC	VCC	VCC	A10	21	VCC	VCC	VCC	Gray (AWG26)
Red (AWG26)	GND	GND	GND	B10	7	GND	GND	GND	Red (AWG26)
Brown (AWG26)	-	BK-	LS-	B4	14	LS-	BK-	-	Brown (AWG26)
Green (AWG26)	HS3_IN	LS_GND	LS_GND	A9	13	LS_GND	LS_GND	HS3_IN	Green (AWG26)
-	-	-	-	A11	19	-	-	-	-
-	-	-	-	-	22	CF_VCC	BAT+	-	Gray (AWG26)
-	-	-	-	-	23	-	-	-	-
Black (AWG26)	FG	FG	FG	B11	24	FG	FG	FG	Black (AWG26)

* For color of robot cable please refer to the manual.

Model **CB-RPSEP-MPA** □□□

* Only the robot cable is available for this model.

* Please indicate the cable length (L) in □□□, e.g.) 080 = 8m, maximum 20m

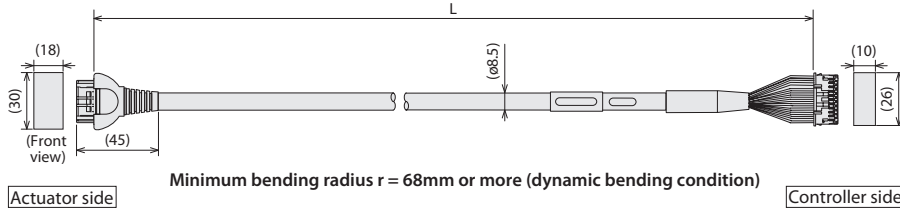

Actuator side D-1100D 1-1827863-1 (AMP)		Controller side PADP-24V-1-5 (J.S.T. Mfg. Co.,Ltd.)	
Terminal number		Terminal number	
A1	Black [øA]	1	1
B1	White [VMM]	2	2
A2	Brown [øA]	3	3
B2	Green [øB]	4	4
A3	Yellow [VMM]	5	5
B3	Red [øB]	6	6
A6	Orange [LS+]	7	7
B6	Gray [LS-]	8	8
A7	Red [A+]	9	9
B7	Green [A-]	10	10
A8	Black [B+]	11	11
B8	Brown [B-]	12	12
A4	NC	13	13
B4	NC	14	14
A5	Black (identification tape) [BK+]	15	15
B5	Brown (identification tape) [BK-]	16	16
A9	Green (identification tape) [GNLS]	17	17
B9	Red (identification tape) [VPS]	18	18
A10	White (identification tape) [VCC]	19	19
B10	Yellow (identification tape) [GND]	20	20
A11	NC	21	21
B11	Shield [FG] (FG)	22	22
	NC	23	23

Model **CB-CFA-MPA** □□□/ **CB-CFA-MPA** □□□-RB

* Please indicate the cable length (L) in □□□, e.g.) 080 = 8m, maximum 20m

If the cable length is over 3m, ø9.1 cable diameter applies for a non-robot cable and ø10 for a robot cable.

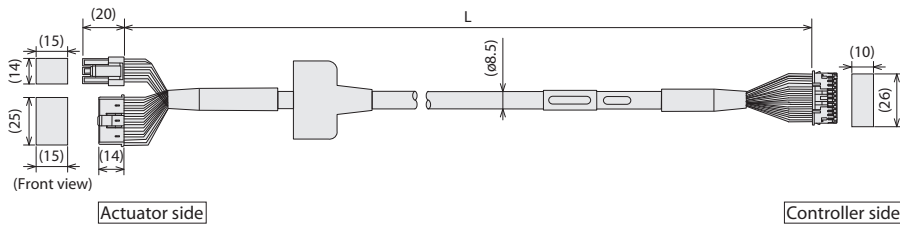

Actuator side SLP-06V (J.S.T. Mfg. Co.,Ltd.) XMP-18V (J.S.T. Mfg. Co.,Ltd.)		Controller side PADP-24V-1-5 (J.S.T. Mfg. Co.,Ltd.)	
Pin No.	Signal name	Pin No.	Signal name
1	øA	1	øA
2	VMM	2	VMM
4	øB	3	øB
5	VMM	4	VMM
3	ø/A	5	ø/A
6	ø/B	6	ø/B
5	NC	11	NC
6	NC	12	NC
13	LS+	7	LS+
14	LS-	8	LS-
1	A+	13	A+
2	A-	14	A-
3	B+	15	B+
4	B-	16	B-
16	BK+	9	BK+
17	BK-	10	BK-
12	VCC	21	VCC
9	GND	19	GND
11	VPS	18	VPS
10	NC	20	NC
18	FG	24	FG
15	NC	17	NC
7	NC	22	NC
8	NC	23	NC

* The robot cable is designed for flex-resistance:
Please use the robot cable if the cable needs to be installed through the cable track.

Model **CB-PSEP-MPA** □□□

* Only the robot cable is available for this model.

* Please indicate the cable length (L) in □□□, e.g.) 080 = 8m, maximum 20m

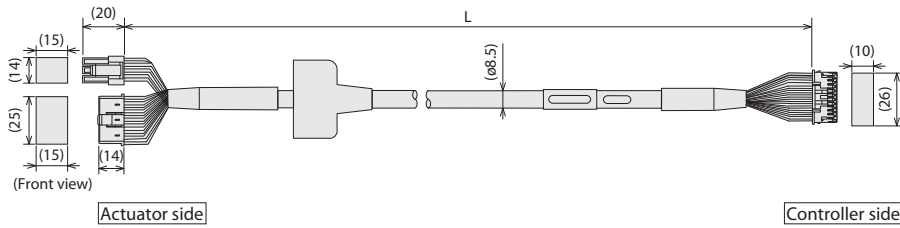

Actuator side SLP-06V (J.S.T. Mfg. Co.,Ltd.) XMP-18V (J.S.T. Mfg. Co.,Ltd.)		Controller side PADP-24V-1-5 (J.S.T. Mfg. Co.,Ltd.)	
Terminal number		Terminal number	
1	Black [øA]	1	1
2	White [VMM]	2	2
4	Red [øB]	3	3
5	Green [VMM]	4	4
3	Brown [øA]	5	5
6	Yellow [øB]	6	6
16	Orange [BK+]	9	9
17	Gray [BK-]	10	10
5	NC	11	11
13	NC	12	12
14	Black [LS+]	7	7
1	Brown [LS-]	8	8
2	White [A+]	13	13
3	Yellow [A-]	14	14
4	Red [B+]	15	15
10	Green [B-]	16	16
11	White (identification tape) [VCC]	17	17
9	Yellow (identification tape) [VPS]	18	18
12	Red (identification tape) [GND]	19	19
15	Green (identification tape) [reserve]	20	20
7	NC	21	21
8	NC	22	22
18	Shield [FG]	23	23
	NC	24	24

Model **CB-ASEP2-MPA** □□□

* Only the robot cable is available for this model.

* Please indicate the cable length (L) in □□□, e.g.) 080 = 8m, maximum 20m

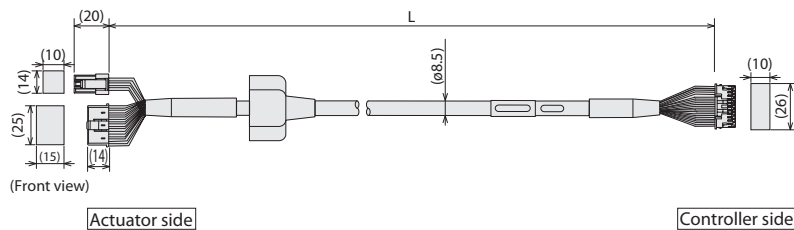

Actuator side SLP-06V (J.S.T. Mfg. Co.,Ltd.) XMP-18V (J.S.T. Mfg. Co.,Ltd.)		Controller side PADP-24V-1-5 (J.S.T. Mfg. Co.,Ltd.)	
Terminal number		Terminal number	
1	Red [U]	1	1
2	Yellow [V]	2	2
	NC	3	3
	NC	4	4
3	Black [W]	5	5
	NC	6	6
18	Orange [BK+]	7	7
17	Gray [BK-]	8	8
7	Black [LS+]	9	9
16	Brown [LS-]	10	10
1	White [A+]	11	11
2	Yellow [A-]	12	12
3	Red [B+]	13	13
4	Green [B-]	14	14
10	Black (identification tape) [Z+]	15	15
11	Brown (identification tape) [Z-]	16	16
14	White (identification tape) [VCC]	17	17
15	Yellow (identification tape) [GND]	19	19
13	Red (identification tape) [VPS/BAT-]	18	18
6	Green (identification tape) [reserve]	20	20
12	White [BAT+]	21	21
5	NC	22	22
8	NC	23	23
9	Shield [FG]	24	24

Model **CB-RCC1-MA**□□□ / **CB-X2-MA**□□□

*Please indicate the cable length (L) in □□□, e.g.) 080 = 8m, maximum 30m

Fig.: Non-EU motor standard cable CB-RCC1-MA□□□ / robot cable CB-X2-MA□□□ with flat actuator connector

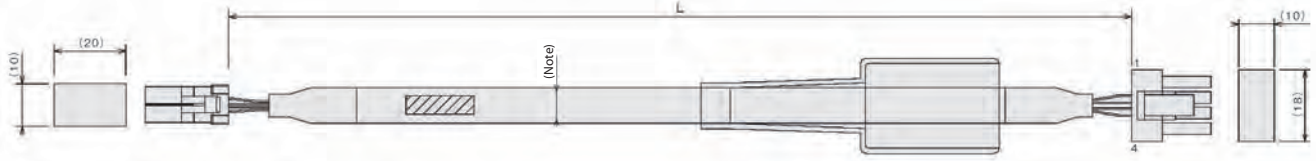

Controller side

Minimum bending radius $r = 51\text{mm}$ or more (Dynamic bending condition)

Actuator side

* Please use the robot cable if the cable needs to be installed through the cable track.

F35FDC-04V-K (J.S.T. Mfg. Co., Ltd.)

Wiring	Color	Signal	No.
0.75sq (crimped)	Red	U	B1
	White	V	B2
	Black	W	A1
	Green	PE	A2

SLP-04V (J.S.T. Mfg. Co., Ltd.)

No.	Signal	Color	Wiring
1	U	Red	0.75sq (crimped)
2	V	White	
3	W	Black	
4	PE	Green	

Model **CB-XMC1-MA**□□□ / **CB-XEUMC1-MA**□□□

*Please indicate the cable length (L) in □□□, e.g.) 080 = 8m, maximum 30m

Fig.: DD(A) high-torque type non-EU motor cable CB-XMC1-MA□□□ with flat actuator connector (for figure and pin assignment of EU cable CB-XEUMC1-MA□□□ with M18 round actuator connector please see P18 of DDA brochure)

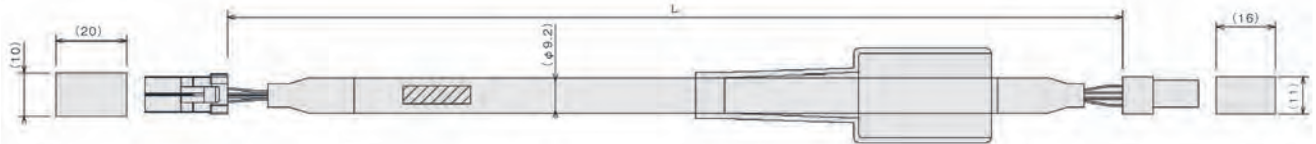

Controller side

Minimum bending radius $r = 55\text{mm}$ or more (Dynamic bending condition)

Actuator side

* Only the robot cable is available for this model.

F35FDC-04V-K (J.S.T. Mfg. Co., Ltd.)

Wiring	Color	Signal	No.
1.25sq (crimped)	Red	U	B1
	White	V	B2
	Black	W	A1
	Green	PE	A2

SLP-04V

No.	Signal	Color	Wiring
1	U	Red	1.25sq (crimped)
2	V	White	
3	W	Black	
4	PE	Green	

Model **CB-XEU1-MA**□□□

*Please indicate the cable length (L) in □□□, e.g.) 080 = 8m, maximum 30m

Fig.: EU motor robot cable with M18 round actuator connector

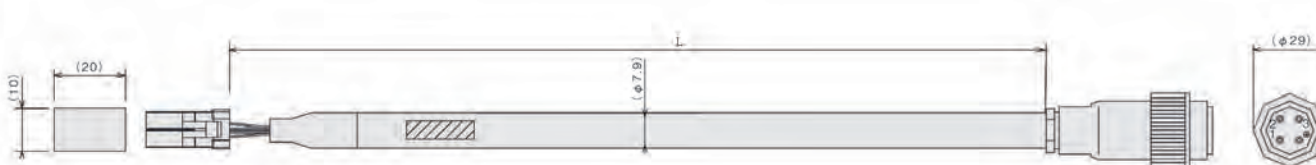

Controller side

Minimum bending radius $r = 48\text{mm}$ or more (Dynamic bending condition)

Actuator side

* Only the robot cable is available for this model.

F35FDC-04V-K (J.S.T. Mfg. Co., Ltd.)

Wiring	Color	Signal	No.
0.75sq (crimped)	1 with white character in black	U	B1
	2 with white character in black	V	B2
	3 with white character in black	W	A1
	Green/yellow	PE	A2

99-4222-00-04(binder)

No.	Signal	Color	Wiring
1	U	1 with white character in black	0.75sq (crimped)
2	V	2 with white character in black	
3	W	3 with white character in black	
⊕	PE	Green/yellow	

Model CB-RCS2-PA□□□□ / CB-X3-PA□□□□ / CB-XEU3-PA□□□□

*Please indicate the cable length (L) in □□□, e.g.) 080 = 8m, maximum 30m

Fig.: Non-EU encoder standard cable CB-RCS2-PA□□□□ / robot cable CB-X3-PA□□□□ with flat actuator connector (for figure and pin assignment of EU cable CB-XEU3-PA□□□□ with metal connector please see P162 of RCS4 catalogue)

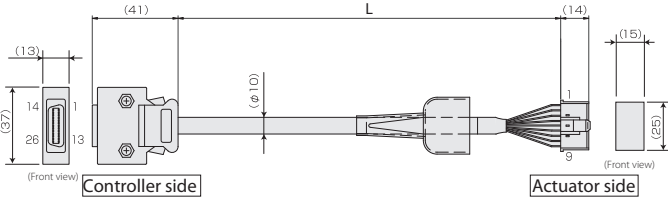

Minimum bending radius $r = 58\text{mm}$ or more (Dynamic bending condition)

* Please use the robot cable if the cable needs to be installed through the cable track.

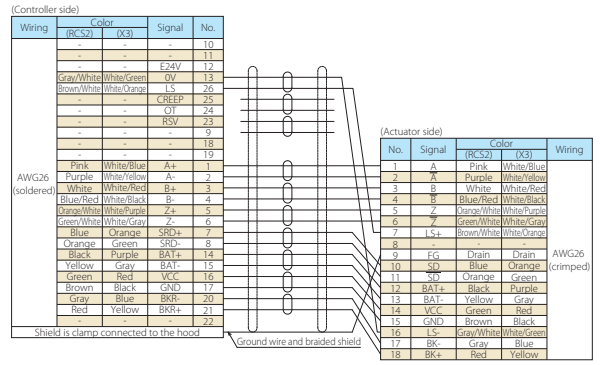

Model CB-X1-PA□□□□ / CB-XEU1-PA□□□□

*Please indicate the cable length (L) in □□□, e.g.) 080 = 8m, maximum 20m

Fig.: Non-EU encoder robot cable CB-X1-PA□□□□ with flat actuator connector (for figure and pin assignment of EU cable CB-XEU1-PA□□□□ with metal connector please see P163 of RCS4 catalogue)

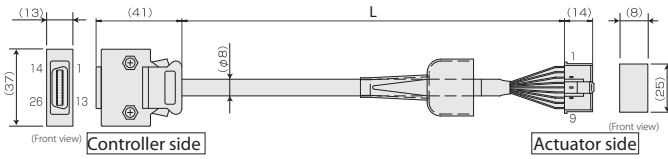

Minimum bending radius $r = 44\text{mm}$ or more (Dynamic bending condition)

* Only the robot cable is available for this model.

*If you require a cable 21m or longer for ISB/ISDB/ISDBCR/NSA (encoder type is battery-less absolute), select CB-X(EU)1-PA□□□□-AWG24.

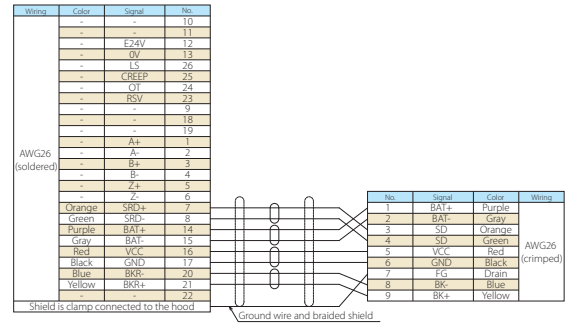

Model CB-X1-PA□□□□-AWG24 / CB-XEU1-PA□□□□-AWG24

*Please indicate the cable length (L) in □□□, e.g.) 210 = 21m, maximum 30m

Fig.: Non-EU encoder robot cable CB-X1-PA□□□□-AWG24 with flat actuator connector (for figure and pin assignment of EU cable CB-XEU1-PA□□□□-AWG24 with metal connector please see P163 of RCS4 catalogue)

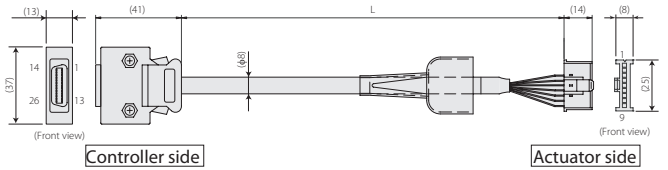

Minimum bending radius $r = 44\text{mm}$ or more (Dynamic bending condition)

* Only the robot cable is available for this model.

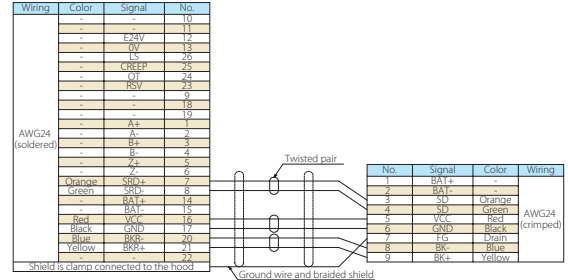

Model CB-X1-PLA□□□□ / CB-XEU1-PLA□□□□

*Please indicate the cable length (L) in □□□, e.g.) 080 = 8m, maximum 30m

Fig.: Non-EU limit switch encoder robot cable CB-X1-PLA□□□□ with flat actuator connector (for figure and pin assignment of EU cable CB-XEU1-PLA□□□□ with metal connector please see P164 of RCS4 catalogue)

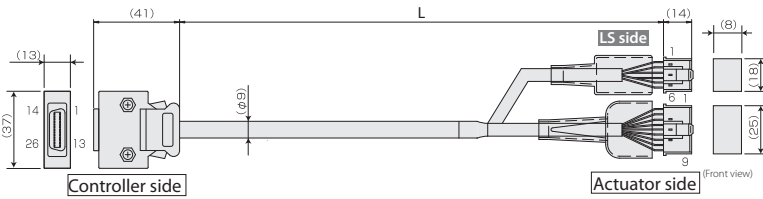

Minimum bending radius $r = 54\text{mm}$ or more (Dynamic bending condition)

* Only the robot cable is available for this model.

*If you require ISB/ISDB/ISDBCR (encoder type is battery-less absolute) with the cable of 21m or more, select the CB-X(EU)1-PLA□□□□-AWG24.

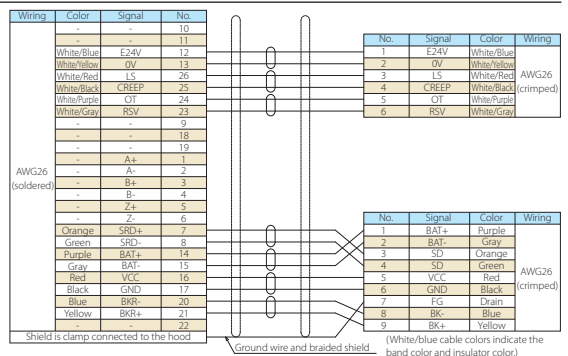

Model CB-X1-PLA□□□□-AWG24 / CB-XEU1-PLA□□□□-AWG24

*Please indicate the cable length (L) in □□□, e.g.) 210 = 21m, maximum 30m

Fig.: Non-EU limit switch encoder robot cable CB-X1-PLA□□□□-AWG24 with flat actuator connector (for figure and pin assignment of EU cable CB-XEU1-PLA□□□□-AWG24 with metal connector please see P165 of RCS4 catalogue)

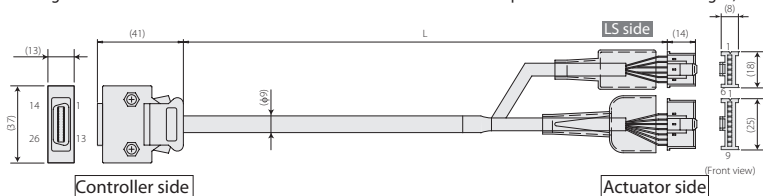

Minimum bending radius $r = 54\text{mm}$ or more (Dynamic bending condition)

* Only the robot cable is available for this model.

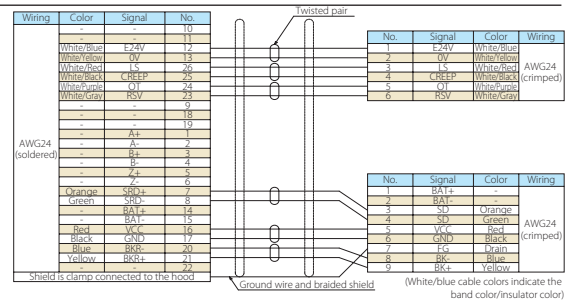

Model **CB-X2-PLA** / **CB-XEU2-PLA**

*Please indicate the cable length (L) in □□□, e.g.) 080 = 8m, maximum 30m

Fig.: Non-EU limit switch encoder robot cable CB-X2-PLA with flat actuator connector (for figure and pin assignment of EU cable CB-XEU2-PLA with metal connector please see P164 of RCS4 catalogue)

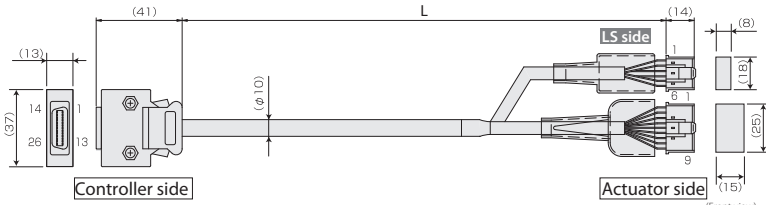

Minimum bending radius $r = 50\text{mm}$ or more (Dynamic bending condition)
 *Please use the robot cable if the cable needs to be installed through the cable track.

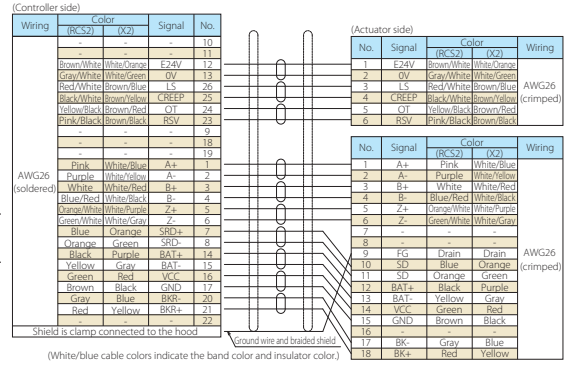

Model **CB-RE-CTL**

* Please indicate the cable length (L) in □□□, e.g.) 030 = 3m, maximum 3m

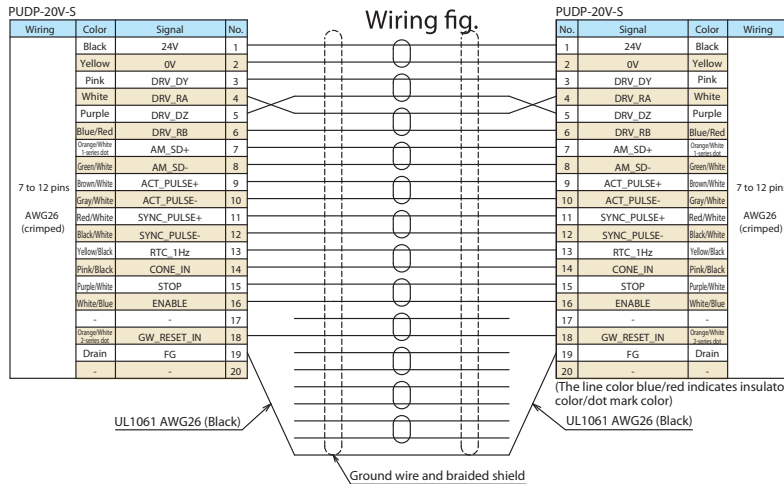
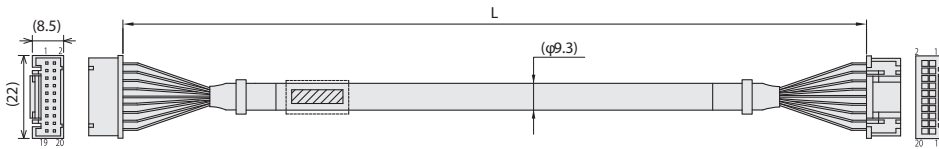

Model **CB-PAC-PIO**

*Please indicate the cable length (L) in □□□, e.g.) 080 = 8m, maximum 10m

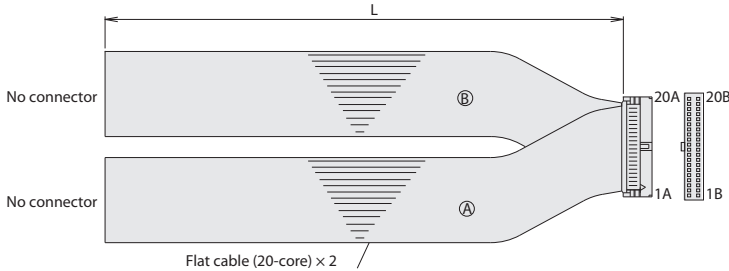

HIF6-40D-1-27R

No.	Signal name	Cable color	Wiring	No.	Signal name	Cable color	Wiring
1A	24V	Brown-1		1B	OUT0	Brown-3	
2A	24V	Red-1		2B	OUT1	Red-3	
3A	-	Orange-1		3B	OUT2	Orange-3	
4A	-	Yellow-1		4B	OUT3	Yellow-3	
5A	IN0	Green-1		5B	OUT4	Green-3	
6A	IN1	Blue-1		6B	OUT5	Blue-3	
7A	IN2	Purple-1		7B	OUT6	Purple-3	
8A	IN3	Gray-1		8B	OUT7	Gray-3	
9A	IN4	White-1		9B	OUT8	White-3	
10A	IN5	Black-1		10B	OUT9	Black-3	
11A	IN6	Brown-2		11B	OUT10	Brown-4	
12A	IN7	Red-2		12B	OUT11	Red-4	
13A	IN8	Orange-2		13B	OUT12	Orange-4	
14A	IN9	Yellow-2		14B	OUT13	Yellow-4	
15A	IN10	Green-2		15B	OUT14	Green-4	
16A	IN11	Blue-2		16B	OUT15	Blue-4	
17A	IN12	Purple-2		17B	-	Purple-4	
18A	IN13	Gray-2		18B	-	Gray-4	
19A	IN14	White-2		19B	OV	White-4	
20A	IN15	Black-2		20B	OV	Black-4	

Model **CB-REC-PWBIO**□□□-RB

*Please indicate the cable length (L) in □□□, e.g.) 030 = 3m, maximum 10m

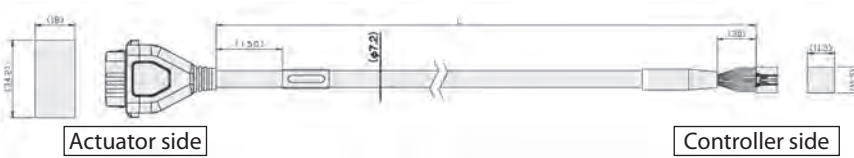

Actuator side

Controller side

Minimum bending radius $r = 58\text{mm}$ or more (Dynamic bending condition)
* Only the robot cable is available for this model.

Color	Signal name	Pin No.	Pin No.	Signal name	Color
Black (AWG18)	0V	A1	2	0V	Black (AWG18)
Red (AWG18)	24V(MP)	B1	1	24V(MP)	Red (AWG18)
Light blue (AWG22)	24V(CP)	A2	12	24V(CP)	Light blue (AWG22)
Orange (AWG26)	IN0	B3	7	OUT0	Orange (AWG26)
Yellow (AWG26)	IN1	B4	8	OUT1	Yellow (AWG26)
Green (AWG26)	IN2	B5	9	OUT2	Green (AWG26)
Pink (AWG26)	SD+	B6	6	SD+	Pink (AWG26)
White (AWG26)	SD-	A6	10	SD-	White (AWG26)
Blue (AWG26)	OUT0	A3	3	INO	Blue (AWG26)
Purple (AWG26)	OUT1	A4	4	IN1	Purple (AWG26)
Gray (AWG26)	OUT2	A5	5	IN2	Gray (AWG26)
Brown (AWG26)	BKRLS	B2	11	BKRLS	Brown (AWG26)
			13	FG	Green (AWG26)

Model **CB-REC2-PWBIO**□□□-RB

*Please indicate the cable length (L) in □□□, e.g.) 030 = 3m, maximum 10m



Actuator side

Controller side

Minimum bending radius $r = 58\text{mm}$ or more (Dynamic bending condition)
* Only the robot cable is available for this model.

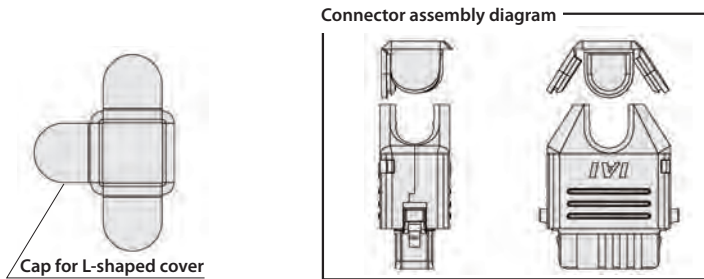

Cap for L-shaped cover

Connector assembly diagram

Color	Signal name	Pin No.	Pin No.	Signal name	Color
Black (AWG18)	0V	A1	2	0V	Black (AWG22)
Red (AWG18)	24V(MP)	B1	1	24V(MP)	Red (AWG22)
Light blue (AWG22)	24V(CP)	A2	12	24V(CP)	Light blue (AWG22)
Orange (AWG26)	INO	B3	7	OUT0	Orange (AWG26)
Yellow (AWG26)	IN1	B4	8	OUT1	Yellow (AWG26)
Green (AWG26)	IN2	B5	9	OUT2	Green (AWG26)
Yellow-Green (AWG26)	SD+	B6	6	SD+	Yellow-Green (AWG26)
Light gray (AWG26)	SD-	A6	10	SD-	Light gray (AWG26)
Blue (AWG26)	OUT0	A3	3	INO	Blue (AWG26)
Purple (AWG26)	OUT1	A4	4	IN1	Purple (AWG26)
Gray (AWG26)	OUT2	A5	5	IN2	Gray (AWG26)
Brown (AWG26)	BKRLS	B2	11	BKRLS	Brown (AWG26)
			13	FG	Green (AWG26)

Model **CB-EC-PW**□□□-RB

*Please indicate the cable length (L) in □□□, e.g.) 030 = 3m, maximum 10m

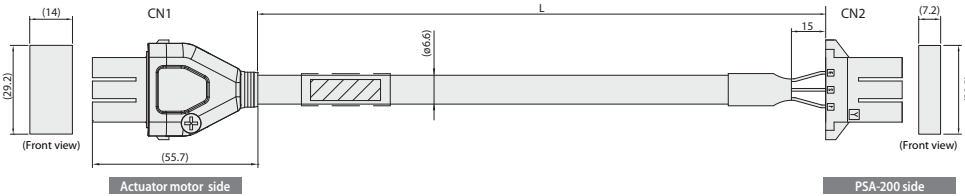

Actuator motor side

PSA-200 side

Minimum bending radius $r = 40\text{mm}$ or more (Dynamic bending condition)
* Only the robot cable is available for this model.

Color	Signal name	Pin No.	Pin No.	Signal name	Color
Red (AWG18)	MP	1	1	MP	Red (AWG18)
Black (AWG18)	MN	2	2	MN	Black (AWG18)
Green/Yellow (AWG18)	PE	3	3	PE	Green/Yellow (AWG18)

Model **CB-CAN-AJ002**

Model **RCM-CV-APCS**

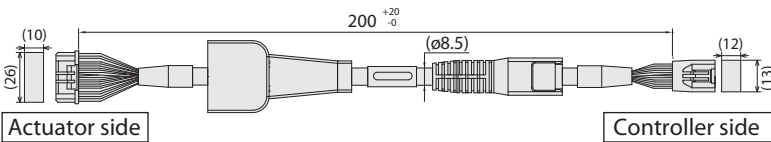

Actuator side

Controller side

Minimum bending radius $R \geq 3\text{m}$ or less $r = 68\text{mm}$ or more (Dynamic bending condition)

1-1827863-1 (AMP)					DF62B-24EP-2.2C (HIROSE ELECTRIC CO., LTD.)						
Pin No.	PC	Signal name	AC	DC	Color	Pin No.	PC	Signal name	AC	DC	Color
A1	eA	U	U		Blue (AWG22)	3	eA	U	U		Blue (AWG22)
B1	VMM	V	V		Orange (AWG22)	5	VMM	V	V		Orange (AWG22)
B2	eB	-	-		Brown (AWG22)	10	eB	-	-		Brown (AWG22)
A3	VMM	-	-		Gray (AWG22)	9	VMM	-	-		Gray (AWG22)
A2	eA	W	W		Green (AWG22)	4	eA	W	W		Green (AWG22)
B3	eB	-	-		Red (AWG22)	15	eB	-	-		Red (AWG22)
A6	SA(mABS)	A+	A+		Light blue (AWG26)	12	SA(mABS)	A+	A+		Light blue (AWG26)
B6	SB(mABS)	A-	A-		Orange (AWG26)	17	SB(mABS)	A-	A-		Green (AWG26)
A7	A+	B+	B+		Green (AWG26)	6	A-	B+	B+		Green (AWG26)
B7	A-	B-	B-		Brown (AWG26)	6	A-	B-	B-		Brown (AWG26)
A8	B+	Z+/SA(mABS)	HS1_IN		Gray (AWG26)	11	B+	Z+/SA(mABS)	HS1_IN		Gray (AWG26)
B8	B-	Z-/SB(mABS)	HS2_IN		Red (AWG26)	16	B-	Z-/SB(mABS)	HS2_IN		Red (AWG26)
B9	VPS	VPS/BAT-	-		Black (AWG26)	18	VPS	VPS/BAT-	-		Black (AWG26)
A4	LS+	BK+	-		Yellow (AWG26)	8	LS+	BK+	-		Yellow (AWG26)
A5	BK+	LS+	-		Light blue (AWG26)	20	BK+	LS+	-		Light blue (AWG26)
B5	BK-	LS-	-		Orange (AWG26)	2	BK-	LS-	-		Orange (AWG26)
A10	VCC	VCC	VCC		Gray (AWG26)	21	VCC	VCC	VCC		Gray (AWG26)
B10	GND	GND	GND		Red (AWG26)	7	GND	GND	GND		Red (AWG26)
B4	LS-	BK	-		Brown (AWG26)	14	LS-	BK	-		Brown (AWG26)
A9	LS_GND	LS_GND	HS3_IN		Green (AWG26)	13	LS_GND	LS_GND	HS3_IN		Green (AWG26)
A11	-	-	-		-	19	-	-	-		-
B11	FG	FG	FG		Black (AWG26)	22	CF_VCC	BAT+	-		Gray (AWG26)
						23	-	-	-		-
						24	FG	FG	FG		Black (AWG26)

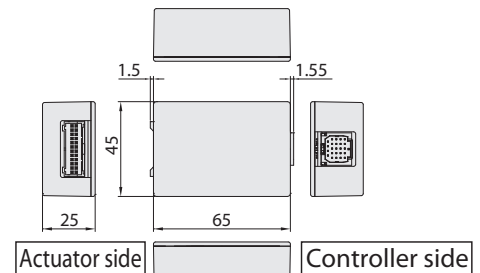

Actuator side

Controller side

**R-unit Series V2
Catalogue No. 0122-E**

The information contained in this catalog is subject to change without notice for the purpose of product improvement



IAI Industrieroboter GmbH
Ober der Röth 4
D-65824 Schwalbach / Frankfurt
Germany
Tel.: +49-6196-8895-0
Fax: +49-6196-8895-24
E-Mail: info@IAI-automation.com
Internet: IAI-automation.com

IAI America, Inc.

2690 W. 237th Street, Torrance, CA 90505, U.S.A
Phone: +1-310-891-6015, Fax: +1-310-891-0815

IAI (Shanghai) Co., Ltd

Shanghai Jiahua Business Center A8-303, 808,
Hongqiao Rd., Shanghai 200030, China
Phone: +86-21-6448-4753, Fax: +86-21-6448-3992

IAI CORPORATION

577-1 Obane, Shimizu-Ku, Shizuoka, 424-0103, Japan
Phone: +81-543-64-5105, Fax: +81-543-64-5192

IAI Robot (Thailand) Co., Ltd

825 PhairojKijja Tower 12th Floor, Bangna-Trad RD.,
Bangna, Bangna, Bangkok 10260, Thailand
Phone: +66-2-361-4457, Fax: +66-2-361-4456