

Rotating Nut Linear Actuator **NS**

Long Stroke and High-Speed Movement



**Small/
Medium-Sized
Series
Additions**

Provides a Long Stroke and Speed Nearly as Fast as Linear Servo Actuators

Maximum Speed 2,400 mm/s, Maximum Acceleration 1 G, Maximum Stroke 3,000 mm



1 Moves the slider by rotating the nut, not the ball screw

The actuator is constructed with a fixed ball screw and a slider that moves linearly when its built-in hollow-shaft motor rotates the nut, instead of the nut moving linearly when the ball screw is rotated.

Since the ball screw is not rotated, the effects of dangerous rotation speeds are reduced, making high-speed movement possible even with a long stroke.

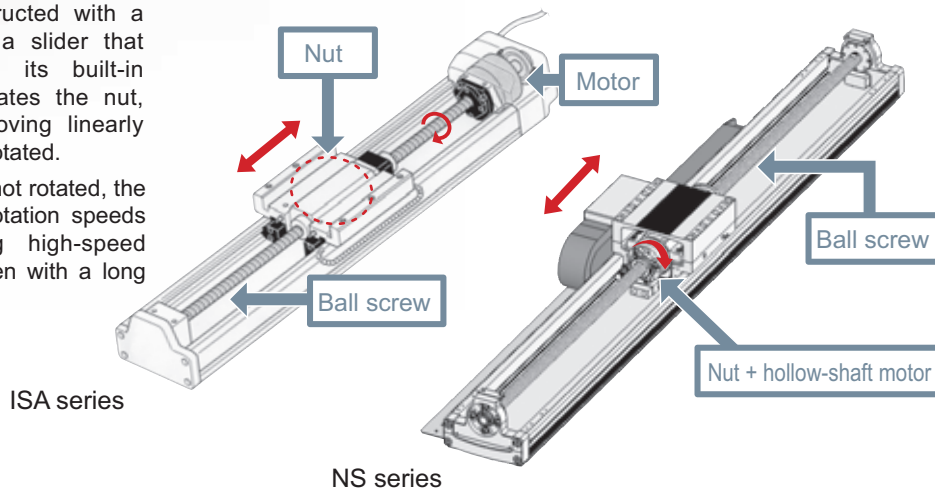

2 High-speed performance with a maximum speed of 2,400 mm/s and maximum acceleration of 1 G

A maximum speed of 2,400 mm/s is attained through the use of a high-lead precision screw (equivalent to C5). In addition, since there is minimal impact from dangerous rotation speeds, movement is possible at the maximum 2,400 mm/s, even at the maximum stroke (3,000 mm), greatly reducing the cycle time.

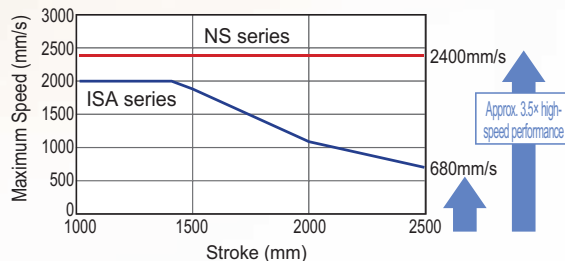

3 Long stroke of 3,000 mm achieved with Mid-Support Mechanisms

By equipping the NS series with mid-support mechanisms which proved well with the ISA series, deflection of the ball screw is suppressed and vibrations are reduced, allowing a stunning 3,000 mm stroke with a ball screw.

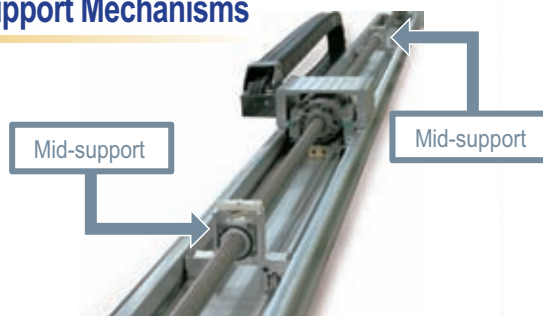

4 Multi-slider compatibility (equipped with collision prevention function)

The multi-slider type, which allows two sliders on a single axis to move independently, saves space and greatly reduces cycle time. In addition, the "collision prevention function", which prevents collisions between sliders, is standard with the XSEL and SSEL controllers.



5 Vertical type (brake as standard equipment)

A brake is installed as standard equipment on the vertical type to prevent the slider from falling if it is vertical when the unit is turned off. This is available with either a single slider or multiple sliders.

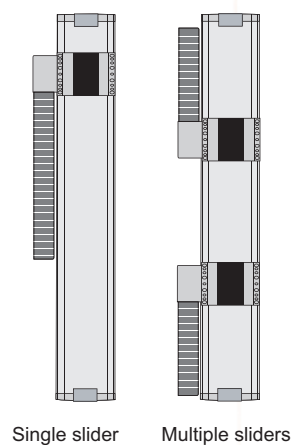

6 AQ seal as standard equipment, providing a long maintenance-free period

The AQ seal is a lubricating unit that contains a lubricant solidified with a resin. Lubricant is supplied to the guide and the ball screw over a long period of time, providing an extended maintenance-free period of 3 years or 5,000 km of operation with periodic applications of grease.

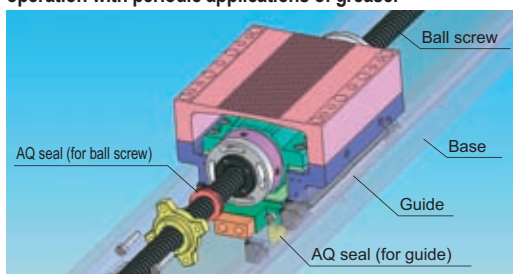





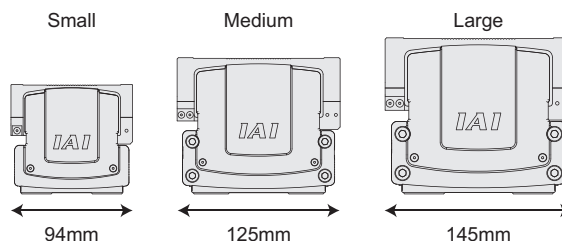

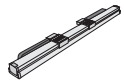

7 Multitude of variations

The extensive product line-up, which allows you to select specifications such as the size, slider type and installation direction, ensures the optimum configuration for any number of applications.

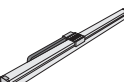

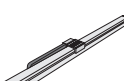
- Sizes: 3 types (small, medium and large)
- Sliders: 2 types (single slider and multiple sliders)
- Installation direction: 2 types (horizontal and vertical)
- Cable track installation direction: 4 directions
- Provided with mid-supports

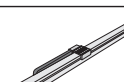
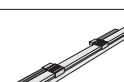
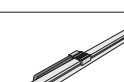
Specification Table

Size	Type	Slider	Appearance	Type	Encoder Type	Motor Type (W)	Lead (mm)	Stroke (mm)	Rated Thrust (N)	Maximum Payload (kg)	Maximum Speed (mm/s)	Reference Pages	
Small	Horizontal	Single Slider		SXMS	Absolute Incremental	60	12	400~800	70.8	15	720	→P7	
		Multi-Slider		SXMM				200~800				→P8	
	Vertical	Single Slider		SZMS				400~800		3	600	→P9	
		Multi-Slider		SZMM				200~800				→P10	
Medium	Horizontal	Single Slider		MXMS		Absolute Incremental	200	30	500~1500	113.9	25	1800	→P11
		Multi-Slider		MXMM				20		170.9	40	1200	
	Horizontal/ With Mid- supports	Single Slider		MXMXS				30	300~1500	113.9	25	1800	→P12
								20		170.9	40	1200	
	Vertical	Single Slider		MZMS	30			1600~2200	113.9	25	1800	→P13	
					20				170.9	40	1200		
	Vertical	Multi-Slider		MZMM	20			500~800	170.9	6	1000	→P14	
					300~800			→P15					
Large	Horizontal	Single Slider		LXMS	Absolute Incremental	400	40	500~2200	170	40	2400	→P16	
		Multi-Slider		LXMM			20		340.1	80	1300		
	Horizontal/ With Mid- supports	Single Slider		LXMXS			40	250~2250	170	40	2400	→P17	
							20		340.1	80	1300		
	Vertical	Single Slider		LZMS			40	2300~3000	170	40	2400	→P18	
							20		340.1	80	1300		
Vertical	Multi-Slider		LZMM	20	500~1000	340.1	16	1000	→P19				
				250~950	→P20								

Model

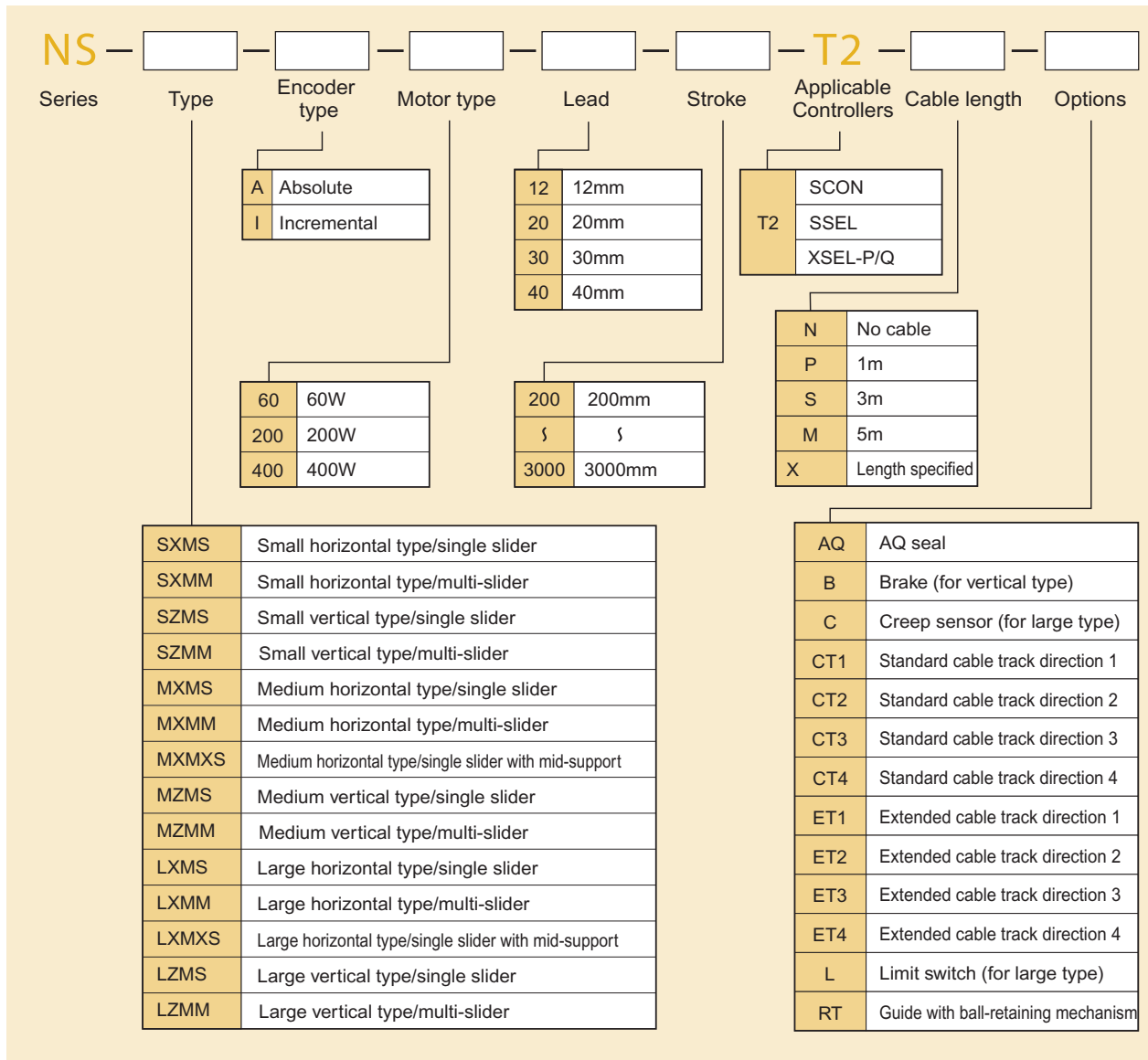

Table of Mass Capacities by Acceleration Condition

1. Horizontal Installation

Type	Mid-Support	Motor Output (W)	Lead (mm)	Maximum Speed (mm/s)	Maximum Acceleration (G)	Load Capacity by Acceleration (kg)								
						0.3G	0.4G	0.5G	0.6G	0.7G	0.8G	0.9G	1.0G	
Small	No	60	12	720	0.8	15	7	5	3	1	0.5	—	—	
Medium	No	200	30	1800	1.0	25	16	10	6	3.5	2	1	0.5	
			20	1200	0.8	40	28	18	10	5	2.5	—	—	
	Yes		30	1800	0.3	25	—	—	—	—	—	—	—	—
			20	1200		40	—	—	—	—	—	—	—	—
Large	No	400	40	2400	1.0	40	30	25	20	17	15	13	10	
			20	1300		80	60	48	40	34	30	27	24	
	Yes		40	2400	0.3	40	—	—	—	—	—	—	—	—
			20	1300		80	—	—	—	—	—	—	—	—

2. Vertical Installation

Type	Mid-Support	Motor Output (W)	Lead (mm)	Maximum Speed (mm/s)	Maximum Acceleration (G)	Load Capacity by Acceleration (kg)							
						0.3G	0.4G	0.5G	0.6G	0.7G	0.8G	0.9G	1.0G
Small	No	60	12	600	0.7	3	2	1.5	1	0.5	—	—	—
Medium	No	200	20	1000	0.5	6	4	3	—	—	—	—	—
Large	No	400	20	1000	0.8	16	12.3	11.1	10.1	9.2	6	—	—

Details of Main Unit Options

AQ Seal (Standard Equipment)

Model **AQ**

Details

The AQ seal is a lubricated unit using lubricated materials in which a lubricant is solidified with a resin.

The lubricant is supplied when the AQ seal contacts the guide and the ball screw thread, making it maintenance-free for a long period with the application of grease. (Standard equipment for all models)

Brake (Standard Equipment for Vertical Type)

Model **B**

Details

This is a holding mechanism to prevent the slider from falling and damaging installed items when the power or the servo is off when the actuator is used at a vertical position. (Standard equipment for the vertical type/No brake for the horizontal type.) *A brake box is attached for the MZMS/MZMM/LZMS/LXMM types. (See P21)

Creep Sensor (Only for Large type) *Not supported for Small/Medium types.

Model **C**

Details

When the homing operation is carried out with the incremental specifications, in order to shorten the homing time, the slider is moved at high speed to just before the position and when it passes this sensor, the speed is dropped to resume normal homing operations. Since this sensor is mounted within the actuator itself, it does not affect the appearance or external dimensions.

Installation Direction of Standard Cable Track/Installation Direction of Expanded Cable Track

Model **CT1/CT2/CT3/CT4 (Installation direction of standard cable track)**
ET1/ET2/ET3/ET4 (Installation direction of extended cable track)

Details

The installation directions for cable tracks can be selected from the four types shown below, including the standard installation direction. (the body base has a reamer hole on the right side and a long hole on the left side).

In addition, if the capacity is insufficient for the standard cable track, an extended cable track with increased capacity can be selected.

Note 1: The cable track can be installed in one direction only for the multi-slider type.

Note 2: For NS-S and NS-M, the extended cable cannot be selected.

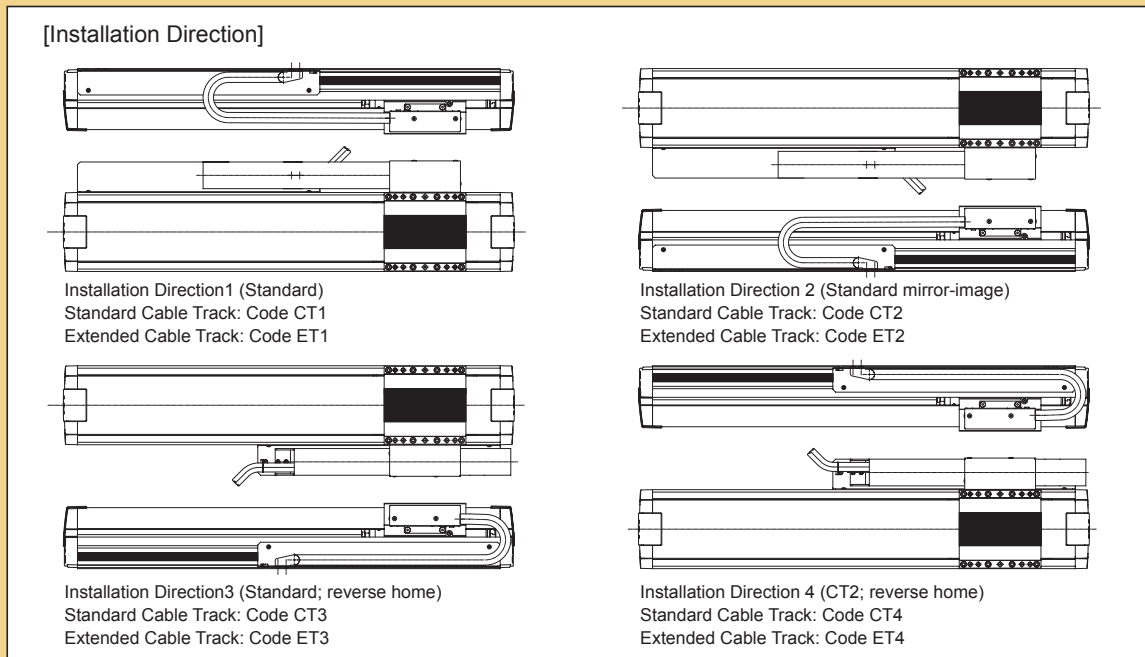

Origin Point Limit Switch (For Large type)

*Not supported for Small/Medium types.

Model **L**

Details

For the normal homing operation in the NS series, the "pressing method" is employed, wherein the slider is pressed against the stopper to detect the Z phase after reversing and to decide the home position.

The L option (Home Limit Switch) for this homing operation detects and reverses using the proximity sensor instead of the pressing method. Since this sensor is mounted within the actuator itself, it does not affect the appearance or external dimensions.

Guide with Ball-retaining Mechanism (Standard Equipment)

Model **RT**

Details

This is a ball-retaining mechanism for eliminating collisions between balls to provide a long maintenance-free period and long life by inserting a spacer (a retaining device) between the guide balls (steel balls) (Standard equipment for all models)

Internal Dimensions of Cable Track

Small

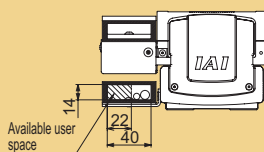

Medium

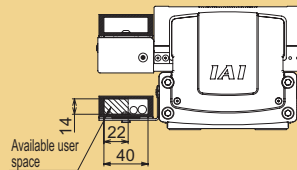

Regarding the outer diameter and the number of cables to be stored

- (1) Make gaps of at least 2 mm between the outer diameter and the inside wall of the cable and between the cables.
- (2) The outer diameter of the cables should be $\phi 12$ or less and they should be arranged and used horizontally so that they do not cross each other.
- (3) Note that the life of the cables may be extremely shortened due to forces applied on the cables if the number of cables stored exceeds the specification.

Large

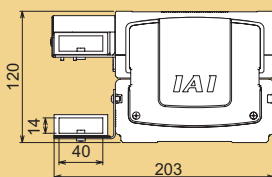

<<Standard Cable Track>>

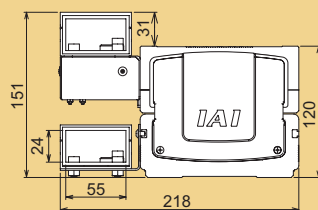

<<Extended Cable Track>>

Regarding the outer diameter and the number of cables to be stored

- (1) Make gaps of at least 2 mm between the outer diameter and the inside wall of the cable and between the cables.
- (2) For the cables, the outer diameter of the standard cable track should be $\phi 12$ or less and that of the extended cable track should be $\phi 16.8$ or less. They should be arranged and used horizontally so that they do not cross each other.
- (3) Note that the life of the cables may be extremely shortened due to forces applied on the cables if the number of cables stored exceeds the specification.

NS-SXMS

Single-Axis Robot Small Nut Rotation Type Main Unit Width 94mm 60W
Horizontal Type Single Slider



■Model **NS — SXMS — [] — 60 — [] — [] — T2 — [] — AQ — [] — RT**

Series	Type	Encoder Type	Motor Type	Lead	Stroke	Applicable Controller	Cable Length	Option
		A: Absolute I: Incremental	60: 60W	12: 12 mm	400: 400mm 800: 800mm	T2: SCON SSEL XSEL-P/Q	N: No S: 3m M: 5m X□: Length Specified	See the options table below

Model/Specification

Model	Encoder Type	Motor Output (W)	Lead (mm)	Stroke (mm)	Speed (mm/s)	Acceleration (Note 1)				Payload Capacity (Note 1 & 2)				Rated Thrust (N)
						Horizontal(G)		Vertical(G)		Horizontal(kg)		Vertical(kg)		
						Rated	Maximum	Rated	Maximum	Rated Acceleration	Maximum Acceleration	Rated Acceleration	Maximum Acceleration	
NS-SXMS-[]-60-12-[]-T2-[]-AQ-[]-RT	Absolute Incremental	60	12	400-800	720	0.3	0.8	Horizontal Only	Horizontal Only	15	0.5	Horizontal Only	70.8	

*In the model above, [] indicates the type of encoder, [] indicates the stroke, [] indicates the cable length, and [] indicates the option.

Option

Name	Model	Reference page	Note
AQ Seal	AQ	→P5	Standard Equipment
Installation Direction of Standard Cable Track	CT1-CT4	→P5	Enter CT1 for standard installation
Guide with Ball-Retaining Mechanism	RT	→P6	Standard Equipment

Common specifications

Driving Method	Ball Thread, Diameter ϕ 10 mm, Equivalent to Rolled C10
Repeated Positioning Accuracy	+/- 0.02mm
Backlash	0.05mm or less
Guide	Integrated to Base
Dynamic Allowable Moment(Note 3)	Ma:28.4N·m Mb:40.2N·m Mc:65.7N·m
Overhung load length	Ma Direction: 450mm or less; Mb and Mc Direction: 450mm or less
Base	Material: Aluminium, White Alumite Treatment
Cable Length (Note 4)	N: No cable; S: 3 m; M: 5 m; X□: Length specified
Ambient Temperature	0~40 degrees Celsius, 85% RH or less (No condensation)

Dimensional drawing

The CAD drawings can be downloaded from our homepage.

2D CAD

*1 Connects motor cables and encoder cables.
For details on cables, please see page 22.

SE: Stroke End
ME: Mechanical End

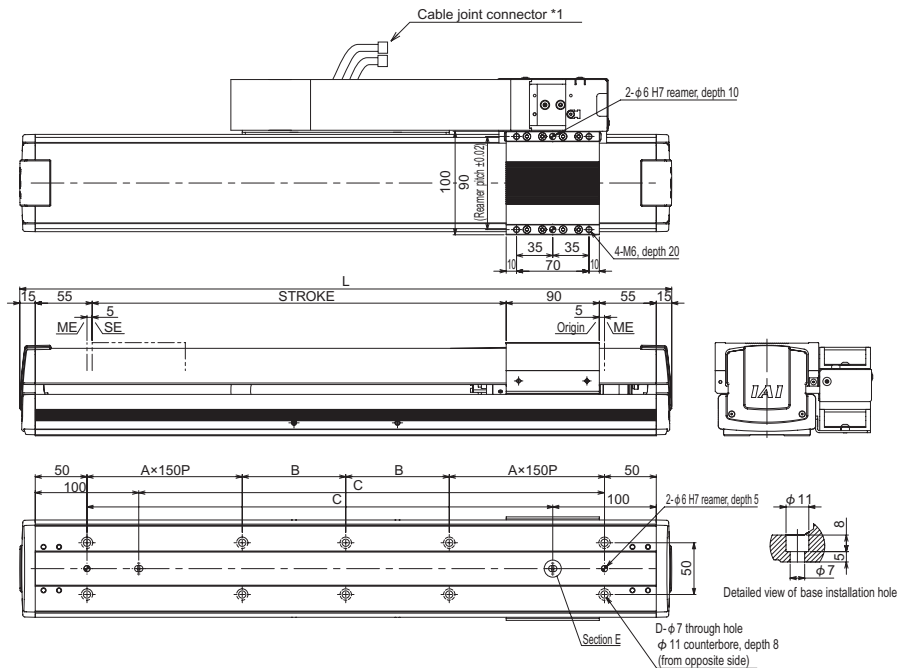
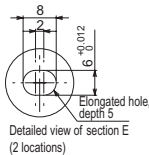
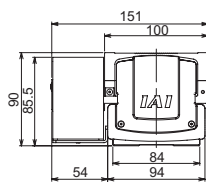

*For the internal dimensions of the cable track, please see page 6.

Stroke	400	500	600	700	800
L	630	730	830	930	1030
A	1	1	1	2	2
B	100	150	200	100	150
C	450	550	650	750	850
D	10	10	10	14	14
Mass(kg)	5.8	6.5	7.1	7.8	8.4

Applicable Controller Specifications

Applicable Controller	Max. Number of Axes Controlled	Compatible Encoder Type	Operation Method	Power/Voltage
X-SEL-P/Q	6 axis	Absolute/ Incremental	Programs Positioner Pulse Train Control	Three-Phase/ Single-Phase 200VAC
SSEL	2 axis			Single-Phase 100/200VAC
SCON	1 axis			



(Note 1) For the relationship between acceleration and payload capacity, see page 4.
(Note 2) The values shown are payload capacities during operation at maximum speed.
(Note 3) For a 10,000-km running life.
(Note 4) The maximum cable length is 30 m. Please specify length in meters.
(E.g., X08 = 8 m)

NS-SXMM

Single-Axis Robot Small Nut Rotation Type Main Unit Width 94mm 60W
Horizontal Type Multi-Slider



Model		NS — SXMM — [] — 60 — [] — [] — T2 — [] — AQ — CT1 — RT										
Series	Type	Encoder Type	Motor Type	Lead	Stroke	Applicable controller	Cable Length	See the options table below				
		A: Absolute I: Incremental	60: 60W	12: 12 mm	200: 200mm 800: 800mm	T2: SCON SSEL XSEL-P/Q	N: No S: 3m M: 5m X□□: Length Specified					

Model/Specification

Model	Encoder Type	Motor Output (W)	Lead (mm)	Stroke (mm)	Speed (mm/s)	Acceleration (Note 1)				Payload Capacity (Note 1 & 2)				Rated Thrust (N)
						Horizontal (G)		Vertical (G)		Horizontal (kg)		Vertical (kg)		
						Rated	Maximum	Rated	Maximum	Rated	Maximum	Rated	Maximum	
NS-SXMM-[]-60-12-[]-T2-[]-AQ-[]-RT	Absolute Incremental	60	12	200-800	720	0.3	0.8	Horizontal Only		15	0.5	Horizontal Only		70.8

*In the model above, [] indicates the type of encoder, [] indicates the stroke, [] indicates the cable length, and [] indicates the option.

Option

Name	Model	Reference page	Note
AQ Seal	AQ	→P5	Standard Equipment
Installation Direction of Standard Cable Track	CT1	→P5	CT1 for standard
Guide with Ball-Retaining Mechanism	RT	→P6	Standard Equipment

Common specifications

Driving Method	Ball Thread, Diameter φ10 mm, Equivalent to Rolled C10
Repeated Positioning Accuracy	+/- 0.02mm
Backlash	0.05mm or less
Guide	Integrated to Base
Dynamic Allowable Moment (Note 3)	Ma:28.4N·m Mb:40.2N·m Mc:65.7N·m
Overhung load length	Ma Direction: 450mm or less; Mb and Mc Direction: 450mm or less
Base	Material: Aluminium, White Alumite Treatment
Cable Length (Note 4)	N: No cable; S: 3 m; M: 5 m; X□□: Length specified
Ambient Temperature	0-40 degrees Celsius, 85% RH or less (No condensation)

Dimensional drawing

The CAD drawings can be downloaded from our homepage.

2D
CAD

*1 Connects motor cables and encoder cables.
For details on cables, please see page 22.

SE: Stroke End
ME: Mechanical End

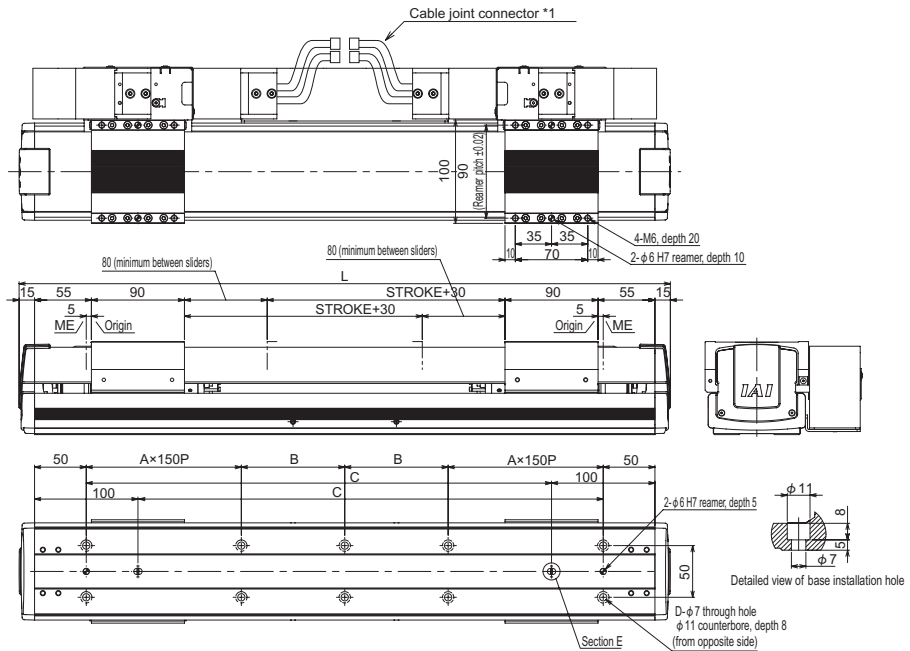
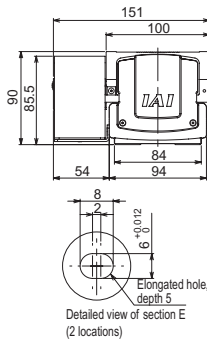

*For the internal dimensions of the cable track, please see page 6.

Stroke	200	300	400	500	600	700	800
L	630	730	830	930	1030	1130	1230
A	1	1	1	2	2	2	2
B	100	150	200	100	150	200	100
C	450	550	650	750	850	950	1050
D	10	10	10	14	14	14	18
Mass (kg)	7.5	8.1	8.7	9.4	10.0	10.7	11.3

Applicable Controller Specifications

Applicable Controller	Max. Number of Axes Controlled	Compatible Encoder Type	Operation Method	Power/Voltage
X-SEL-P/Q	6 axis	Absolute/ Incremental	Programs	Three-Phase/ Single-Phase 200VAC
SSEL	2 axis		Positioner Pulse Train Control	Single-Phase 100/200VAC
SCON	1 axis			

Note: A two-axis controller is required to operate the multi-slider.
Two controllers are required for SCON.
(Please note that SCON does not have a collision prevention mechanism)



Note

(Note 1) For the relationship between acceleration and payload capacity, see page 4.
(Note 2) The values shown are payload capacities during operation at maximum speed.
(Note 3) For a 10,000-km running life.
(Note 4) The maximum cable length is 30 m. Please specify length in meters.
(E.g., X08 = 8 m)

NS-SZMS

Single-Axis Robot Small Nut Rotation Type Main Unit Width 94mm 60W
Vertical Type Single Slider



■Model **NS — SZMS — [] — 60 — [] — [] — T2 — [] — AQ — B — [] — RT**

Series	Type	Encoder Type	Motor Type	Lead	Stroke	Applicable controller	Cable Length
NS	SZMS	A: Absolute I: Incremental	60: 60W	12: 12 mm	400: 400mm 800: 800mm	T2: SCON SSEL XSEL-P/Q	N: No S: 3m M: 5m X□□: Length Specified

See the options table below

Model/Specification

Model	Encoder Type	Motor Output (W)	Lead (mm)	Stroke (mm)	Speed (mm/s)	Acceleration (Note 1)				Payload Capacity (Note 1 & 2)				Rated Thrust (N)
						Horizontal (G)		Vertical (G)		Horizontal (kg)		Vertical (kg)		
						Rated	Maximum	Rated	Maximum	Rated	Maximum	Rated	Maximum	
NS-SZMS-[]-60-12-[]-T2-[]-AQ-[]-RT	Absolute Incremental	60	12	400-800	600	Vertical Only		0.3	0.7	Vertical Only	3	0.5	70.8	

*In the model above, [] indicates the type of encoder, [] indicates the stroke, [] indicates the cable length, and [] indicates the option.

Option

Name	Model	Reference page	Note
AQ Seal	AQ	→P5	Standard Equipment
Brake	B	→P5	Standard Equipment
Installation Direction of Standard Cable Track	CT1~CT4	→P5	Enter CT1 for standard installation
Guide with Ball-Retaining Mechanism	RT	→P6	Standard Equipment

Common specifications

Driving Method	Ball Thread, Diameter ϕ 10 mm, Equivalent to Rolled C10
Repeated Positioning Accuracy	+/- 0.02mm
Backlash	0.05mm or less
Guide	Integrated to Base
Dynamic Allowable Moment (Note 3)	Ma: 28.4 N·m, Mb: 40.2 N·m, Mc: 33.3N·m
Overhung load length	Ma Direction: 450mm or less; Mb and Mc Direction: 450mm or less
Base	Material: Aluminium, White Alumite Treatment
Cable Length (Note 4)	N: No cable; S: 3 m; M: 5 m; X□□: Length specified
Ambient Temperature	0~40 degrees Celsius, 85% RH or less (No condensation)

Dimensional drawing

The CAD drawings can be downloaded from our homepage.

2D CAD

*1 Connects motor cables and encoder cables.
For details on cables, please see page 22.

SE: Stroke End
ME: Mechanical End

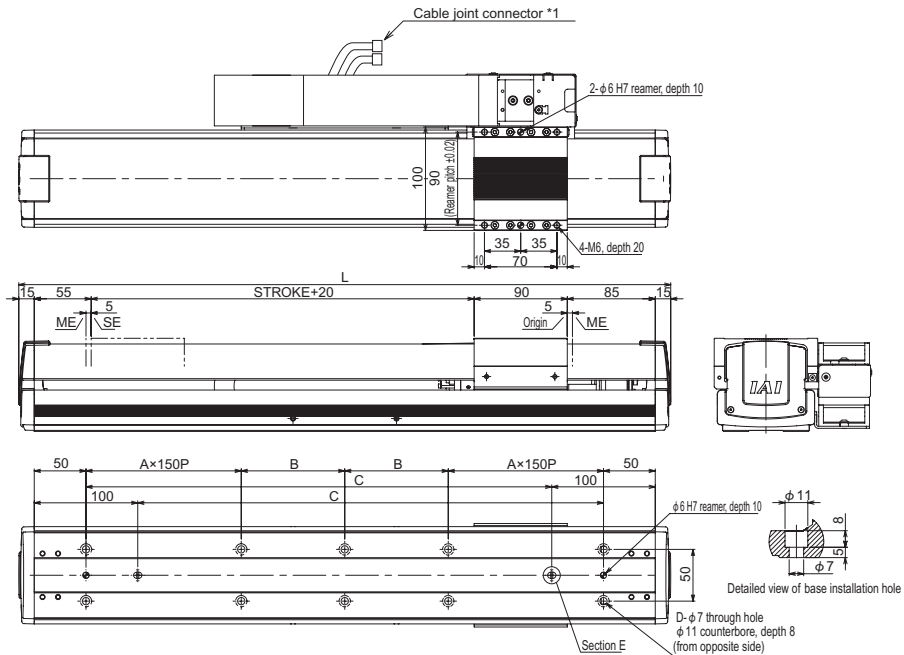
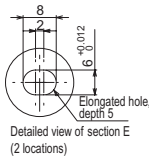
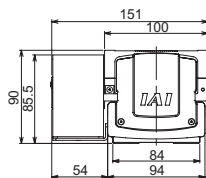

*For the internal dimensions of the cable track, please see page 6.

Stroke	400	500	600	700	800
L	680	780	880	980	1080
A	1	1	1	2	2
B	125	175	225	125	175
C	500	600	700	800	900
D	10	10	10	14	14
Mass (kg)	6.2	6.8	7.4	8.1	8.7

Applicable Controller Specifications

Applicable Controller	Max. Number of Axes Controlled	Compatible Encoder Type	Operation Method	Power/Voltage
X-SEL-P/Q	6 axis	Absolute/Incremental	Programs Positioner Pulse Train Control	Three-Phase/ Single-Phase 200VAC
SSEL	2 axis			Single-Phase 100/200VAC
SCON	1 axis			



Note

(Note 1) For the relationship between acceleration and payload capacity, see page 4.
(Note 2) The values shown are payload capacities during operation at maximum speed.
(Note 3) For a 10,000-km running life.
(Note 4) The maximum cable length is 30 m. Please specify length in meters.
(E.g., X08 = 8 m)

NS-SZMM

Single-Axis Robot Small Nut Rotation Type Main Unit Width 94mm 60W
Vertical Type Multi-Slider



■ Model **NS — SZMM — [] — 60 — [] — [] — T2 — [] — AQ — B — CT1 — RT**

Series	Type	Encoder Type	Motor Type	Lead	Stroke	Applicable controller	Cable Length	
NS	SZMM	A: Absolute I: Incremental	60: 60W	12: 12 mm	200: 200mm 800: 800mm	T2: SCON SSEL XSEL-P/Q	N: No S: 3m M: 5m X: Length Specified	See the options table below

Model/Specification

Model	Encoder Type	Motor Output (W)	Lead (mm)	Stroke (mm)	Speed (mm/s)	Acceleration (Note 1)				Payload Capacity (Note 1 & 2)				Rated Thrust (N)
						Horizontal (G)		Vertical (G)		Horizontal (kg)		Vertical (kg)		
						Rated	Maximum	Rated	Maximum	Rated	Maximum	Rated	Maximum	
NS-SZMM-[]-60-12-[]-T2-[]-AQ-[]-RT	Absolute Incremental	60	12	200-800	600	Vertical Only		0.3	0.7	Vertical Only	3	0.5	70.8	

*In the model above, [] indicates the type of encoder, [] indicates the stroke, [] indicates the cable length, and [] indicates the option.

Option

Name	Model	Reference page	Note
AQ Seal	AQ	→P5	Standard Equipment
Brake	B	→P5	Standard Equipment
Installation Direction of Standard Cable Track	CT1	→P5	CT1 for standard
Guide with Ball-Retaining Mechanism	RT	→P6	Standard Equipment

Common specifications

Driving Method	Ball Thread, Diameter φ10 mm, Equivalent to Rolled C10
Repeated Positioning Accuracy	+/- 0.02mm
Backlash	0.05mm or less
Guide	Integrated to Base
Dynamic Allowable Moment (Note 3)	Ma: 28.4 N·m, Mb: 40.2 N·m, Mc: 33.3N·m
Overhung load length	Ma Direction: 450mm or less; Mb and Mc Direction: 450mm or less
Base	Material: Aluminium, White Alumite Treatment
Cable Length (Note 4)	N: No cable; S: 3 m; M: 5 m; X: Length specified
Ambient Temperature	0-40 degrees Celsius, 85% RH or less (No condensation)

Dimensional drawing

The CAD drawings can be downloaded from our homepage.

2D CAD

*1 Connects motor cables and encoder cables.
For details on cables, please see page 22.

SE: Stroke End
ME: Mechanical End

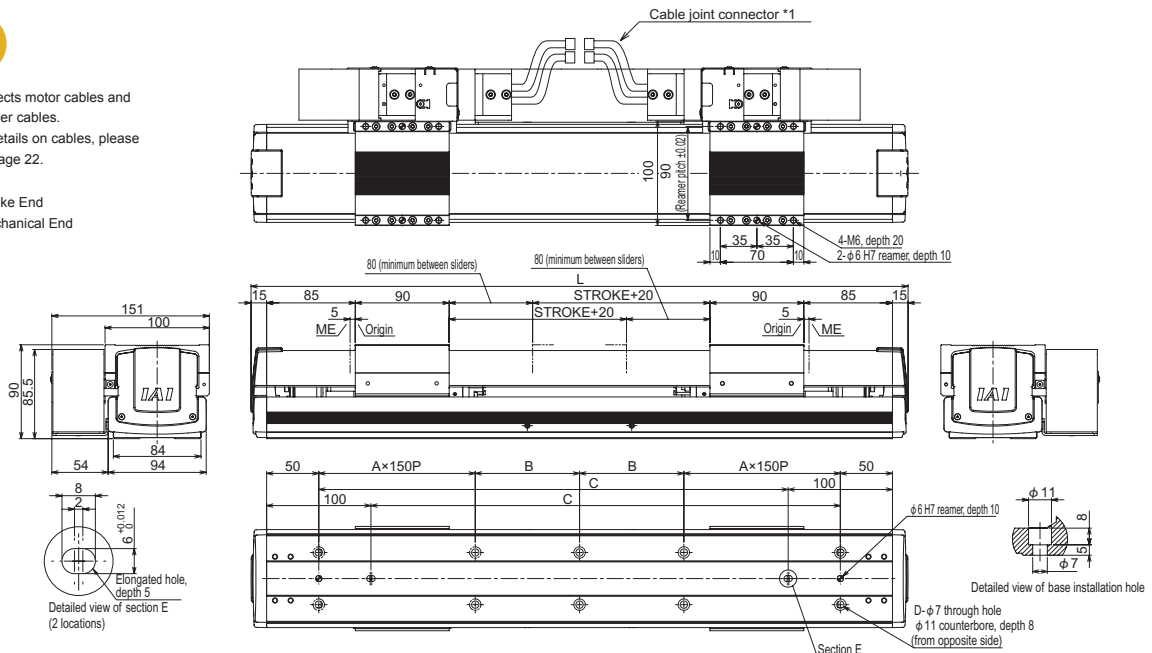

*For the internal dimensions of the cable track, please see page 6.

Stroke	200	300	400	500	600	700	800
L	680	780	880	980	1080	1180	1280
A	1	1	1	2	2	2	3
B	125	175	225	125	175	225	125
C	500	600	700	800	900	1000	1100
D	10	10	10	14	14	14	18
Mass (kg)	7.7	8.4	9.0	9.7	10.3	10.9	11.6

Applicable Controller Specifications

Applicable Controller	Max. Number of Axes Controlled	Compatible Encoder Type	Operation Method	Power/Voltage
X-SEL-P/Q	6 axis	Absolute/ Incremental	Programs	Three-Phase/ Single-Phase 200VAC
SSEL	2 axis		Positioner Pulse Train Control	Single-Phase 100/200VAC
SCON	1 axis			

Note: A two-axis controller is required to operate the multi-slider.
Two controllers are required for SCON.
(Please note that SCON does not have a collision prevention mechanism)



Note

(Note 1) For the relationship between acceleration and payload capacity, see page 4.
 (Note 2) The values shown are payload capacities during operation at maximum speed.
 (Note 3) For a 10,000-km running life.
 (Note 4) The maximum cable length is 30 m. Please specify length in meters.
 (E.g., X08 = 8 m)

NS-MXMS

Single-Axis Robot Medium Nut Rotation Type Main Unit Width 125mm 200W
Horizontal Type Single Slider



■Model **NS — MXMS — [] — 200 — [] — [] — T2 — [] — AQ — [] — RT**

Series	Type	Encoder Type	Motor Type	Lead	Stroke	Applicable controller	Cable Length	Option
		A: Absolute I: Incremental	200: 200W	30: 30mm 20: 20 mm	500: 500mm 1500: 1,500mm	T2: SCON SSEL XSEL-P/Q	N: No S: 3m M: 5m X□□: Length Specified	See the options table below

Model/Specification

Model	Encoder Type	Motor Output (W)	Lead (mm)	Stroke (mm)	Speed (mm/s)	Acceleration (Note 1)				Payload capacity (Note 1 & 2)				Rated Thrust (N)
						Horizontal (G)		Vertical (G)		Horizontal (kg)		Vertical (kg)		
						Rated	Maximum	Rated	Maximum	Rated Acceleration	Maximum Acceleration	Rated Acceleration	Maximum Acceleration	
NS-MXMS-[]-200-30-[]-T2-[]-AQ-[]-RT	Absolute	200	30	500~1500	1800	0.3	1.0	Horizontal Only		25	0.5	Horizontal Only		113.9
NS-MXMS-[]-200-20-[]-T2-[]-AQ-[]-RT	Incremental		20		1200	0.3	0.8			40	2.5			170.9

*In the model above, [] indicates the type of encoder, [] indicates the stroke, [] indicates the cable length, and [] indicates the option.

Option

Name	Model	Reference page	Note
AQ Seal	AQ	→P5	Standard Equipment
Installation Direction of Standard Cable Track	CT1~CT4	→P5	Enter CT1 for standard installation
Guide with Ball-Retaining Mechanism	RT	→P6	Standard Equipment

Common specifications

Driving Method	Ball Thread, Diameter φ16 mm, Equivalent to Rolled C5
Repeated Positioning Accuracy	+/- 0.01 mm
Backlash	0.02 mm or less
Guide	Integrated to Base
Dynamic Allowable Moment (Note 3)	Ma: 69.6N·m, Mb: 99.0N·m, Mc: 161.7N·m
Overhung load length	Ma Direction: 600mm or less; Mb and Mc Direction: 600mm or less
Base	Material: Aluminium, White Alumite Treatment
Cable Length (Note 4)	N: No cable; S: 3 m; M: 5 m; X□□: Length specified
Ambient Temperature	0~40 degrees Celsius, 85% RH or less (No condensation)

Dimensional drawing

The CAD drawings can be downloaded from our homepage.

2D CAD

*1 Connects motor cables and encoder cables.
For details on cables, please see page 22.

SE: Stroke End
ME: Mechanical End

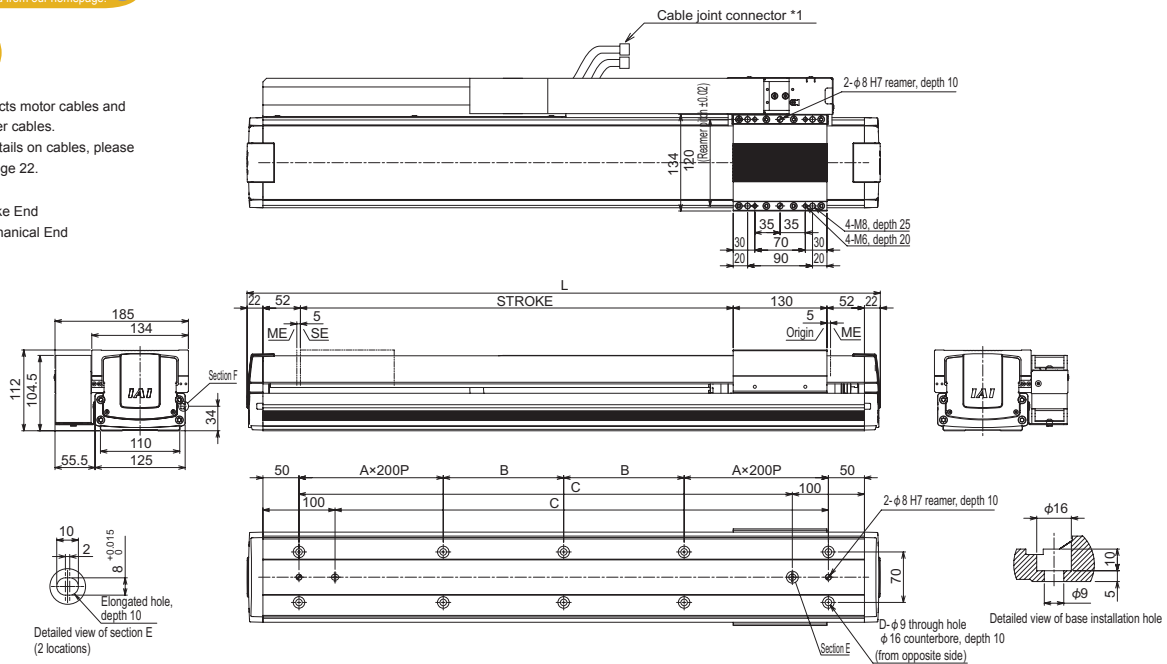

*For the internal dimensions of the cable track, please see page 6.

Stroke	500	600	700	800	900	1000	1100	1200	1300	1400	1500
L	778	878	978	1078	1178	1278	1378	1478	1578	1678	1778
A	0	1	1	1	1	2	2	2	2	3	3
B	317	167	217	267	317	167	217	267	317	167	217
C	584	684	784	884	984	1084	1184	1284	1384	1484	1584
D	6	10	10	10	10	14	14	14	14	18	18
Mass (kg)	11.9	13.1	14.4	15.6	16.8	18.0	19.3	20.5	21.7	23.0	24.2

Applicable Controller Specifications

Applicable Controller	Max. Number of Axes Controlled	Compatible Encoder Type	Operation Method	Power/Voltage
X-SEL-P/Q	6 axis	Absolute/ Incremental	Programs Positioner Pulse Train Control	Three-Phase/ Single-Phase 200V AC
SSEL	2 axis			Single-Phase 100/200VAC
SCON	1 axis			



Note

(Note 1) For the relationship between acceleration and payload capacity, see page 4.
 (Note 2) The values shown are payload capacities during operation at maximum speed.
 (Note 3) For a 10,000-km running life.
 (Note 4) The maximum cable length is 30 m. Please specify length in meters.
 (E.g., X08 = 8 m)
 (Note 5) When an axis with a long stroke (1,300 mm or more) is used hanging from the ceiling, the cover of the body may hang down and contact the slider. Therefore, in cases of such use, please contact our sales representative in advance.

NS-MXMM

Single-Axis Robot Medium Nut Rotation Type Main Unit Width 125mm 200W
Horizontal Type Multi-Slider

■Model **NS — MXMM — [] — 200 — [] — [] — T2 — [] — AQ — CT1 — RT**

Series	Type	Encoder Type	Motor Type	Lead	Stroke	Applicable controller	Cable Length	Option
		A: Absolute I: Incremental	200: 200W	30: 30mm 20: 20 mm	300: 300mm 1500: 1,500mm	T2: SCON SSEL XSEL-P/Q	N: No S: 3m M: 5m X□□: Length Specified	See the options table below



Model/Specification

Model	Encoder Type	Motor Output (W)	Lead (mm)	Stroke (mm)	Speed (mm/s)	Acceleration (Note 1)				Payload capacity (Note 1 & 2)				Rated Thrust (N)
						Horizontal (G)		Vertical (G)		Horizontal (kg)		Vertical (kg)		
						Rated	Maximum	Rated	Maximum	Rated	Maximum	Rated	Maximum	
NS-MXMM-[]-200-30-[]-T2-[]-AQ-[]-RT	Absolute	200	30	300~1500	1800	0.3	1.0	Horizontal Only		25	0.5	Horizontal Only		113.9
NS-MXMM-[]-200-20-[]-T2-[]-AQ-[]-RT	Incremental		20		1200	0.3	0.8			40	2.5			170.9

*In the model above, [] indicates the type of encoder, [] indicates the stroke, [] indicates the cable length, and [] indicates the option.

Option

Name	Model	Reference page	Note
AQ Seal	AQ	→P5	Standard Equipment
Installation Direction of Standard Cable Track	CT1	→P5	CT1 for standard
Guide with Ball-Retaining Mechanism	RT	→P6	Standard Equipment

Common specifications

Driving Method	Ball Thread, Diameter φ16 mm, Equivalent to Rolled C5
Repeated Positioning Accuracy	+/- 0.01 mm
Backlash	0.02 mm or less
Guide	Integrated to Base
Dynamic Allowable Moment (Note 3)	Ma: 69.6N·m, Mb: 99.0N·m, Mc: 161.7N·m
Overhung load length	Ma Direction: 600mm or less; Mb and Mc Direction: 600mm or less
Base	Material: Aluminium, White Alumite Treatment
Cable Length (Note 4)	N: No cable; S: 3 m; M: 5 m; X□□: Length specified
Ambient Temperature	0~40 degrees Celsius, 85% RH or less (No condensation)

Dimensional drawing

The CAD drawings can be downloaded from our homepage.

2D CAD

*1 Connects motor cables and encoder cables.
For details on cables, please see page 22.

SE: Stroke End
ME: Mechanical End

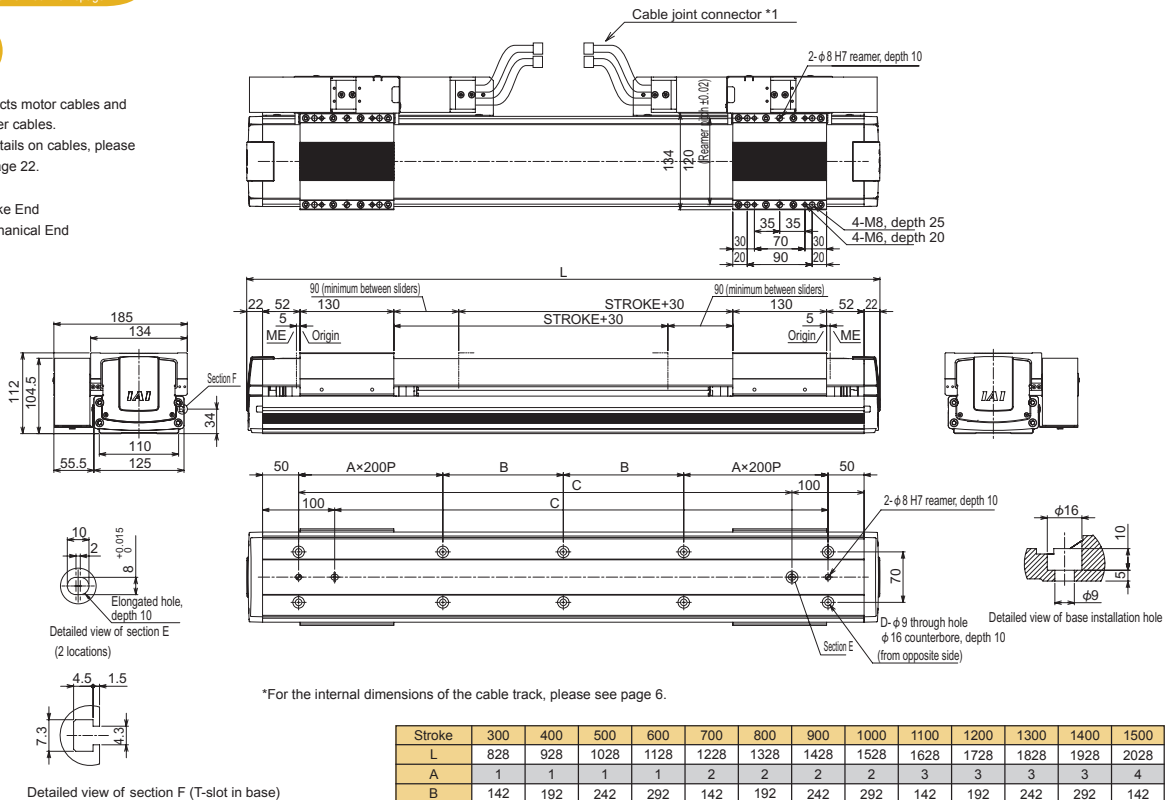

*For the internal dimensions of the cable track, please see page 6.

Stroke	300	400	500	600	700	800	900	1000	1100	1200	1300	1400	1500
L	828	928	1028	1128	1228	1328	1428	1528	1628	1728	1828	1928	2028
A	1	1	1	1	2	2	2	2	3	3	3	3	4
B	142	192	242	292	142	192	242	292	142	192	242	292	142
C	634	734	834	934	1034	1134	1234	1334	1434	1534	1634	1734	1834
D	10	10	10	10	14	14	14	14	18	18	18	18	22
Mass (kg)	15.6	16.8	18	19.2	20.5	21.7	22.9	24.2	25.4	26.6	27.9	29.1	30.3

Applicable Controller Specifications

Applicable Controller	Max. Number of Axes Controlled	Compatible Encoder Type	Operation Method	Power/Voltage
X-SEL-P/Q	6 axis	Absolute/ Incremental	Programs Positioner Pulse Train Control	Three-Phase/ Single-Phase 200VAC
SSEL	2 axis			Single-Phase 100/200VAC
SCON	1 axis			

Note: A two-axis controller is required to operate the multi-slider.
Two controllers are required for SCON.
(Please note that SCON does not have a collision prevention mechanism)



Note

(Note 1) For the relationship between acceleration and payload capacity, see page 4.
(Note 2) The values shown are payload capacities during operation at maximum speed.
(Note 3) For a 10,000-km running life.
(Note 4) The maximum cable length is 30 m. Please specify length in meters.
(E.g., X08 = 8 m)
(Note 5) When an axis with a long stroke (1,300 mm or more) is used hanging from the ceiling, the cover of the body may hang down and contact the slider. Therefore, in cases of such use, please contact our sales representative in advance.

NS-MXMXS

Single-Axis Robot Medium Nut Rotation Type Main Unit Width 125mm 200W
Horizontal Type With Mid-Support Single Slider



■Model **NS — MXMXS — [] — 200 — [] — [] — T2 — [] — AQ — [] — RT**

Series	Type	Encoder Type	Motor Type	Lead	Stroke	Applicable controller	Cable Length	Option
A: Absolute I: Incremental	200: 200W	30: 30mm 20: 20 mm	1600: 1,600mm 2200: 2,200mm	T2: SCON SSEL XSEL-P/Q	N: No S: 3m M: 5m X□□: Length Specified		See the options table below	

Model/Specification

Model	Encoder Type	Motor Output (W)	Lead (mm)	Stroke (mm)	Speed (mm/s)	Acceleration (Note 1)				Payload capacity (Note 1 & 2)		Rated Thrust (N)		
						Horizontal (G)		Vertical (G)		Horizontal (kg)			Vertical (kg)	
						Rated	Maximum	Rated	Maximum	Rated Acceleration	Maximum Acceleration		Rated Acceleration	Maximum Acceleration
NS-MXMXS-[]-200-30-[]-T2-[]-AQ-[]-RT	Absolute	200	30	1600~2200	1800	0.3	Horizontal Only		25	Horizontal Only		113.9		
	Incremental		20		1200	0.3			40			170.9		

*In the model above, [] indicates the type of encoder, [] indicates the stroke, [] indicates the cable length, and [] indicates the option.

Option

Name	Model	Reference page	Note
AQ Seal	AQ	→P5	Standard Equipment
Installation Direction of Standard Cable Track	CT1~CT4	→P5	Enter CT1 for standard installation
Guide with Ball-Retaining Mechanism	RT	→P6	Standard Equipment

Common specifications

Driving Method	Ball Thread, Diameter φ16 mm, Equivalent to Rolled C5
Repeated Positioning Accuracy	+/- 0.01 mm
Backlash	0.02 mm or less
Guide	Integrated to Base
Dynamic Allowable Moment (Note 3)	Ma: 69.6N·m, Mb: 99.0N·m, Mc: 161.7N·m
Overhung load length	Ma Direction: 600mm or less; Mb and Mc Direction: 600mm or less
Base	Material: Aluminium, White Alumite Treatment
Cable Length (Note 4)	N: No cable; S: 3 m; M: 5 m; X□□: Length specified
Ambient Temperature	0~40 degrees Celsius, 85% RH or less (No condensation)

Dimensional drawing

The CAD drawings can be downloaded from our homepage.

2D CAD

*1 Connects motor cables and encoder cables.
For details on cables, please see page 22.

SE: Stroke End
ME: Mechanical End

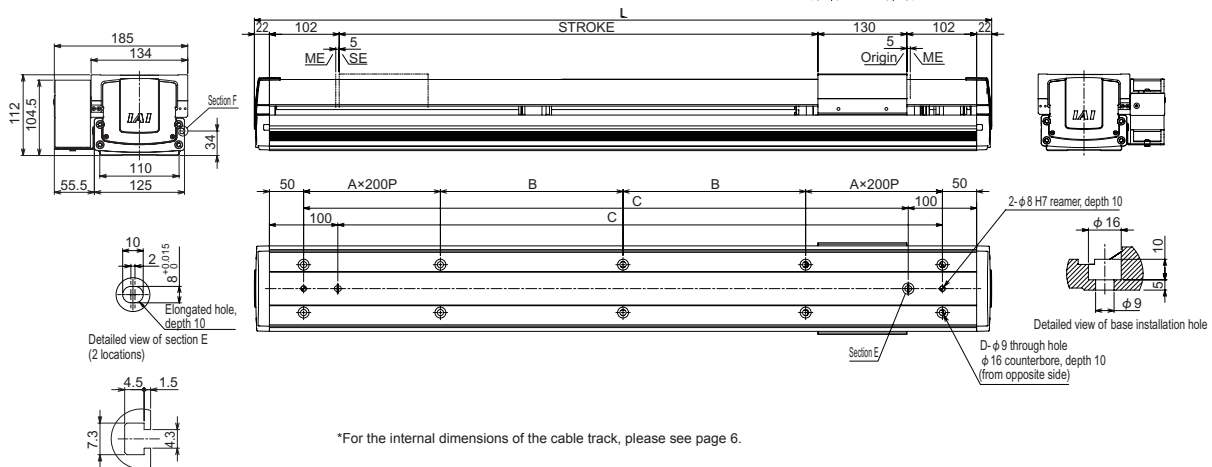

*For the internal dimensions of the cable track, please see page 6.

Detailed view of section F (T-slot in base)

Note: Due to their structure, models with a mid-support cannot be positioned horizontally on their side or vertically.

Stroke	1600	1700	1800	1900	2000	2100	2200
L	1978	2078	2178	2278	2378	2478	2578
A	3	4	4	4	4	5	5
B	317	167	217	267	317	167	217
C	1784	1884	1984	2084	2184	2284	2384
D	18	22	22	22	22	26	26
Mass (kg)	26.2	27.5	28.7	29.9	31.2	32.4	33.6

Applicable Controller Specifications

Applicable Controller	Max. Number of Axes Controlled	Compatible Encoder Type	Operation Method	Power/Voltage
X-SEL-P/Q	6 axis	Absolute/ Incremental	Programs Positioner Pulse Train Control	Three-Phase/ Single-Phase 200VAC
SSEL	2 axis			Single-Phase
SCON	1 axis			100/200VAC



Note

(Note 1) The maximum acceleration is 0.3 G.
 (Note 2) The values shown are payload capacities during operation at maximum speed.
 (Note 3) For a 10,000-km running life.
 (Note 4) The maximum cable length is 30 m. Please specify length in meters.
 (E.g., X08 = 8 m)
 (Note 5) When an axis with a long stroke (1,300 mm or more) is used hanging from the ceiling, the cover of the body may hang down and contact the slider. Therefore, in cases of such use, please contact our sales representative in advance.

NS-MZMS

Single-Axis Robot Medium Nut Rotation Type Main Unit Width 125mm 200W
Vertical Type Single Slider



■ Model **NS — MZMS — [] — 200 — [] — [] — T2 — [] — AQ — B [] — RT**

Series	Type	Encoder Type	Motor Type	Lead	Stroke	Applicable controller	Cable Length
A: Absolute I: Incremental	200: 200W 20: 20 mm	20: 20 mm	20: 20 mm	500: 500mm 800: 800mm	T2: SCON SSEL XSEL-P/Q	N: No S: 3m M: 5m X: Length Specified	See the options table below

Model/Specification

Model	Encoder Type	Motor Output (W)	Lead (mm)	Stroke (mm)	Speed (mm/s)	Acceleration (Note 1)				Payload capacity (Note 1 & 2)				Rated Thrust (N)
						Horizontal (G)		Vertical (G)		Horizontal (kg)		Vertical (kg)		
						Rated	Maximum	Rated	Maximum	Rated	Maximum	Rated	Maximum	
NS-MZMS-[]-200-20-[]-T2-[]-AQ-[]-RT	Absolute Incremental	200	20	500-800	1000	Vertical Only		0.3	0.5	Vertical Only	6	3	170.9	

*In the model above, [] indicates the type of encoder, [] indicates the stroke, [] indicates the cable length, and [] indicates the option.

Option

Name	Model	Reference page	Note
AQ Seal	AQ	→P5	Standard Equipment
Brake (*)	B	→P5	Standard Equipment
Installation Direction of Standard Cable Track	CT1~CT4	→P5	Enter CT1 for standard installation
Guide with Ball-Retaining Mechanism	RT	→P6	Standard Equipment

(*) A brake box is attached for powering the brake.
(For details, see page 21)

Common specifications

Driving Method	Ball Thread, Diameter φ16 mm, Equivalent to Rolled C5
Repeated Positioning Accuracy	+/- 0.01 mm
Backlash	0.02 mm or less
Guide	Integrated to Base
Dynamic Allowable Moment (Note 3)	Ma: 69.6N·m, Mb: 99.0N·m, Mc: 81.3N·m
Overhung load length	Ma Direction: 600mm or less; Mb and Mc Direction: 600mm or less
Base	Material: Aluminium, White Alumite Treatment
Cable Length (Note 4)	N: No cable; S: 3 m; M: 5 m; X: Length specified
Ambient Temperature	0~40 degrees Celsius, 85% RH or less (No condensation)

Dimensional drawing

The CAD drawings can be downloaded from our homepage.

2D CAD

*1 Connects motor cables and encoder cables.
For details on cables, please see page 22.

SE: Stroke End
ME: Mechanical End

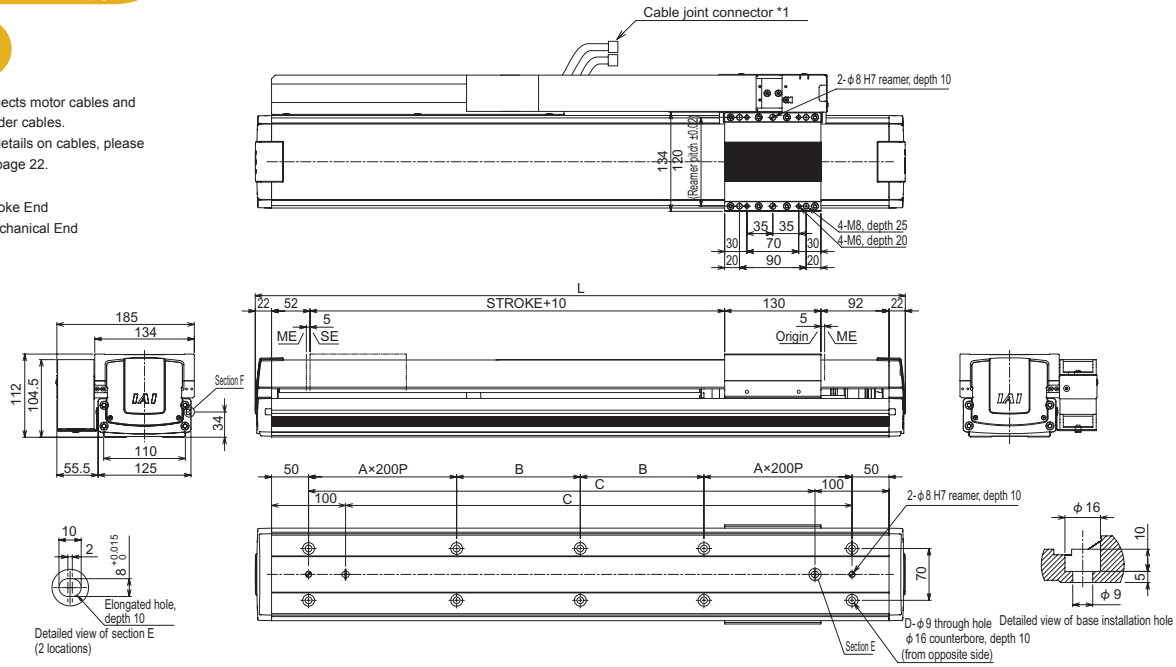

*For the internal dimensions of the cable track, please see page 6.

Stroke	500	600	700	800
L	828	928	1028	1128
A	1	1	1	1
B	142	192	242	292
C	634	734	834	934
D	10	10	10	10
Mass (kg)	13.5	14.8	16.0	17.2

Applicable Controller Specifications

Applicable Controller	Max. Number of Axes Controlled	Compatible Encoder Type	Operation Method	Power/Voltage
X-SEL-P/Q	6 axis	Absolute/ Incremental	Programs Positioner Pulse Train Control	Three-Phase/ Single-Phase 200VAC
SSEL	2 axis			Single-Phase 100/200VAC
SCON	1 axis			

Note

(Note 1) For the relationship between acceleration and payload capacity, see page 4.
 (Note 2) The values shown are payload capacities during operation at maximum speed.
 (Note 3) For a 10,000-km running life.
 (Note 4) The maximum cable length is 30 m. Please specify length in meters.
 (E.g., X08 = 8 m)

NS-MZMM

Single-Axis Robot Medium Nut Rotation Type Main Unit Width 125mm 200W
Vertical Type Multi-Slider

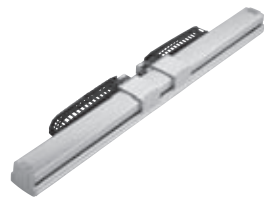

■ Model **NS — MZMM — [] — 200 — [] — [] — T2 — [] — AQ — B — CT1 — RT**

Series	Type	Encoder Type	Motor Type	Lead	Stroke	Applicable controller	Cable Length
NS	MZMM	A: Absolute I: Incremental	200: 200W	20: 20 mm	300: 300mm T2: SCON SSEL 800: 800mm	N: No S: 3m M: 5m XSEL-P/Q X□□: Length Specified	See the options table below

Model/Specification

Model	Encoder Type	Motor Output (W)	Lead (mm)	Stroke (mm)	Speed (mm/s)	Acceleration (Note 1)				Payload capacity (Note 1 & 2)				Rated Thrust (N)
						Horizontal (G)		Vertical (G)		Horizontal (kg)		Vertical (kg)		
						Rated	Maximum	Rated	Maximum	Rated	Maximum	Rated	Maximum	
NS-MZMM-[]-200-20-[]-T2-[]-AQ-[]-RT	Absolute Incremental	200	20	300-800	1000	Vertical Only		0.3	0.5	Vertical Only		6	3	170.9

*In the model above, [] indicates the type of encoder, [] indicates the stroke, [] indicates the cable length, and [] indicates the option.

Option

Name	Model	Reference page	Note
AQ Seal	AQ	→P5	Standard Equipment
Brake (*)	B	→P5	Standard Equipment
Installation Direction of Standard Cable Track	CT1	→P5	CT1 for standard
Guide with Ball-Retaining Mechanism	RT	→P6	Standard Equipment

(*) A brake box is attached for powering the brake.
(For details, see page 21)

Common specifications

Driving Method	Ball Thread, Diameter ϕ 16 mm, Equivalent to Rolled C5
Repeated Positioning Accuracy	+/- 0.01 mm
Backlash	0.02 mm or less
Guide	Integrated to Base
Dynamic Allowable Moment (Note 3)	Ma: 69.6N·m, Mb: 99.0N·m, Mc: 81.3N·m
Overhung load length	Ma Direction: 600mm or less; Mb and Mc Direction: 600mm or less
Base	Material: Aluminium, White Alumite Treatment
Cable Length (Note 4)	N: No cable; S: 3 m; M: 5 m; X□□: Length specified
Ambient Temperature	0~40 degrees Celsius, 85% RH or less (No condensation)

Dimensional drawing

The CAD drawings can be downloaded from our homepage.

2D CAD

*1 Connects motor cables and encoder cables.
For details on cables, please see page 22.

SE: Stroke End
ME: Mechanical End

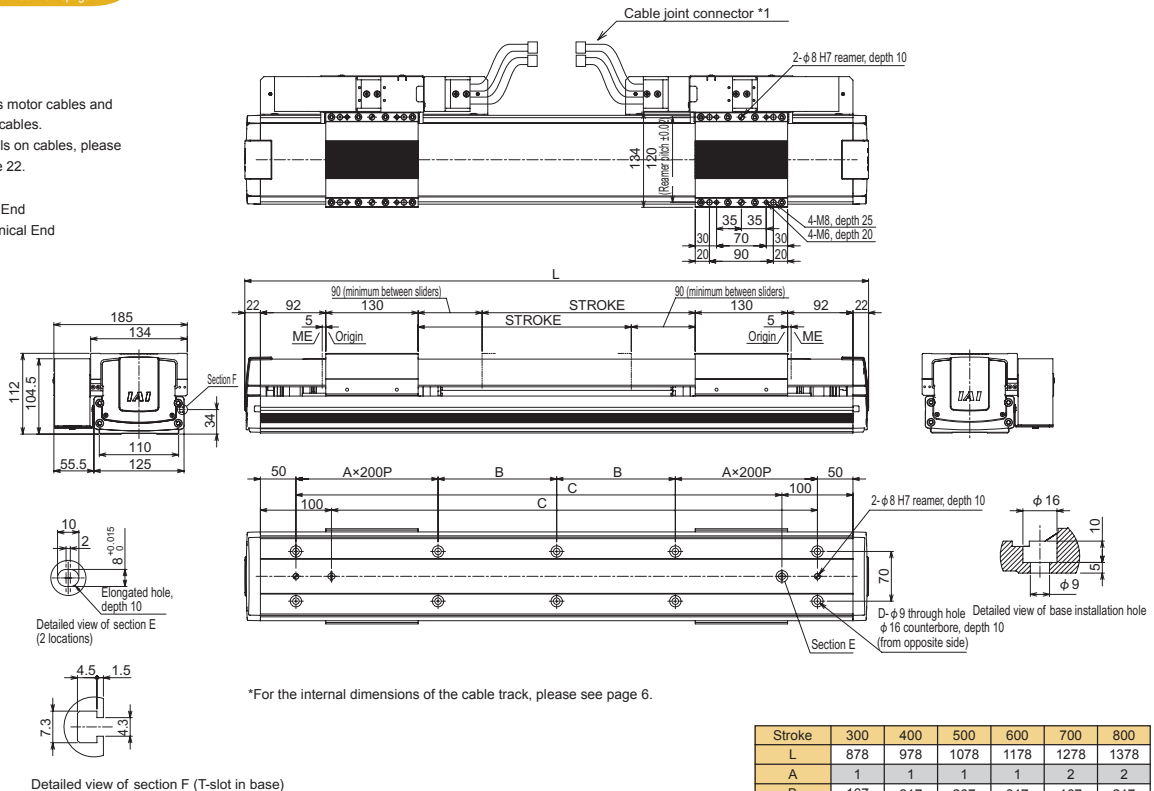

Stroke	300	400	500	600	700	800
L	878	978	1078	1178	1278	1378
A	1	1	1	1	2	2
B	167	217	267	317	167	217
C	684	784	884	984	1084	1184
D	10	10	10	10	14	14
Mass (kg)	17.2	18.4	19.7	20.9	22.1	23.4

Applicable Controller Specifications

Applicable Controller	Max. Number of Axes Controlled	Compatible Encoder Type	Operation Method	Power/Voltage
X-SEL-P/Q	6 axis	Absolute/ Incremental	Programs Positioner Pulse Train Control	Three-Phase/ Single-Phase 200VAC
SSEL	2 axis			Single-Phase 100/200VAC
SCON	1 axis			

Note: A two-axis controller is required to operate the multi-slider.
Two controllers are required for SCON.
(Please note that SCON does not have a collision prevention mechanism)



Note

(Note 1) For the relationship between acceleration and payload capacity, see page 4.
(Note 2) The values shown are payload capacities during operation at maximum speed.
(Note 3) For a 10,000-km running life.
(Note 4) The maximum cable length is 30 m. Please specify length in meters.
(E.g., X08 = 8 m)

NS-LXMS

Single-Axis Robot Large Nut Rotation Type Main Unit Width 145mm 400W
Horizontal Type Single Slider



Model	NS	LXMS		400			T2		AQ		RT
Series	Type	Encoder Type	Motor Type	Lead	Stroke	Applicable controller	Cable Length	Option			
		A: Absolute I: Incremental	400: 400W	40: 40mm 20: 20 mm	500: 500mm T2: SCON SSEL XSEL-P/Q 2200: 2,200mm	N: No S: 3m M: 5m X□□: Length Specified		See the options table below			

Model/Specification

Model	Encoder Type	Motor Output (W)	Lead (mm)	Stroke (mm)	Speed (mm/s)	Acceleration (Note 1)				Payload capacity (Note 1 & 2)				Rated Thrust (N)
						Horizontal (G)		Vertical (G)		Horizontal (kg)		Vertical (kg)		
						Rated	Maximum	Rated	Maximum	Rated	Maximum	Rated	Maximum	
NS-LXMS-①-400-40-②-T2-③-AQ-④-RT	Absolute	400	40	500~2200	2400	0.3	1.0	Horizontal Only		40	10	Horizontal Only		170
NS-LXMS-①-400-20-②-T2-③-AQ-④-RT	Incremental		20		1300	0.3	1.0			80	24			340.1

*In the model above, ① indicates the type of encoder, ② indicates the stroke, ③ indicates the cable length, and ④ indicates the option.

Option

Name	Model	Reference page	Note
AQ Seal	AQ	→P5	Standard Equipment
Creep Sensor	C	→P5	
Installation Direction of Standard Cable Track	CT1-CT4	→P5	Enter CT1 for standard installation
Installation Direction of Extended Cable Track	ET1-ET4	→P5	
Limit Switch	L	→P6	
Guide with Ball-Retaining Mechanism	RT	→P6	Standard Equipment

Common specifications

Driving Method	Ball Thread, Diameter φ20 mm, Equivalent to Rolled C5
Repeated Positioning Accuracy	+/- 0.01 mm
Backlash	0.02 mm or less
Guide	Integrated to Base
Dynamic Allowable Moment (Note 3)	Ma: 104.9N·m, Mb: 149.9N·m, Mc: 248.9N·m
Overhung load length	Ma Direction: 750 mm or less; Mb and Mc Direction: 750 mm or less
Base	Material: Aluminium, White Alumite Treatment
Cable Length (Note 4)	N: No cable; S: 3 m; M: 5 m; X□□: Length specified
Ambient Temperature	0~40 degrees Celsius, 85% RH or less (No condensation)

Dimensional drawing

The CAD drawings can be downloaded from our homepage.



*1 Connects motor cables and encoder cables.
For details on cables, please see page 22.

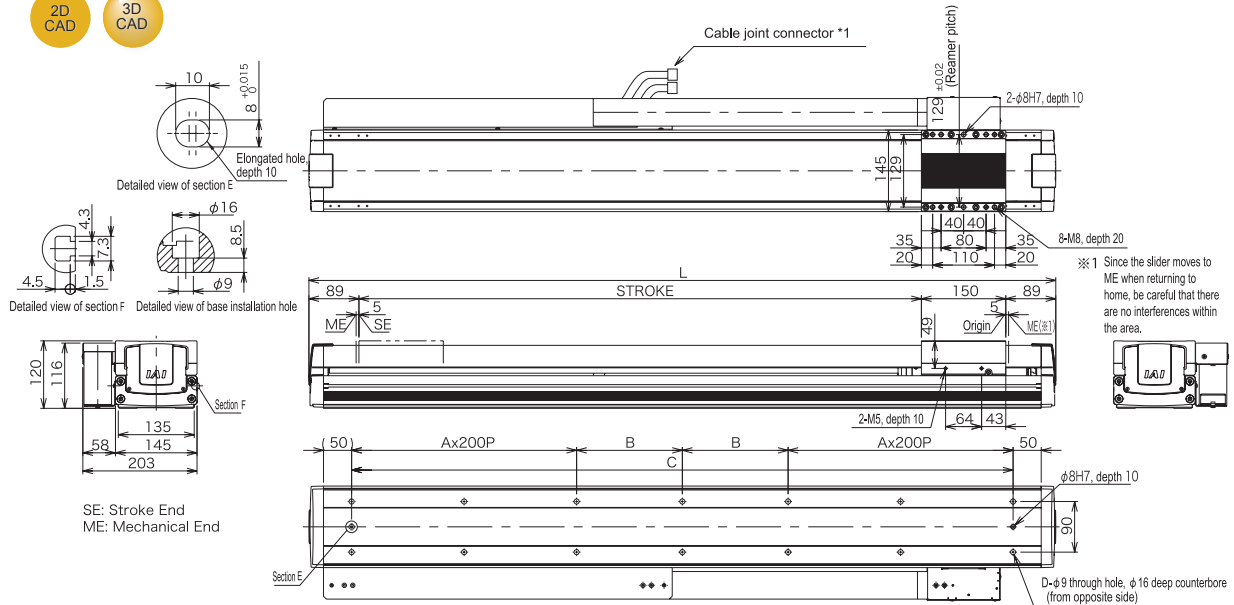

*For the internal dimensions of the cable track, please see page 6.

Stroke	500	600	700	800	900	1000	1100	1200	1300	1400	1500	1600	1700	1800	1900	2000	2100	2200
L	828	928	1028	1128	1228	1328	1428	1528	1628	1728	1828	1928	2028	2128	2228	2328	2428	2528
A	1	1	1	1	2	2	2	2	3	3	3	3	4	4	4	4	5	5
B	138	188	238	288	338	388	438	488	538	588	638	688	738	788	838	888	938	988
C	676	776	876	976	1076	1176	1276	1376	1476	1576	1676	1776	1876	1976	2076	2176	2276	2376
D	10	10	10	10	14	14	14	14	18	18	18	18	22	22	22	22	26	26
Mass (kg)	18.6	20.1	21.6	23.1	24.5	26.0	27.5	29.0	30.5	32.0	33.5	35.0	36.5	38.0	39.5	41.0	42.5	43.9

Applicable Controller Specifications

Applicable Controller	Max. Number of Axes Controlled	Compatible Encoder Type	Operation Method	Power/Voltage
X-SEL-P/Q	6 axis	Absolute/ Incremental	Programs	Three-Phase/ Single-Phase 200VAC
SSEL	2 axis		Position/Pulse Train Control	Single-Phase 100/200VAC
SCON	1 axis			



Note

(Note 1) For the relationship between acceleration and payload capacity, see page 4.
 (Note 2) The values shown are payload capacities during operation at maximum speed.
 (Note 3) For a 10,000-km running life.
 (Note 4) The maximum cable length is 30 m. Please specify length in meters.
 (E.g., X08 = 8 m)
 (Note 5) When an axis with a long stroke (1,300 mm or more) is used hanging from the ceiling, the cover of the body may hang down and contact the slider. Therefore, in cases of such use, please contact our sales representative in advance.

NS-LXMM

Single-Axis Robot Large Nut Rotation Type Main Unit Width 145mm 400W
Horizontal Type Multi-Slider



■Model **NS-LXMM** - [] - **400** - [] - [] - **T2** - [] - **AQ** - [] - **RT**

Series	Type	Encoder Type	Motor Type	Lead	Stroke	Applicable controller	Cable Length	Option
		A: Absolute I: Incremental	400: 400W	40: 40mm 20: 20 mm	250: 250mm 2250: 2,250mm	T2: SCON SSEL XSEL-P/Q	N: No S: 3m M: 5m X□: Length Specified	See the options table below

Model/Specification

Model	Encoder Type	Motor Output (W)	Lead (mm)	Stroke (mm)	Speed (mm/s)	Acceleration (Note 1)				Payload capacity (Note 1 & 2)				Rated Thrust (N)
						Horizontal (G)		Vertical (G)		Horizontal (kg)		Vertical (kg)		
						Rated	Maximum	Rated	Maximum	Rated	Maximum	Rated	Maximum	
NS-LXMM-[]-400-40-[]-T2-[]-AQ-[]-RT	Absolute	400	40	250~2250	2400	0.3	1.0	Horizontal Only		40	10	Horizontal Only		170
NS-LXMM-[]-400-20-[]-T2-[]-AQ-[]-RT	Incremental		20		1300	0.3	1.0			80	24			340.1

*In the model above, [1] indicates the type of encoder, [2] indicates the stroke, [3] indicates the cable length, and [4] indicates the option.

Option

Name	Model	Reference page	Note
AQ Seal	AQ	→P5	Standard Equipment
Creep Sensor	C	→P5	
Standard/Extended Cable Track Selection	CT1/ET1	→P5	Enter CT1 for Standard Cable Track
Limit Switch	L	→P6	
Guide with Ball-Retaining Mechanism	RT	→P6	Standard Equipment

Common specifications

Driving Method	Ball Thread, Diameter φ20 mm, Equivalent to Rolled C5
Repeated Positioning Accuracy	+/- 0.01 mm
Backlash	0.02 mm or less
Guide	Integrated to Base
Dynamic Allowable Moment (Note 3)	Ma: 104.9N·m, Mb: 149.9N·m, Mc: 248.9N·m
Overhung load length	Ma Direction: 750 mm or less; Mb and Mc Direction: 750 mm or less
Base	Material: Aluminium, White Alumite Treatment
Cable Length (Note 4)	N: No cable; S: 3 m; M: 5 m; X□: Length specified
Ambient Temperature	0~40 degrees Celsius, 85% RH or less (No condensation)

Dimensional drawing

The CAD drawings can be downloaded from our homepage.



*1 Connects motor cables and encoder cables.
For details on cables, please see page 22.

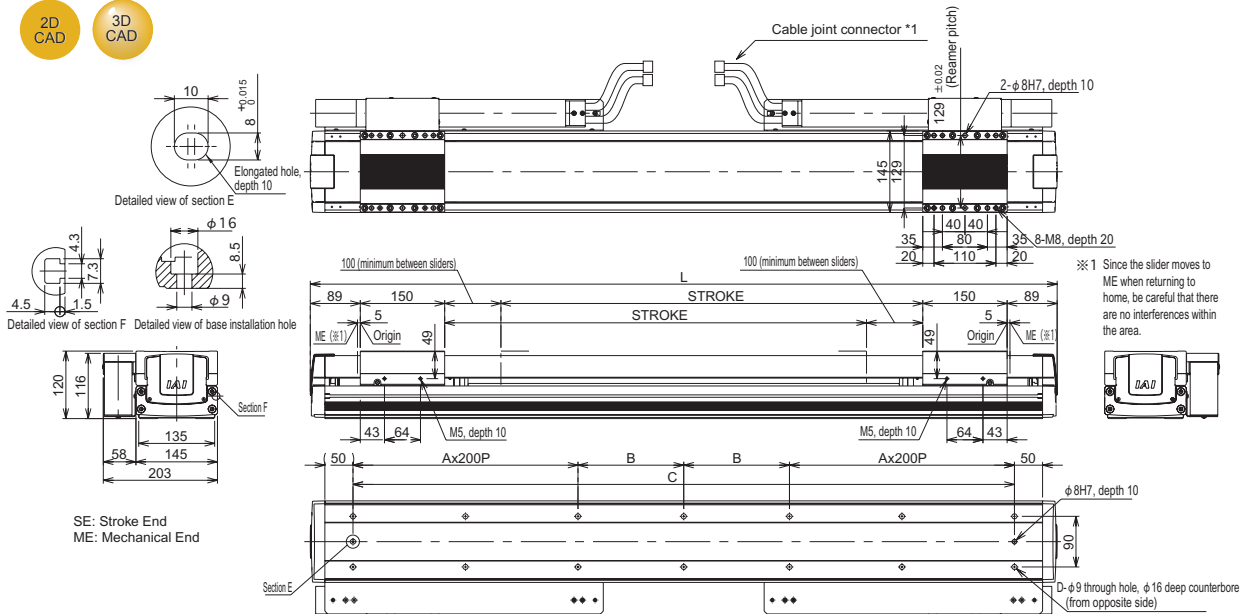

*For the internal dimensions of the cable track, please see page 6.

Stroke	250	350	450	550	650	750	850	950	1050	1150	1250	1350	1450	1550	1650	1750	1850	1950	2050	2150	2250
L	828	928	1028	1128	1228	1328	1428	1528	1628	1728	1828	1928	2028	2128	2228	2328	2428	2528	2628	2728	2828
A	1	1	1	1	2	2	2	2	3	3	3	4	4	4	4	5	5	5	5	5	6
B	138	188	238	288	338	388	438	488	538	588	638	688	738	788	838	888	938	988	1038	1088	1138
C	676	776	876	976	1076	1176	1276	1376	1476	1576	1676	1776	1876	1976	2076	2176	2276	2376	2476	2576	2676
D	10	10	10	10	14	14	14	14	18	18	18	18	22	22	22	22	26	26	26	26	30
Mass (kg)	24.7	26.4	28.2	29.9	31.6	33.4	35.1	36.8	38.6	40.3	42	43.8	45.5	47.2	48.9	50.7	52.4	54.1	55.9	57.6	59.3

Applicable Controller Specifications

Applicable Controller	Max. Number of Axes Controlled	Compatible Encoder Type	Operation Method	Power/Voltage
X-SEL-P/Q	6 axis	Absolute/ Incremental	Programs Positioner/Pulse Train Control	Three-Phase/ Single-Phase 200VAC
SSEL	2 axis			Single-Phase 100/200VAC
SCON	1 axis			

Note: A two-axis controller is required to operate the multi-slider.
Two controllers are required for SCON.
(Please note that SCON does not have a collision prevention mechanism)



Note

(Note 1) For the relationship between acceleration and payload capacity, see page 4.
 (Note 2) The values shown are payload capacities during operation at maximum speed.
 (Note 3) For a 10,000-km running life.
 (Note 4) The maximum cable length is 30 m. Please specify length in meters.
 (E.g., X08 = 8 m)
 (Note 5) When an axis with a long stroke (1,300 mm or more) is used hanging from the ceiling, the cover of the body may hang down and contact the slider. Therefore, in cases of such use, please contact our sales representative in advance.

NS-LXMXS Single-Axis Robot Large Nut Rotation Type Main Unit Width 145mm 400W Horizontal Type With Mid-Support Single Slider



■ Model **NS-LXMXS-□-400-□-□-T2-□-AQ-□-RT**

Series	Type	Encoder Type	Motor Type	Lead	Stroke	Applicable controller	Cable Length	Option
NS	LXMXS	A: Absolute I: Incremental	400: 400W	40: 40mm 20: 20mm	2300: 2,300mm 3000: 3,000mm	T2: SCON SSEL XSEL-P/Q	N: No S: 3m M: 5m X□□: Length Specified	See the options table below

Model/Specification

Model	Encoder Type	Motor Output (W)	Lead (mm)	Stroke (mm)	Speed (mm/s)	Acceleration (Note 1)				Payload capacity (Note 1 & 2)				Rated Thrust (N)
						Horizontal (G)		Vertical (G)		Horizontal (kg)		Vertical (kg)		
						Rated	Maximum	Rated	Maximum	Rated	Maximum	Rated	Maximum	
NS-LXMXS-①-400-40-②-T2-③-AQ-④-RT	Absolute	400	40	2300-3000	2400	0.3	Horizontal Only		40	Horizontal Only		170		
NS-LXMXS-①-400-20-②-T2-③-AQ-④-RT	Incremental		20		1300	0.3			80			340.1		

*In the model above, ① indicates the type of encoder, ② indicates the stroke, ③ indicates the cable length, and ④ indicates the option.

Option

Name	Model	Reference page	Note
AQ Seal	AQ	→P5	Standard Equipment
Creep Sensor	C	→P5	
Installation Direction of Standard Cable Track	CT1-CT4	→P5	Enter CT1 for standard installation
Installation Direction of Extended Cable Track	ET1-ET4	→P5	
Limit Switch	L	→P6	
Guide with Ball-Retaining Mechanism	RT	→P6	Standard Equipment

Common specifications

Driving Method	Ball Thread, Diameter φ20 mm, Equivalent to Rolled C5
Repeated Positioning Accuracy	±0.01mm
Backlash	0.02 mm or less
Guide	Integrated to Base
Dynamic Allowable Moment (Note 3)	Ma: 104.9N·m, Mb: 149.9N·m, Mc: 248.9N·m
Overhung load length	Ma Direction: 750 mm or less; Mb and Mc Direction: 750 mm or less
Base	Material: Aluminium, White Alumite Treatment
Cable Length (Note 4)	N: No cable; S: 3 m; M: 5 m; X□□: Length specified
Ambient Temperature	0~40 degrees Celsius, 85% RH or less (No condensation)

Dimensional drawing

The CAD drawings can be downloaded from our homepage.



*1 Connects motor cables and encoder cables. For details on cables, please see page 22.

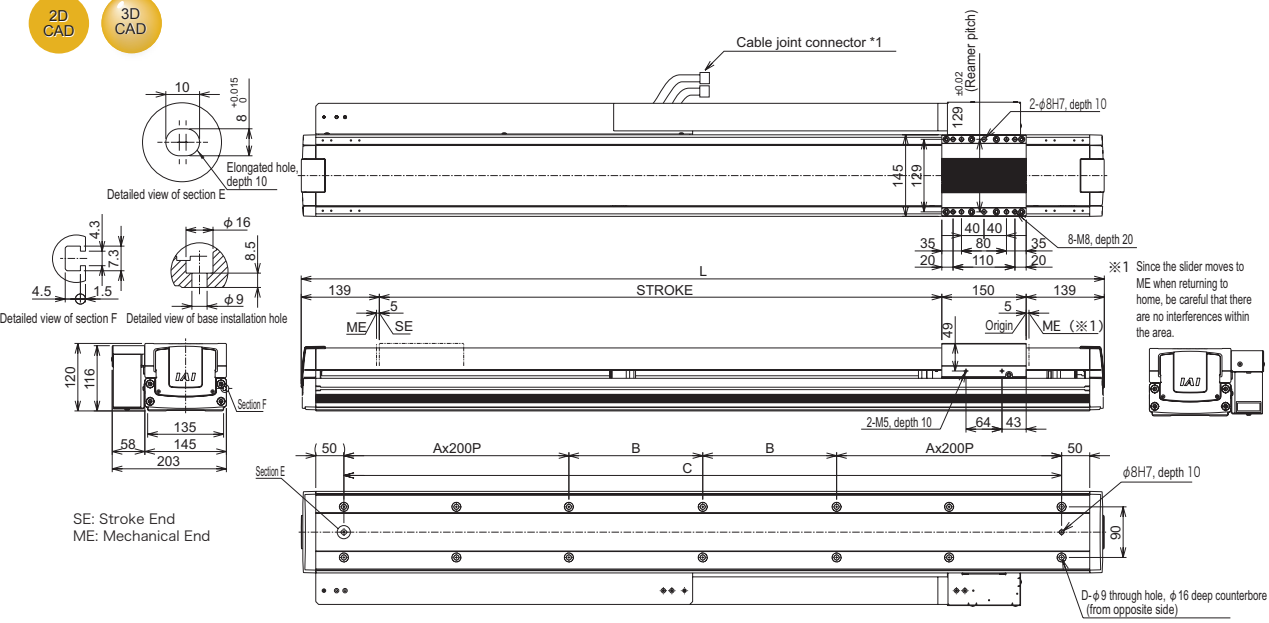

Note: Due to their structure, models with a mid-support cannot be positioned horizontally on their side or vertically.

*For the internal dimensions of the cable track, please see page 6.

Stroke	2300	2400	2500	2600	2700	2800	2900	3000
L	2728	2828	2928	3028	3128	3228	3328	3428
A	5	6	6	6	6	7	7	7
B	288	138	188	238	288	138	188	238
C	2576	2676	2776	2876	2976	3076	3176	3276
D	26	30	30	30	30	34	34	34
Mass (kg)	46.4	47.9	49.4	50.9	52.3	53.8	55.3	56.8

Applicable Controller Specifications

Applicable Controller	Max. Number of Axes Controlled	Compatible Encoder Type	Operation Method	Power/Voltage
X-SEL-P/Q	6 axis	Absolute/ Incremental	Programs	Three-Phase/ Single-Phase 200VAC
SSEL	2 axis			Single-Phase 100/200VAC
SCON	1 axis		Positioner Pulse Train Control	

! Note

(Note 1) The maximum acceleration is 0.3 G.
 (Note 2) The values shown are payload capacities during operation at maximum speed.
 (Note 3) For a 10,000-km running life.
 (Note 4) The maximum cable length is 30 m. Please specify length in meters. (E.g., X08 = 8 m)
 (Note 5) When an axis with a long stroke (1,300 mm or more) is used hanging from the ceiling, the cover of the body may hang down and contact the slider. Therefore, in cases of such use, please contact our sales representative in advance.

NS-LZMS

Single-Axis Robot Large Nut Rotation Type Main Unit Width 145mm 400W
Vertical Type Single Slider



■ Model **NS-LZMS-□-400-□-□-T2-□-AQ-B-□-RT**

Series	Type	Encoder Type	Motor Type	Lead	Stroke	Applicable controller	Cable Length	Option
NS	LZMS	A: Absolute I: Incremental	400: 400W	20: 20 mm	500: 500mm 1000: 1,000mm	T2: SCON SSEL XSEL-P/Q	N: No S: 3m M: 5m X□: Length Specified	See the options table below

Model/Specification

Model	Encoder Type	Motor Output (W)	Lead (mm)	Stroke (mm)	Speed (mm/s)	Acceleration (Note 1)				Payload capacity (Note 1 & 2)				Rated Thrust (N)
						Horizontal (G)		Vertical (G)		Horizontal (kg)		Vertical (kg)		
						Rated	Maximum	Rated	Maximum	Rated	Maximum	Rated	Maximum	
NS-LZMS-①-400-20-②-T2-③-AQ-B-④-RT	Absolute Incremental	400	20	500~1000	1000	Vertical Only		0.3	0.8	Vertical Only	16	6.0	340.1	

*In the model above, ① indicates the type of encoder, ② indicates the stroke, ③ indicates the cable length, and ④ indicates the option.

Option

Name	Model	Reference page	Note
AQ Seal	AQ	→P5	Standard Equipment
Brake (*)	B	→P5	Standard Equipment
Creep Sensor	C	→P5	
Installation Direction of Standard Cable Track	CT1-CT4	→P5	Enter CT1 for standard installation
Installation Direction of Extended Cable Track	ET1-ET4	→P5	
Limit Switch	L	→P6	
Guide with Ball-Retaining Mechanism	RT	→P6	Standard Equipment

(*) A brake box is attached for powering the brake. (For details, see page 21)

Common specifications

Driving Method	Ball Thread, Diameter φ20 mm, Equivalent to Rolled C5
Repeated Positioning Accuracy	±0.01mm
Backlash	0.02 mm or less
Guide	Integrated to Base
Dynamic Allowable Moment (Note 3)	Ma: 104.9N·m; Mb: 149.9N·m; Mc: 248.9N·m
Overhung load length	Ma Direction: 750 mm or less; Mb and Mc Direction: 750 mm or less
Brake	Non-excitation electromagnetic brakes are installed as standard equipment
Base	Material: Aluminium, White Alumite Treatment
Cable Length (Note 4)	N: No cable; S: 3 m; M: 5 m; X□: Length specified
Ambient Temperature	0~40 degrees Celsius, 85% RH or less (No condensation)

Dimensional drawing

The CAD drawings can be downloaded from our homepage.

*1 Connects motor cables and encoder cables.
For details on cables, please see page 22.

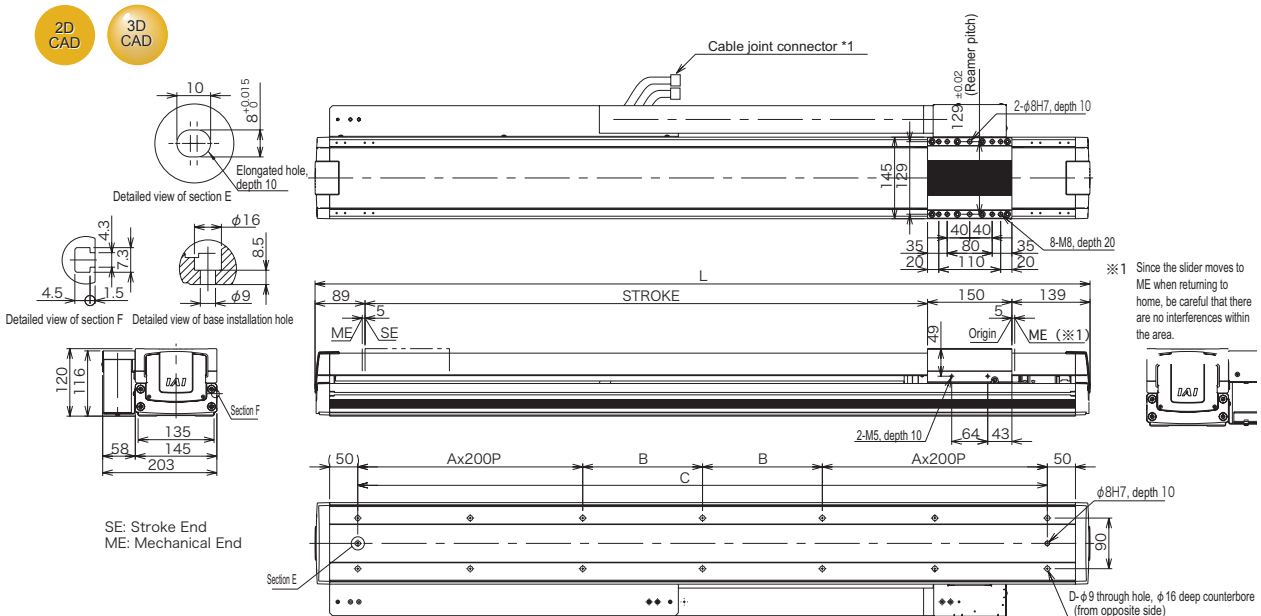

※1 Since the slider moves to ME when returning to home, be careful that there are no interferences within the area.

*For the internal dimensions of the cable track, please see page 6.

Stroke	500	600	700	800	900	1000
L	878	978	1078	1178	1278	1378
A	1	1	1	2	2	2
B	163	213	263	113	163	213
C	726	826	926	1026	1126	1226
D	10	10	10	14	14	14
Mass (kg)	19.9	21.4	22.9	24.4	25.9	27.4

Applicable Controller Specifications

Applicable Controller	Max. Number of Axes Controlled	Compatible Encoder Type	Operation Method	Power/Voltage
X-SEL-P/Q	6 axis	Absolute/Incremental	Programs	Three-Phase/Single-Phase 200VAC
SSEL	2 axis		Positioner Pulse Train Control	Single-Phase 100/200VAC
SCON	1 axis			



Note

(Note 1) For the relationship between acceleration and payload capacity, see page 4.
 (Note 2) The values shown are payload capacities during operation at maximum speed.
 (Note 3) For a 10,000-km running life.
 (Note 4) The maximum cable length is 30 m. Please specify length in meters.
 (E.g., X08 = 8 m)

NS-LZMM

Single-Axis Robot Large Nut Rotation Type Main Unit Width 145mm 400W
Vertical Type Multi-Slider



■ Model **NS-LZMM** - [] - **400** - [] - [] - **T2** - [] - **AQ** - **B** - [] - **RT**

Series	Type	Encoder Type	Motor Type	Lead (mm)	Stroke	Applicable controller	Cable Length
A: Absolute	400: 400W	20: 20 mm	250: 250mm	T2: SCON	N: No	S: 3m	
I: Incremental			950: 950 mm	SSEL	XSEL-P/Q	M: 5m	X□: Length Specified

See the options table below

Model/Specification

Model	Encoder Type	Motor Output (W)	Lead (mm)	Stroke (mm)	Speed (mm/s)	Acceleration (Note 1)				Payload capacity (Note 1 & 2)				Rated Thrust (N)
						Horizontal (G)		Vertical (G)		Horizontal (kg)		Vertical (kg)		
						Rated	Maximum	Rated	Maximum	Rated	Maximum	Rated	Maximum	
NS-LZMM-①-400-20-②-T2-③-AQ-B-④-RT	Absolute Incremental	400	20	250-950	1000	Vertical Only	0.3	0.8	Vertical Only	16	6.0	340.1		

*In the model above, ① indicates the type of encoder, ② indicates the stroke, ③ indicates the cable length, and ④ indicates the option.

Option

Name	Model	Reference page	Note
AQ Seal	AQ	→P5	Standard Equipment
Brake (*)	B	→P5	Standard Equipment
Creep Sensor	C	→P5	
Standard/Extended Cable Track Selection	CT1/ET1	→P5	Enter CT1 for Standard Cable Track
Limit Switch	L	→P6	
Guide with Ball-Retaining Mechanism	RT	→P6	Standard Equipment

(*) A brake box is attached for powering the brake.
(For details, see page 21)

Common specifications

Driving Method	Ball Thread, Diameter φ20 mm, Equivalent to Rolled C5
Repeated Positioning Accuracy	±0.01mm
Backlash	0.02 mm or less
Guide	Integrated to Base
Dynamic Allowable Moment (Note 3)	Ma: 104.9N·m; Mb: 149.9N·m; Mc: 248.9N·m
Overhung load length	Ma Direction: 750 mm or less; Mb and Mc Direction: 750 mm or less
Brake	Non-excitation electromagnetic brakes are installed as standard equipment
Base	Material: Aluminium, White Alumite Treatment
Cable Length (Note 4)	N: No cable; S: 3 m; M: 5 m; X□: Length specified
Ambient Temperature	0~40 degrees Celsius, 85% RH or less (No condensation)

Dimensional drawing

The CAD drawings can be downloaded from our homepage.

*1 Connects motor cables and encoder cables.
For details on cables, please see page 22.

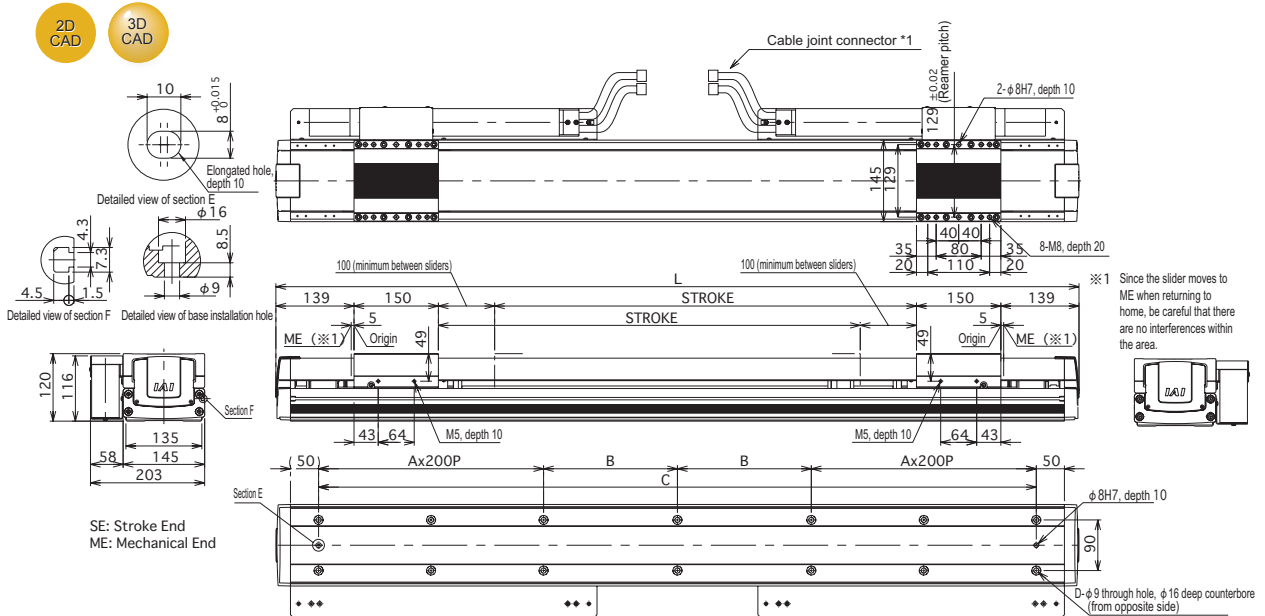

*For the internal dimensions of the cable track, please see page 6.

Stroke	250	350	450	550	650	750	850	950
L	928	1028	1128	1228	1328	1428	1528	1628
A	1	1	1	2	2	2	2	3
B	188	238	288	138	188	238	288	138
C	776	876	976	1076	1176	1276	1376	1476
D	10	10	10	14	14	14	14	18
Mass (kg)	27.1	28.8	30.5	32.2	34	35.7	37.4	39.2

Applicable Controller Specifications

Applicable Controller	Max. Number of Axes Controlled	Compatible Encoder Type	Operation Method	Power/Voltage
X-SEL-P/Q	6 axis	Absolute/Incremental	Programs Positioner Pulse Train Control	Three-Phase/ Single-Phase 200VAC
SSEL	2 axis			Single-Phase 100/200VAC
SCON	1 axis			





Note: A two-axis controller is required to operate the multi-slider.
Two controllers are required for SCON.
(Please note that SCON does not have a collision prevention mechanism)



Note

(Note 1) For the relationship between acceleration and payload capacity, see page 4.
(Note 2) The values shown are payload capacities during operation at maximum speed.
(Note 3) For a 10,000-km running life.
(Note 4) The maximum cable length is 30 m. Please specify length in meters.
(E.g., X08 = 8 m)

Controller

	Controller Series/Type	SCON	SSEL	XSEL		
				P (Standard) Type	Q (Global) Type	
Basic Specifications	Form					
	Power Capacity	Maximum: 844VA	Maximum: 1660VA (For 400W 2-axis operation)	Maximum: 4988VA (For 6-axis operation total of 2400W)		
	Input Power	Single-Phase AC 200V	Single-Phase AC 100V Single-Phase AC 200V	Three-Phase AC 200V Single-Phase AC 200V		
	Range of Operating Power Voltages	±10%				
Control Specifications	Maximum total connected axes output (W)	750W(for 200V power supply)	400W(for 100V power supply) 800W(for 200V power supply)	2,400W(For three-phase) 1,600W(For single-phase)		
	Max. Number of Axes Controlled	1 axis	2 axis	6 axis		
	Position Detection Method	Incremental Encoder/Absolute Encoder				
	Safety Circuit Configuration	Duplexing not possible		Duplexing not possible	Duplexing possible	
	Operation Method	Positioner Operation Pulse Train Control	Program Operation Positioner Operation (Switchable)	Program Operation Only		
Programs	Number of Programs	—	—	128		
	Number of Program Steps	—	—	9999		
	Number of Multi-Task Programs	—	8	16		
	Number of Positions	Maximum: 512	—	20000		
	Data Input Device (Optional)	Teaching Box Model: CON-T/RCM-E PC-Supported Soft ware Model: RCM-101-MW (For RS232 Communication) RCM-101-USB (For USB Communication)	Teaching Box Model: SEL-T-J/SEL-TD-J PC-Supported Soft ware Model: IA-101-X-MW-J (For RS232 Communication) IA-101-X-USB (For USB Communication)	Teaching Box Model: SEL-T/SEL-TD PC-Supported Soft ware Model: IA-101-X-MW (For RS232 Communication) IA-101-X-USBMW (For USB Communication)	Teaching Box Model: SEL-TD PC-Supported Soft ware Model: IA-101-XA-MW (With RS232 Communication) Safety Category-Supported Cable)	
Input/Output and Communication	Standard Input/Output	Input: 16 points/Output: 16 points (NPN/PNP Selection Allowed)	Input: 24 points/Output: 8 points (NPN/PNP Selection Allowed)	Input: 32 points/Output: 16 points (NPN/PNP Selection Allowed)		
	Expanded Input/Output	Not Possible			Maximum Input: 192 Maximum Output: 192	
	Field Network	DeviceNet, CC-Link, Profibus	(Will be supported)	DeviceNet, CC-Link, Profibus, Ethernet		
General Specifications	Ambient Temperature/Humidity during Operation	0~40°C 10~95%(No condensation)				
	Ambient Air during Operation	No Corrosive gas. Especially no dust.				
	Outer Dimensions	72(W)×200.5(H)×121(D)	100(W)×202.6(H)×126(D) When the absolute battery is installed	340(W)×195(H)×125.3(D) (For 6-axis absolute specification)		
	Mass	1.1 kg	1.4kg	5.7kg(For 6-axis absolute specification)		
	Attachments	I/OFlat Cable(40 Cores)	I/OFlat Cable(34 Cores)	I/OFlat Cable(50 Cores)		

■ Brake Box (Attachment)

With the vertical types (MZMS/MZMM/LZMS/LZMM), this device must be installed while wiring the encoder between the controller and the actuator.

*This is not necessary with SZMS/SZMM.

(Attachment for models with brakes)

Model: RCB-110-RA13-0

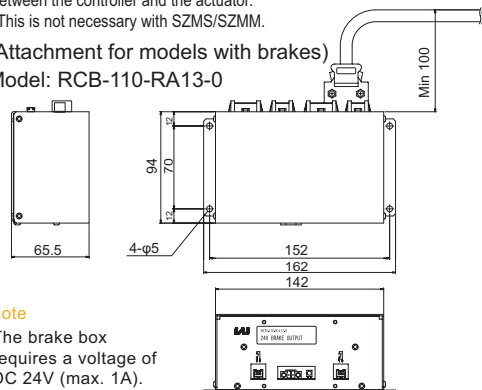

Note

The brake box requires a voltage of DC 24V (max. 1A).

■ Regenerative Resistance Unit (Optional)

■ Features This unit converts the regenerative current from a decelerating motor into heat. Refer to the following table to determine the required number of regenerative resistors according to the total wattage of the actuator.

■ Models REU-1 (for XSEL)
REU-2 (for SCON/SSEL)

	Horizontal			Vertical		
	XSEL	SSEL	SCON	XSEL	SSEL	SCON
0	~100W	~200W	~100W	~100W	~200W	~100W
1	~500W	~800W	~400W	~800W	~600W	~400W
2	~800W			~1200W	~800W	~750W
3	~1200W			~1600W		
4	~2000W			~2000W		
5	~2400W			~2400W		

*Depending on the operating conditions, the number of regenerative resistors required may be larger than the number listed in the table above.

*If two regenerative resistance units are required for SCON/SSEL, use model REU-1 as the second unit.

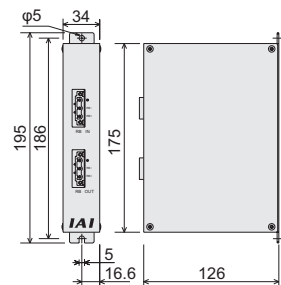

Maintenance Parts

Motor cable (for XSEL-KE/KT/P/Q, SSEL, SCON) * (see fig. below)

Model **CB-XEU-MA**□□□□

(*EU": standard cable option, see fig. down)

Enter the cable length (L) at □□□. Up to 30 meters is supported. Example: 080=8 m

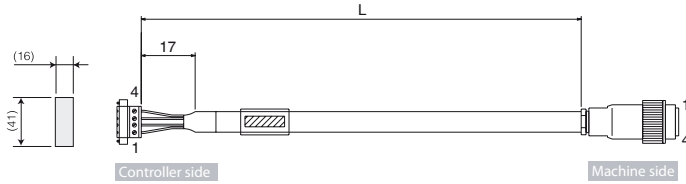

Wire	Color	Signal	No.	No.	Signal	Color	Wire
0.75sq	Green	PE	1	1	U	Red	0.75sq (press fit)
	Red	U	2	2	V	White	
	White	V	3	3	W	Black	
	Black	W	4	4	PE	Green	

Encoder cable (for XSEL-P/Q, SSEL, SCON)

Model **CB-X3EU-PA**□□□□

(*EU": standard cable option, see fig. down)

Enter the cable length (L) at □□□. Up to 30 meters is supported. Example: 080=8 m

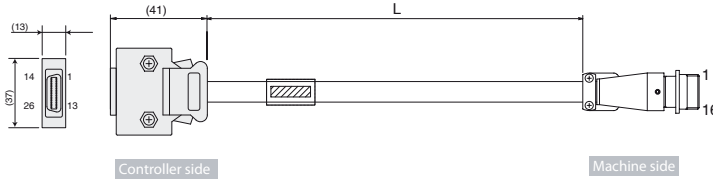

Wire	Color	Signal	No.	No.	Signal	Color	Wire
—	—	—	10	1	A	White/blue	AWG26 (press fit)
—	—	—	11	2	A	White/yellow	
—	E24V	—	12	3	B	White/red	
—	0V	—	13	4	B	White/black	
—	LS	—	26	5	Z	White/purple	
—	CLEEP	—	25	6	Z	White/gray	
—	OT	—	24	—	—	—	
—	RSV	—	23	—	—	—	
—	—	—	9	7	FG	Drain	
—	—	—	18	8	S D	Orange	
—	—	—	19	9	S D	Green	
White/blue	A+	—	1	10	B A T +	Purple	
White/yellow	A-	—	2	11	B A T -	Gray	
White/red	B+	—	3	12	V C C	Red	
White/black	B-	—	4	13	G N D	Black	
White/purple	Z+	—	5	14	—	—	
White/gray	Z-	—	6	15	B K -	Blue	
Orange	SRD+	—	7	16	B K +	Yellow	
Green	SRD-	—	8	—	—	—	
Purple	B A T +	—	14	—	—	—	
Gray	B A T -	—	15	—	—	—	
Red	V C C	—	16	—	—	—	
Black	G N D	—	17	—	—	—	
Blue	BKR-	—	20	—	—	—	
Yellow	BKR+	—	21	—	—	—	
—	—	—	22	—	—	—	

The shield is clamped to the hood.
Drain line and shield braid
(The wire colors white/blue show the band color/insulation color)

Encoder cable (for XSEL-P/Q, SSEL, SCON, specifications with limit switch)

Model **CB-X3EU-PLA**□□□□

(*EU": standard cable option, see fig. down)

Enter the cable length (L) at □□□. Up to 30 meters is supported. Example: 080=8 m

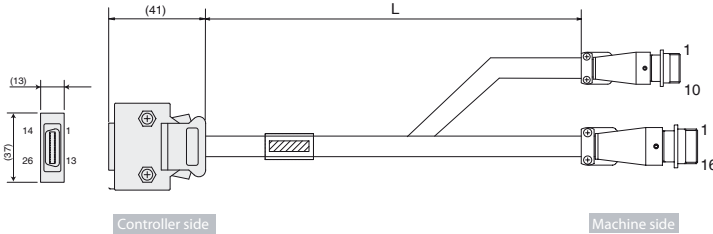

Wire	Color	Signal	No.	No.	Signal	Color	Wire
—	—	—	10	1	E24V	White/orange	AWG26 (press fit)
White/orange	E24V	—	12	2	OV	White/green	
White/green	OV	—	13	3	LS	Brown/black	
Brown/black	LS	—	26	4	CLEEP	Brown/black	
Brown/yellow	CLEEP	—	25	5	OT	Brown/red	
Brown/red	OT	—	24	6	RSV	Brown/black	
—	—	—	9	—	—	—	
—	—	—	18	—	—	—	
—	—	—	19	—	—	—	
White/blue	A+	—	1	2	A	White/blue	AWG26 (press fit)
White/yellow	A-	—	2	3	B	White/red	
White/red	B+	—	3	4	B	White/black	
White/black	B-	—	4	5	Z	White/purple	
White/purple	Z+	—	5	6	Z	White/gray	
White/gray	Z-	—	6	—	—	—	
Orange	SRD+	—	7	—	—	—	
Green	SRD-	—	8	7	FG	Drain	
Purple	B A T +	—	14	8	S D	Orange	
Gray	B A T -	—	15	9	S D	Green	
Red	V C C	—	16	10	B A T +	Purple	
Black	G N D	—	17	11	B A T -	Gray	
Blue	BKR-	—	20	12	V C C	Red	
Yellow	BKR+	—	21	13	G N D	Black	
—	—	—	22	14	—	—	
—	—	—	—	15	B K -	Blue	
—	—	—	—	16	B K +	Yellow	

The shield is clamped to the hood.
Drain line and shield braid
(The wire colors white/blue show the band color/insulation color)



NS Series V4
Catalogue No. 0709-E

The information contained in this catalog is
subject to change without notice for the purpose
of product improvement



Providing quality products
since 1986



IAI Industrieroboter GmbH
Ober der Röth 4
D-65824 Schwalbach / Frankfurt
Germany
Tel.:+49-6196-8895-0
Fax:+49-6196-8895-24
E-Mail: info@IAI-GmbH.de
Internet: <http://www.eu.IAI-GmbH.de>

IAI America, Inc.
2690 W. 237th Street
Torrance, CA 90505, U.S.A.
Phone: +1-310-891-6015
Fax: +1-310-891-0815

IAI (Shanghai) Co., Ltd.
Shanghai Jiahua B. C. A8404.808
Hongqiao Rd., Shanghai 200030, China
Phone: +86-21-6448-4753
Fax: +86-21-6448-3992

IAI CORPORATION
645-1 Shimizu Hirose
Shizuoka 424-0102, Japan
Phone: +81-543-64-5105
Fax: +81-543-64-5182