

FS Actuator Operating Manual

===== Seventh Edition =====

Body width 40mm	FS-N
Body width 52mm	FS-W
Body width 75mm	FS-L

Please Read Before Use

Thank you for purchasing our product.

This Operation Manual describes all necessary information to operate this product safely such as the operation procedure, structure and maintenance procedure.

Before operation, read this manual carefully and fully understand it to operate this product safely. The DVD that comes with the product contains operation manuals for IAI products.

For a use of the products, print out or display on your personal computer the necessary pages of the applicable Operation Manuals.

After reading the Operation Manuals, be sure to keep them in a convenient place easily accessible to the personnel using this product.

[Important]

- This Operation Manual is original.
- This product is not to be used for any other purpose from what is noted in this Operation Manual. IAI shall not be liable whatsoever for any loss or damage arising from the result of using the product for any other purpose from what is noted in the manual.
- The information contained in this Operation Manual is subject to change without notice for the purpose of production improvement.
- If you have any question or finding regarding the information contained in this Operation Manual, contact our customer center or our sales office near you.
- Using or copying all or a part of this Operation Manual without permission is prohibited.
- The company names, names of products and trademarks of our company shown in the sentences are registered trademarks.

CE Marking

If a compliance with the CE Marking is required, please follow Overseas Standards Compliance Manual (ME0287) that is provided separately.

Table of Contents

Safety Guide	1
Caution in Handling	8
Names of the Parts	9
1. Specifications Check	11
1.1 Product Check	11
1.1.1 Parts	11
1.1.2 Operation Manuals related to this product, which are contained in the DVD.	12
1.1.3 How to read the model plate	13
1.1.4 How to read the model No.	14
1.2. Specification	15
1.3. Option	17
1.3.1 Reversed-home type	17
1.4. Motor • Encoder Cables	18
1.4.1 Motor Cable (For XSEL-J/K/P/Q, SSEL and SCON) CB-X-MA□□□	18
1.4.2 Encoder Cable (For XSEL-J/K) CB-X-PA□□□	18
1.4.3 Limit Switch Cable (For XSEL-J/K) CB-X-LC□□□	19
1.4.4 Encoder Cable (For XSEL-P/Q, SSEL, SCON and LS equipped type connection) CB-X1-PLA□□□	19
2. Installation	20
2.1 Transportation	20
2.2 Installation and Storage • Preservation Environment	22
2.3 How to Install	23
2.3.1 Orientation of the Actuator Installation	23
2.3.2 Installation	24
3. Connection to the Controller	26
4. Setting the Home Position	30
5. Maintenance Inspection	32
5.1 Inspection Items and Inspection Schedule	32
5.2 Visual inspection	32
5.3 Cleaning	32
5.4 Inside Visual Inspection	33
5.5 Internal Cleanup	33
5.6 Grease Supply	34
5.7 Driving Belt Replacement	35
5.8 How to Replace the Deceleration Belt	48
5.9 Motor Replacement	54

6.	External Dimensions	64
6.1	FS-11NM-60 (Single Slider), FS-12NM-60 (Double Slider)	64
6.2	FS-11NM-100 (Single Slider), FS-12NM-100 (Double Slider)	65
6.3	FS-11NO-0 (Single Slider), FS-12NO-0 (Double Slider)	66
6.4	FS-11WM-100 (Single Slider), FS-12WM-100 (Double Slider)	67
6.5	FS-11WM-200 (Single Slider), FS-12WM-200 (Double Slider)	68
6.6	FS-11WO-0 (Single Slider), FS-12WO-0 (Double Slider)	69
6.7	FS-11LM-400 (Single Slider), FS-12LM-400 (Double Slider)	70
6.8	FS-11HM-400 (Single Slider), FS-12HM-400 (Double Slider)	71
6.9	FS-11LO-0 (Single Slider), FS-12LO-0 (Double Slider)	72
7.	Life	73
8.	Warranty	74
8.1	Warranty Period	74
8.2	Scope of the Warranty	74
8.3	Honoring the Warranty	74
8.4	Limited Liability	75
8.5	Conditions of Conformance with Applicable Standards/Regulations, Etc., and Applications	75
8.6	Other Items Excluded from Warranty	75
	Change History	76

Safety Guide

“Safety Guide” has been written to use the machine safely and so prevent personal injury or property damage beforehand. Make sure to read it before the operation of this product.

Safety Precautions for Our Products

The common safety precautions for the use of any of our robots in each operation.

No.	Operation Description	Description
1	Model Selection	<ul style="list-style-type: none"> ● This product has not been planned and designed for the application where high level of safety is required, so the guarantee of the protection of human life is impossible. Accordingly, do not use it in any of the following applications. <ol style="list-style-type: none"> 1) Medical equipment used to maintain, control or otherwise affect human life or physical health. 2) Mechanisms and machinery designed for the purpose of moving or transporting people (For vehicle, railway facility or air navigation facility) 3) Important safety parts of machinery (Safety device, etc.) ● Do not use the product outside the specifications. Failure to do so may considerably shorten the life of the product. ● Do not use it in any of the following environments. <ol style="list-style-type: none"> 1) Location where there is any inflammable gas, inflammable object or explosive 2) Place with potential exposure to radiation 3) Location with the ambient temperature or relative humidity exceeding the specification range 4) Location where radiant heat is added from direct sunlight or other large heat source 5) Location where condensation occurs due to abrupt temperature changes 6) Location where there is any corrosive gas (sulfuric acid or hydrochloric acid) 7) Location exposed to significant amount of dust, salt or iron powder 8) Location subject to direct vibration or impact ● For an actuator used in vertical orientation, select a model which is equipped with a brake. If selecting a model with no brake, the moving part may drop when the power is turned OFF and may cause an accident such as an injury or damage on the work piece.

No.	Operation Description	Description
2	Transportation	<ul style="list-style-type: none"> ● When carrying a heavy object, do the work with two or more persons or utilize equipment such as crane. ● When the work is carried out with 2 or more persons, make it clear who is to be the leader and who to be the follower(s) and communicate well with each other to ensure the safety of the workers. ● When in transportation, consider well about the positions to hold, weight and weight balance and pay special attention to the carried object so it would not get hit or dropped. ● Transport it using an appropriate transportation measure. The actuators available for transportation with a crane have eyebolts attached or there are tapped holes to attach bolts. Follow the instructions in the operation manual for each model. ● Do not step or sit on the package. ● Do not put any heavy thing that can deform the package, on it. ● When using a crane capable of 1t or more of weight, have an operator who has qualifications for crane operation and sling work. ● When using a crane or equivalent equipments, make sure not to hang a load that weighs more than the equipment's capability limit. ● Use a hook that is suitable for the load. Consider the safety factor of the hook in such factors as shear strength. ● Do not get on the load that is hung on a crane. ● Do not leave a load hung up with a crane. ● Do not stand under the load that is hung up with a crane.
3	Storage and Preservation	<ul style="list-style-type: none"> ● The storage and preservation environment conforms to the installation environment. However, especially give consideration to the prevention of condensation. ● Store the products with a consideration not to fall them over or drop due to an act of God such as earthquake.
4	Installation and Start	<p>(1) Installation of Robot Main Body and Controller, etc.</p> <ul style="list-style-type: none"> ● Make sure to securely hold and fix the product (including the work part). A fall, drop or abnormal motion of the product may cause a damage or injury. Also, be equipped for a fall-over or drop due to an act of God such as earthquake. ● Do not get on or put anything on the product. Failure to do so may cause an accidental fall, injury or damage to the product due to a drop of anything, malfunction of the product, performance degradation, or shortening of its life. ● When using the product in any of the places specified below, provide a sufficient shield. <ol style="list-style-type: none"> 1) Location where electric noise is generated 2) Location where high electrical or magnetic field is present 3) Location with the mains or power lines passing nearby 4) Location where the product may come in contact with water, oil or chemical droplets

No.	Operation Description	Description
4	Installation and Start	<p>(2) Cable Wiring</p> <ul style="list-style-type: none"> ● Use our company's genuine cables for connecting between the actuator and controller, and for the teaching tool. ● Do not scratch on the cable. Do not bend it forcibly. Do not pull it. Do not coil it around. Do not insert it. Do not put any heavy thing on it. Failure to do so may cause a fire, electric shock or malfunction due to leakage or continuity error. ● Perform the wiring for the product, after turning OFF the power to the unit, so that there is no wiring error. ● When the direct current power (+24V) is connected, take the great care of the directions of positive and negative poles. If the connection direction is not correct, it might cause a fire, product breakdown or malfunction. ● Connect the cable connector securely so that there is no disconnection or looseness. Failure to do so may cause a fire, electric shock or malfunction of the product. ● Never cut and/or reconnect the cables supplied with the product for the purpose of extending or shortening the cable length. Failure to do so may cause the product to malfunction or cause fire. <p>(3) Grounding</p> <ul style="list-style-type: none"> ● The grounding operation should be performed to prevent an electric shock or electrostatic charge, enhance the noise-resistance ability and control the unnecessary electromagnetic radiation. ● For the ground terminal on the AC power cable of the controller and the grounding plate in the control panel, make sure to use a twisted pair cable with wire thickness 0.5mm^2 (AWG20 or equivalent) or more for grounding work. For security grounding, it is necessary to select an appropriate wire thickness suitable for the load. Perform wiring that satisfies the specifications (electrical equipment technical standards). ● Perform Class D Grounding (former Class 3 Grounding with ground resistance 100Ω or below).



No.	Operation Description	Description
4	Installation and Start	<p>(4) Safety Measures</p> <ul style="list-style-type: none">● When the work is carried out with 2 or more persons, make it clear who is to be the leader and who to be the follower(s) and communicate well with each other to ensure the safety of the workers.● When the product is under operation or in the ready mode, take the safety measures (such as the installation of safety and protection fence) so that nobody can enter the area within the robot's movable range. When the robot under operation is touched, it may result in death or serious injury.● Make sure to install the emergency stop circuit so that the unit can be stopped immediately in an emergency during the unit operation.● Take the safety measure not to start up the unit only with the power turning ON. Failure to do so may start up the machine suddenly and cause an injury or damage to the product.● Take the safety measure not to start up the machine only with the emergency stop cancellation or recovery after the power failure. Failure to do so may result in an electric shock or injury due to unexpected power input.● When the installation or adjustment operation is to be performed, give clear warnings such as "Under Operation; Do not turn ON the power!" etc. Sudden power input may cause an electric shock or injury.● Take the measure so that the work part is not dropped in power failure or emergency stop.● Wear protection gloves, goggle or safety shoes, as necessary, to secure safety.● Do not insert a finger or object in the openings in the product. Failure to do so may cause an injury, electric shock, damage to the product or fire.● When releasing the brake on a vertically oriented actuator, exercise precaution not to pinch your hand or damage the work parts with the actuator dropped by gravity.
5	Teaching	<ul style="list-style-type: none">● When the work is carried out with 2 or more persons, make it clear who is to be the leader and who to be the follower(s) and communicate well with each other to ensure the safety of the workers.● Perform the teaching operation from outside the safety protection fence, if possible. In the case that the operation is to be performed unavoidably inside the safety protection fence, prepare the "Stipulations for the Operation" and make sure that all the workers acknowledge and understand them well.● When the operation is to be performed inside the safety protection fence, the worker should have an emergency stop switch at hand with him so that the unit can be stopped any time in an emergency.● When the operation is to be performed inside the safety protection fence, in addition to the workers, arrange a watchman so that the machine can be stopped any time in an emergency. Also, keep watch on the operation so that any third person can not operate the switches carelessly.● Place a sign "Under Operation" at the position easy to see.● When releasing the brake on a vertically oriented actuator, exercise precaution not to pinch your hand or damage the work parts with the actuator dropped by gravity. <p>* Safety protection Fence : In the case that there is no safety protection fence, the movable range should be indicated.</p>







No.	Operation Description	Description
6	Trial Operation	<ul style="list-style-type: none">• When the work is carried out with 2 or more persons, make it clear who is to be the leader and who to be the follower(s) and communicate well with each other to ensure the safety of the workers.• After the teaching or programming operation, perform the check operation one step by one step and then shift to the automatic operation.• When the check operation is to be performed inside the safety protection fence, perform the check operation using the previously specified work procedure like the teaching operation.• Make sure to perform the programmed operation check at the safety speed. Failure to do so may result in an accident due to unexpected motion caused by a program error, etc.• Do not touch the terminal block or any of the various setting switches in the power ON mode. Failure to do so may result in an electric shock or malfunction.
7	Automatic Operation	<ul style="list-style-type: none">• Check before starting the automatic operation or rebooting after operation stop that there is nobody in the safety protection fence.• Before starting automatic operation, make sure that all peripheral equipment is in an automatic-operation-ready state and there is no alarm indication.• Make sure to operate automatic operation start from outside of the safety protection fence.• In the case that there is any abnormal heating, smoke, offensive smell, or abnormal noise in the product, immediately stop the machine and turn OFF the power switch. Failure to do so may result in a fire or damage to the product.• When a power failure occurs, turn OFF the power switch. Failure to do so may cause an injury or damage to the product, due to a sudden motion of the product in the recovery operation from the power failure.

No.	Operation Description	Description
8	Maintenance and Inspection	<ul style="list-style-type: none"> ● When the work is carried out with 2 or more persons, make it clear who is to be the leader and who to be the follower(s) and communicate well with each other to ensure the safety of the workers. ● Perform the work out of the safety protection fence, if possible. In the case that the operation is to be performed unavoidably inside the safety protection fence, prepare the “Stipulations for the Operation” and make sure that all the workers acknowledge and understand them well. ● When the work is to be performed inside the safety protection fence, basically turn OFF the power switch. ● When the operation is to be performed inside the safety protection fence, the worker should have an emergency stop switch at hand with him so that the unit can be stopped any time in an emergency. ● When the operation is to be performed inside the safety protection fence, in addition to the workers, arrange a watchman so that the machine can be stopped any time in an emergency. Also, keep watch on the operation so that any third person can not operate the switches carelessly. ● Place a sign “Under Operation” at the position easy to see. ● For the grease for the guide or ball screw, use appropriate grease according to the Operation Manual for each model. ● Do not perform the dielectric strength test. Failure to do so may result in a damage to the product. ● When releasing the brake on a vertically oriented actuator, exercise precaution not to pinch your hand or damage the work parts with the actuator dropped by gravity. ● The slider or rod may get misaligned OFF the stop position if the servo is turned OFF. Be careful not to get injured or damaged due to an unnecessary operation. ● Pay attention not to lose the cover or untightened screws, and make sure to put the product back to the original condition after maintenance and inspection works. <p>Use in incomplete condition may cause damage to the product or an injury.</p> <p>* Safety protection Fence : In the case that there is no safety protection fence, the movable range should be indicated.</p>
9	Modification and Dismantle	<ul style="list-style-type: none"> ● Do not modify, disassemble, assemble or use of maintenance parts not specified based at your own discretion.
10	Disposal	<ul style="list-style-type: none"> ● When the product becomes no longer usable or necessary, dispose of it properly as an industrial waste. ● When removing the actuator for disposal, pay attention to drop of components when detaching screws. ● Do not put the product in a fire when disposing of it. The product may burst or generate toxic gases.
11	Other	<ul style="list-style-type: none"> ● Do not come close to the product or the harnesses if you are a person who requires a support of medical devices such as a pacemaker. Doing so may affect the performance of your medical device. ● See Overseas Specifications Compliance Manual to check whether complies if necessary. ● For the handling of actuators and controllers, follow the dedicated operation manual of each unit to ensure the safety.

Alert Indication

The safety precautions are divided into “Danger”, “Warning”, “Caution” and “Notice” according to the warning level, as follows, and described in the Operation Manual for each model.

Level	Degree of Danger and Damage	Symbol
Danger	This indicates an imminently hazardous situation which, if the product is not handled correctly, will result in death or serious injury.	 Danger
Warning	This indicates a potentially hazardous situation which, if the product is not handled correctly, could result in death or serious injury.	 Warning
Caution	This indicates a potentially hazardous situation which, if the product is not handled correctly, may result in minor injury or property damage.	 Caution
Notice	This indicates lower possibility for the injury, but should be kept to use this product properly.	 Notice



Caution in Handling

- 1. Do not have the settings of speed and acceleration/deceleration exceeding the rated values.**

An operation with speed and acceleration/deceleration beyond the allowable range may cause an abnormal noise, vibration, malfunction or shortened life.

When having an interpolating operation for combined axes, set the smallest value among the combined axes for each of speed and acceleration/deceleration settings.
- 2. Set the allowable load moment within the allowable range.**

Use the product with the applied load moment within the allowable range.

An operation with the load beyond the allowable load moment may cause an abnormal noise, vibration, malfunction or shortened life. If it is extreme, flaking may occur on the guide.
- 3. Set the overhang length within the allowable range.**

Have the overhang length of the load within the allowable range. The overhang length above the allowable range may cause vibration or abnormal noise.
- 4. Back and forth operation in a short distance may cause wear of grease.**

If the actuator is operated back and forth repeatedly over a distance of 30 mm or less, the oil film created by the grease may be broken.

It is recommended to have 5 rounds of back and forth operation in a distance more than 50mm after every 5,000 to 10,000 rounds of the short distance operation. Keep using the actuator with the grease worn out may cause malfunction. If it is extreme, flaking may occur on the guide.
- 5. Ensure use of the product in the specified conditions, environments and ranges.**

Operation out of the specified conditions could cause a drop in performance or malfunction of the product.

Names of the Parts

In this manual, the right and left sides of the actuator are expressed in the way it is placed horizontally as shown in the figure below, and is looked at from the motor side.

[FS]

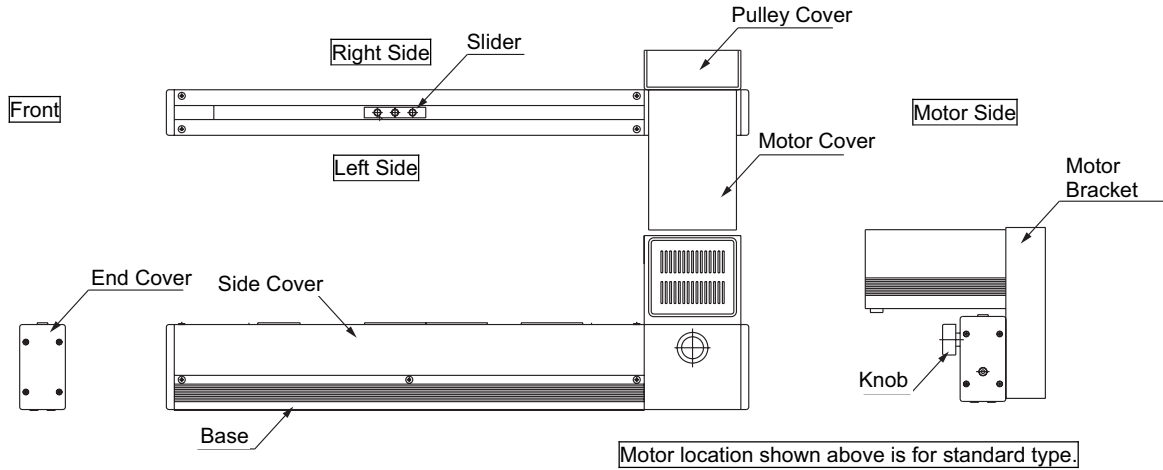

[FS Guide Module]

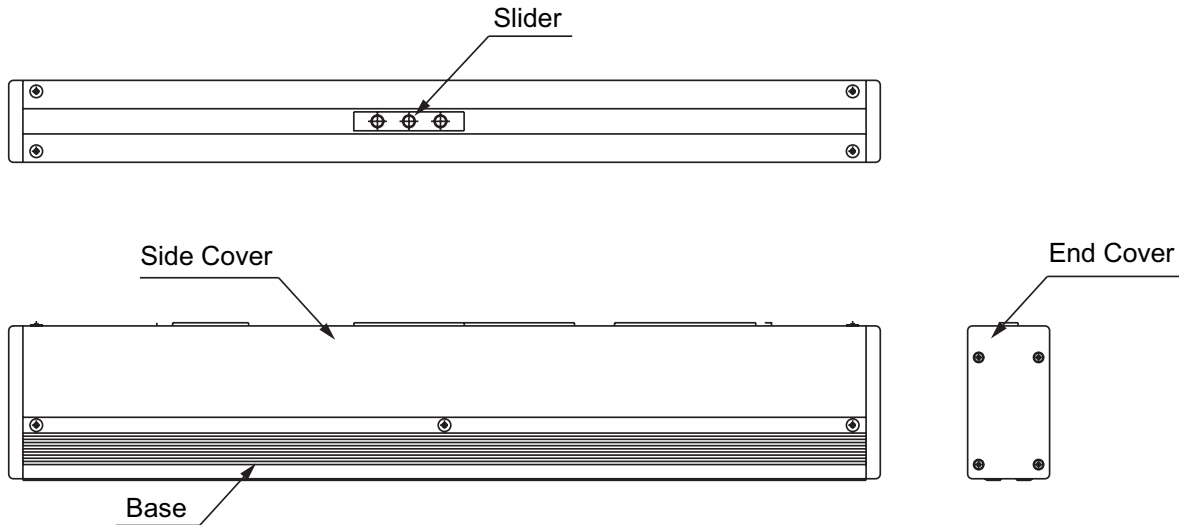



INTELLIGENT ACTUATOR

1. Specifications Check

1.1 Product Check

The standard configuration of this product is comprised of the following parts.
See the component list for the details of the enclosed components. If you find any broken or missing parts, contact your local IAI distributor.

1.1.1 Parts

No.	Part Name	Model	Quantity	Remarks
1	Main Body	Refer to "How to read the model plate" and "How to read the model No."	1	
Accessories				
2	Motor • Encoder Cables (Note 1)		1	
3	In-House Made Seals		1 set	
4	T-Nut		See the table below	Enclosed in FS
5	First Step Guide		1	
6	Operation Manual (DVD)		1	
7	Safety Guide		1	

Note 1 The motor • encoder cables differ between the standard model and robot cable.
[Refer to 6 Motor • Encoder Cables.]

Quantity of T-nuts enclosed in FS series

Stroke	NM, WM	LM
to 1000	5	10
to 1500	6	12
to 2000	7	14
to 2500	8	16
to 3000	9	18
to 3500	10	20
to 4000	11	22

1.1.2 Operation Manuals related to this product, which are contained in the DVD.

Shown below is a list of the operation manuals for the controllers related to this product which is recorded in Operation Manual (DVD).

(1) XSEL-J/K Controller

No.	Name	Manual No.
1	XSEL-J/K Controller Operation Manual	ME0116
2	PC software IA-101-X-MW/IA-101-X-USBMW Operation Manual	ME0154
3	Teaching pendant SEL-T/TD/TG Operation Manual	ME0183
4	Teaching pendant IA-T-X/XD Operation Manual	ME0160
5	DeviceNet Operation Manual	ME0124
6	CC-Link Operation Manual	ME0123
7	PROFIBUS-DP Operation Manual	ME0153
8	XSEL Ethernet Operation Manual	ME0140
9	Multi-Point I/O Board Operation Manual	ME0138
10	Multi-Point I/O Board Dedicated Terminal Board Operation Manual	ME0139

(2) XSEL-P/Q Controller

No.	Name	Manual No.
1	XSEL-P/Q Controller Operation Manual	ME0148
2	XSEL-P/Q/PX/QX RC Gateway Function Operation Manual	ME0188
3	PC software IA-101-X-MW/IA-101-X-USBMW Operation Manual	ME0154
4	Teaching pendant SEL-T/TD/TG Operation Manual	ME0183
5	Teaching pendant IA-T-X/XD Operation Manual	ME0160
6	DeviceNet Operation Manual	ME0124
7	CC-Link Operation Manual	ME0123
8	PROFIBUS-DP Operation Manual	ME0153

(3) SSEL Controller

No.	Name	Manual No.
1	SSEL Controller Operation Manual	ME0157
2	PC software IA-101-X-MW/IA-101-X-USBMW Operation Manual	ME0154
3	Teaching pendant SEL-T/TD/TG Operation Manual	ME0183
4	Teaching pendant IA-T-X/XD Operation Manual	ME0160
5	DeviceNet Operation Manual	ME0124
6	CC-Link Operation Manual	ME0123
7	PROFIBUS-DP Operation Manual	ME0153

(4) SCON Controller

No.	Name	Manual No.
1	SCON Controller Operation Manual	ME0161
2	SCON-CA Controller Operation Manual	ME0243
3	PC software RCM-101-MW/RCM-101-USB Operation Manual	ME0155
4	Teaching pendant CON-T/TG Operation Manual	ME0178
5	Touch panel teaching CON-PT/PD/PG Operation Manual	ME0227
6	Simple teaching pendant RCM-E Operation Manual	ME0174
7	Data setter RCM-P Operation Manual	ME0175
8	Touch Panel Display RCM-PM-01 Operation Manual	ME0182
9	DeviceNet Operation Manual	ME0124
10	CC-Link Operation Manual	ME0123
11	PROFIBUS-DP Operation Manual	ME0153

1.1.3 How to read the model plate

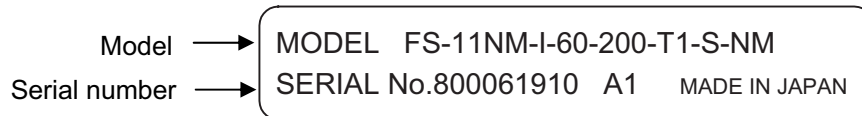

1.1.4 How to read the model No.

[FS]

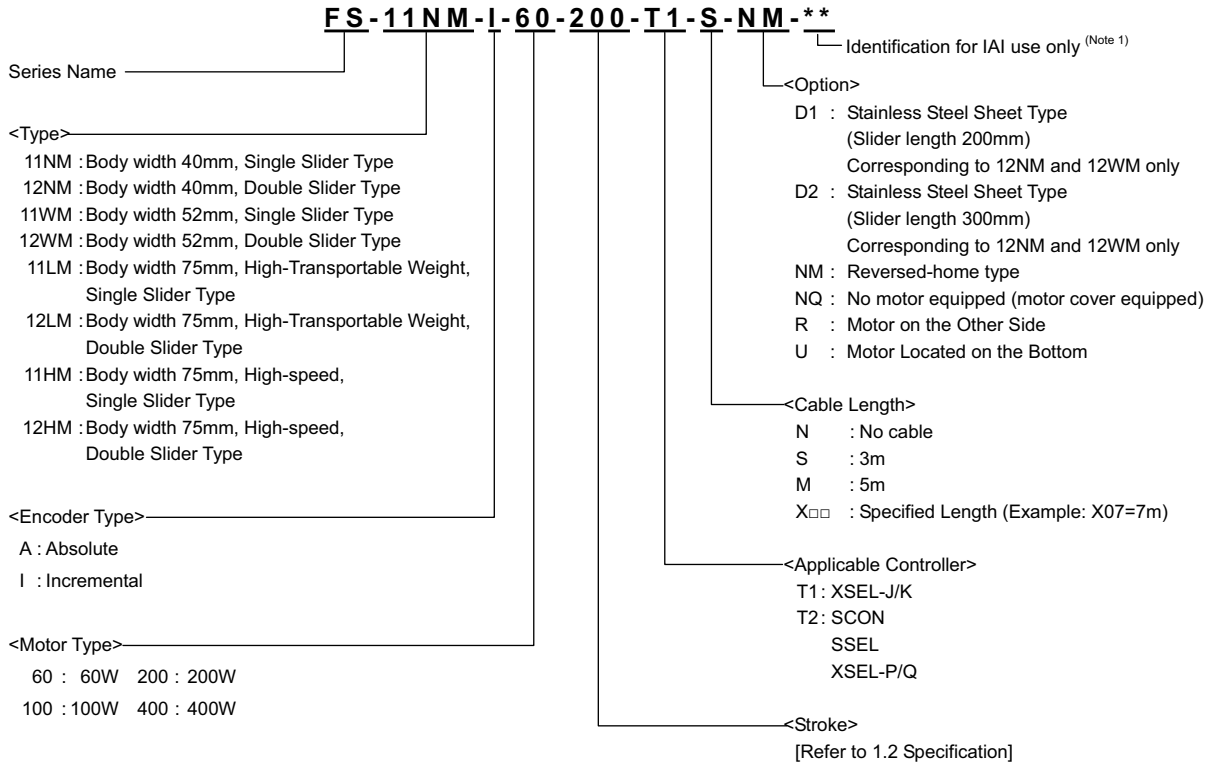

Note 1 Identification for IAI use only: It may be displayed for IAI use. It is not a code to show the model type.

[FS Guide Module]

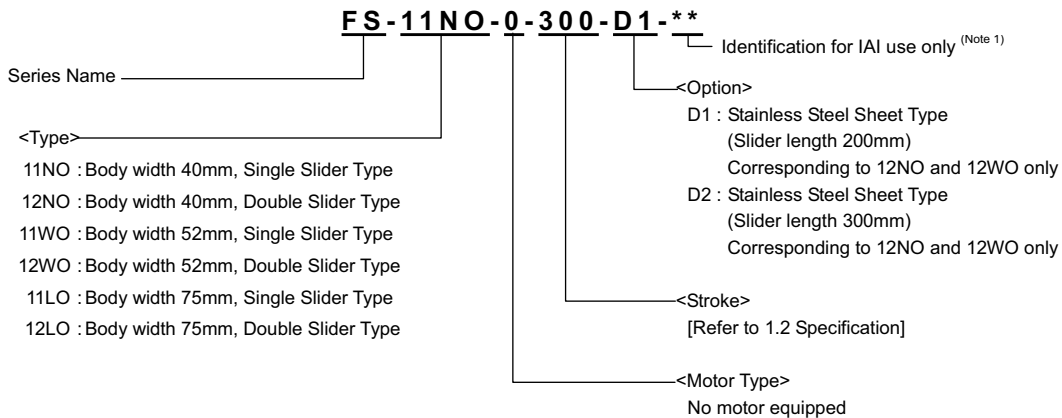

Note 1 Identification for IAI use only: It may be displayed for IAI use. It is not a code to show the model type.

1.2 Specification

[1] Max. speed

There is a limit in the maximum speed of the actuators.

Restriction on Speed (Unit: mm/s)

Type	Motor Type [W]	Stroke [mm]									
		200	300	400	500	600	700	800	900	1000	1100
SA	60	1 to 1750									
	100	1 to 1750									
MA	200	1 to 1750									

Type	Motor Type [W]	Stroke [mm]									
		1200	1300	1400	1500	1600	1700	1800	1900	2000	
SA	60	1 to 1750									
	100	1 to 1750									
MA	200	1 to 1750									

Type	Motor Type [W]	Stroke [mm]				
		2100	2200	2300	2400	2500
SA	60	-				
	100	-				
MA	200	1 to 1750				

[2] Maximum acceleration and Transportable Weight

When the transported weight is low, the acceleration/deceleration can be increased.

Type	Motor Type [W]	Acceleration/deceleration [G]	Transportable Weight [kg]	Rated Thrust [N]
SA	60	0.3	5	25.8
	100	0.3	10	43.0
MA	200	0.3	20	85.7

 Caution: Do not have the settings of acceleration/deceleration exceeding the rated values. It may cause vibration, malfunction or shortened life.



[3] Driving System and Position Detector

Type	Motor Type [W]	No. of Encoder Pulses	Drive System
SA	60	16384	Timing belt
	100		
MA	200		

[4] Positioning Accuracy

Item	Specification
Positioning Repeatability	$\pm 0.08\text{mm}$
Lost Motion	0.1mm or less

The values shown above are the accuracy at the delivery from the factory. It does not include the consideration of time-dependent change as it is used.



1.3 Option

1.3.1 Reversed-home type

The home is set on the side opposite the motor.
The model code is indicated with an NM.

1.4 Motor • Encoder Cables

1.4.1 Motor Cable (For XSEL-J/K/P/Q, SSEL and SCON) CB-X-MA□□□

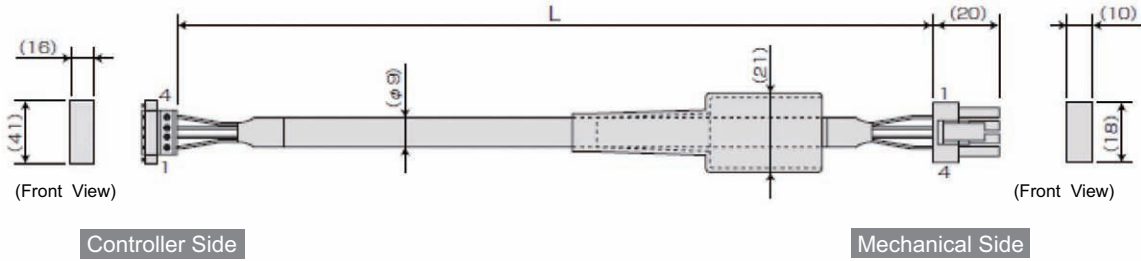

Wiring	Color	Signal	No.	No.	Signal	Color	Wiring
0.75sq	Green	PE	1	1	U	Red	0.75sq (Solderless)
	Red	U	2	2	V	White	
	White	V	3	3	W	Black	
	Black	W	4	4	PE	Green	

1.4.2 Encoder Cable (For XSEL-J/K) CB-X-PA□□□

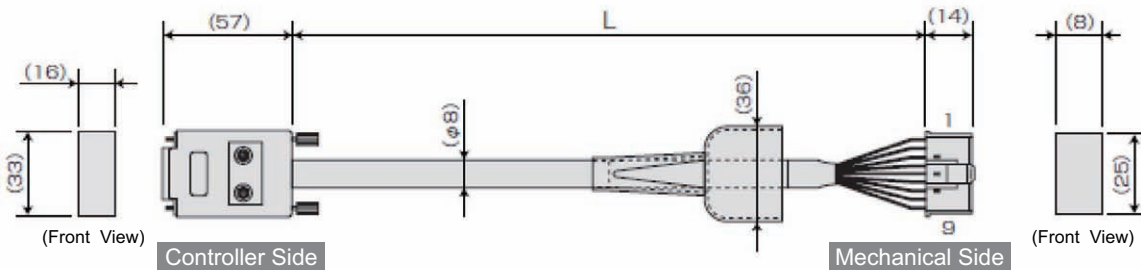

Wiring	Color	Signal	No.	No.	Signal	Color	Wiring
0.15sq (Solderless)	-	-	1	1	BAT+	Black	0.15sq (Solderless)
	-	-	2	2	BAT-	Yellow	
	-	-	3	3	SD	Blue	
	-	-	4	4	SD	Orange	
	Blue	SD	7	5	VCC	Green	
	Orange	SD	8	6	GND	Brown	
	Black	BAT+	9	7	FG	Drain	
	Yellow	BAT-	10	8	BK-	Gray	
	Green	VCC	11	9	BK+	Red	
	Brown	GND	12	-	-	-	
	Gray	BK-	13	-	-	-	
	Red	BK+	14	-	-	-	
	-	-	15	-	-	-	

The shield is clamped to the hood
Ground wire and braided shield wires

1.4.3 Limit Switch Cable (For XSEL-J/K) CB-X-LC□□□

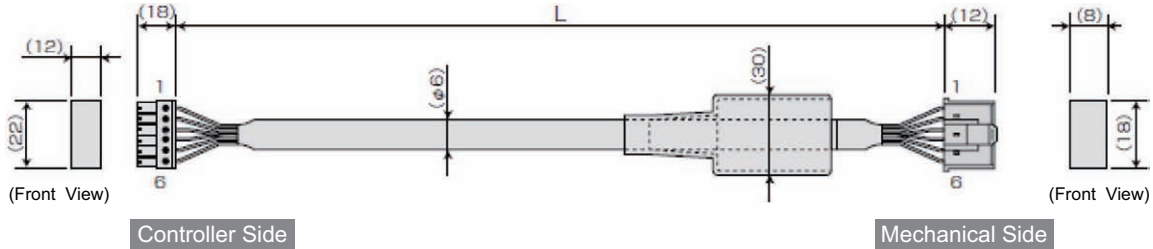

Wiring	Color	Signal	No.	No.	Signal	Color	Wiring
AWG24	Sky Blue	24VOUT	6	1	24VOUT	Sky Blue	AWG24 (Solderless)
	Pink	N	5	2	N	Pink	
	Light Green	LS	4	3	LS	Light Green	
	Orange	CREEP	3	4	CREEP	Orange	
	Gray	OT	2	5	OT	Gray	
	1B/Sky Blue	RSV	1	6	RSV	1B/Sky Blue	

Note) 1B indicates one black dot mark.

1.4.4 Encoder Cable (For XSEL-P/Q, SSEL, SCON and LS equipped type connection) CB-X1-PLA□□□

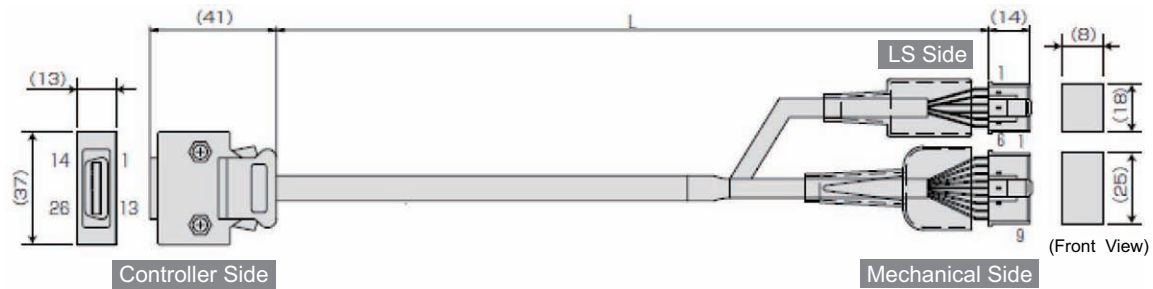

Wiring	Color	Signal	No.	No.	Signal	Color	Wiring
AWG26 (Soldered)	-	-	10	1	E24V	White/Blue	AWG26 (Solderless)
	-	-	11	2	0V	White/Yellow	
	White/Blue	E24V	12	3	LS	White/Red	
	White/Yellow	0V	13	4	CREEP	White/Black	
	White/Red	LS	26	5	OT	White/Purple	
	White/Black	CREEP	25	6	RSV	White/Gray	
	White/Purple	OT	24	-	-	-	9
	White/Gray	RSV	23	-	-	-	18
	-	-	-	-	-	-	19
	-	A+	1	-	-	-	1
	-	A-	2	-	-	-	2
	-	B+	3	-	-	-	3
	-	B-	4	-	-	-	4
	-	Z+	5	-	-	-	5
	-	Z-	6	-	-	-	6
	Orange	SRD+	7	-	-	-	7
	Green	SRD-	8	-	-	-	8
	Purple	BAT+	14	-	-	-	3
	Gray	BAT-	15	-	-	-	4
	Red	VCC	16	-	-	-	5
	Black	GND	17	-	-	-	6
	Blue	BKR-	20	-	-	-	7
Yellow	BKR+	21	-	-	-	8	
-	-	22	-	-	-	9	

The shield is clamped to the hood

Ground wire and braided shield wires

(White/blue in cable color indicates the colors of line/insulator.)



2. Installation

2.1 Transportation

[1] Handling of the Robot

Pay attention to the following when carrying an actuator by itself.

(1) Handling of the Packed Product

Unless otherwise specified, the single axes at the delivery are packaged individually. Please concern the handling of the unit so you would not hit or drop it while carrying.

- An operator should never attempt to carry a heavy package on their own.
- If the shipping box is to be left standing, it should be in a horizontal position.
- Do not step or sit on the package.
- Do not put any heavy thing that can deform the package, on it.

(2) Handling after Unpackaged

Do not attempt to hold the motor unit or cable when carrying the actuator, or pull the cables to move the unit. Do not carry the actuator by holding the cable, or do not move it by pulling the cable.

Make sure to hold the base area when handling the unpackaged actuator.

[2] Handling of Multi-Axes Type

Pay attention to the following when carrying the robot with the axes being attached.

(1) Handling of the Packed Product

If an order for the product was made with the axes attached, we would build the product in our factory, conduct the delivery inspection, affix on a wooden pallet and cover with the frames to deliver the product.

If the actuator to be attached is a slider type, the slider is fixed in the package so it would not accidentally move. Also for the actuator of the combined unit, the end is fixed so it would not widely shake by the external vibration.

- The package is not applied with any special treatment that enables it to resist an impact caused by a drop or crash. Handle it with care. Also, please note that the frame would not endure load on the top. Do not attempt to put load on it.
- When suspending the package using belts, pass the belts from underneath the reinforcement frames at the bottom of the base. When lifting with a forklift, also place the forks underneath the base.
- Handle with care not to apply shock when putting it down.



(2) Handling after Unpackaged

After unpackaged, handle the product that axes were attached in IAI factory following the instructions below:

- Fix the sliders during transportation so they would not move accidentally.
- Appropriately fix the end of the actuators if it is overhanging so it would not widely shake with external vibration. If the actuator assembly is transported without the ends being secured, do not apply an impact of 0.3G or more.
- In such cases as hanging the peripherals including the actuators with a belt, do not attempt to attach the belt directly to the actuators and avoid the belt being touch the actuators.
- Apply appropriate shock-proof methods to the belt and set it so the base part receives the load.
- For Y-axis, support the end with another belt to maintain the stable horizontal orientation. At the same time, pay attention not to apply load to the screw cover.
- Do not attempt to apply load to the brackets, covers or connector box mounted on the main body.

Also, avoid the cables being pinched or caused an excessive deformation.

[3] Handling of the Robot Mounted on Mechanical Equipment (System)

When peripheral devices were attached by the customer and the unit is to be carried, also follow the instructions described in [5.2.2 handling in unpackaged condition] for appropriate handling.



2.2 Installation and Storage • Preservation Environment

[1] Installation Environment

Do not use this product in the following environments.

It is generally the environment where a worker can work without any protection gear.

Also make sure to keep enough work space necessary for maintenance.

- Location exposed to radiant heat from a huge heat source such as the heat treatment
- Location where the surrounding air temperature exceeds the range of 0 to 40°C
- Location where condensation occurs due to abrupt temperature changes
- Location where relative humidity exceeds 85%RH
- Location exposed to direct sunlight
- Location exposed to corrosive gases or combustible gases
- Location exposed to significant amount of dust, salt or iron powder (Outside of an ordinary assembly plant)
- Location where water, oil (includes oil mist and cutting fluid) or a chemical is splashed
- Location where the product main body receives vibration or hit impact

When using the product in any of the locations specified below, provide a sufficient shield.

- Place subject to electrostatic noise
- Location where exposed to the influence of strong electric or magnetic field
- Location where exposed to the influence of ultraviolet or radiant rays

[2] Storage • Preservation Environment

- The storage and preservation environment should comply with the same standards as those for the installation environment. In particular, when the machine is to be stored for a long time, pay close attention to environmental conditions so that no dew condensation forms.
- Unless specially specified, moisture absorbency protection is not included in the package when the machine is delivered. In the case that the machine is to be stored and preserved in an environment where dew condensation is anticipated, take the condensation preventive measures from outside of the entire package, or directly after opening the package.
- For storage and preservation temperature, the machine withstands temperatures up to 60°C for a short time, but in the case of the storage and preservation period of 1 month or more, control the temperature to 50°C or less.
- Storage and preservation should be performed in the horizontal condition. In the case it is stored in the packaged condition, follow the posture instruction if any displayed on the package.

2.3 How to Install

Shown below is how to install the actuators to the machinery equipment.

2.3.1 Posture of Actuator Installation

Shown below are the basic concepts for the product attachment.

Pay special attention when deciding how to install the product (Except with custom-order models).

○: Available △: Precautions observing strictly ×: Not available

Horizontal Installation	Vertical Installation	Sideway Installation	Ceiling mount Installation	
			Stainless Steel Sheet Type If is not D1/D2	Stainless Steel Sheet Type In the case of D1/D2
○	×	×	○	×

Installation posture

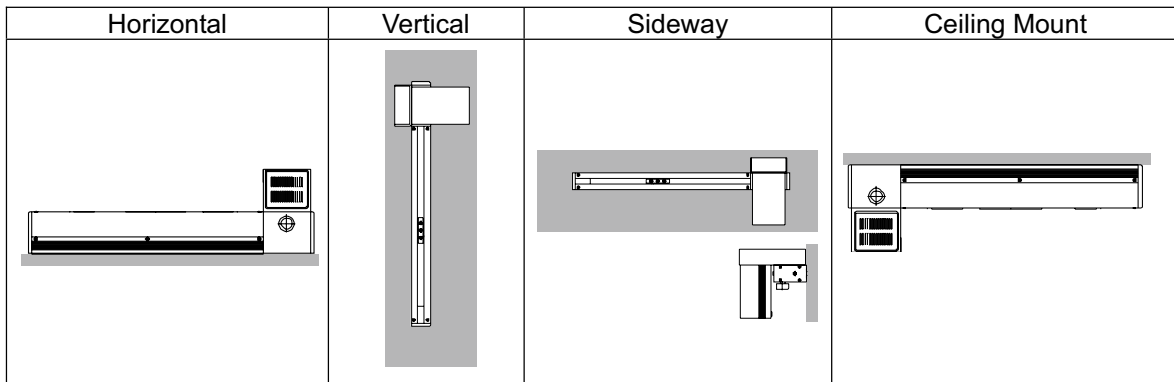

2.3.2 Installation

[1] Installation of Main Unit

- There is a T-groove on the back of the base. When installing the body, utilize this T-groove and hold the body with the T-nut enclosed with the actuator.
- The base has to have a structure with sufficient rigidity to prevent oscillation.
- The surface where the actuator will be mounted should be a machined surface or that with an accuracy equivalent to it, and the flatness should be 0.05mm or below.

Ensure a room for maintenance work.

(1) Mounting Procedure

- The bolts for mounting the actuator should be of a dimension suitable for the mounting holes and slot.
- Use hexagonal bolts for the actuator mounting holes.
- We recommend high strength bolts of ISO-10.9 or higher.
- Make sure to have the effective length of screw engagement described below or more for the tightening of a bolt and a female screw.
 - When female screw is on steel → thread length same as nominal diameter
 - When female screw is on aluminum → thread length 2 times longer than nominal diameter
- When attaching the base to a mounting table, use washers made for high strength bolt if the bolts is M8 or larger or if the bearing surface is made of aluminum. A washer is not necessary for M6 or smaller bolts. Do not use a common spring washer.
- The recommended screw torque is given below.

Screw Nominal Diameter	Tightening Torque
M6	7N•m [0.7kgf•m]
M8	26N•m [2.6kgf•m]

- Use the T-nuts provided by IAI. (Please see drawing below).
- If you require more than the number included, additional nuts are available for purchase.
- When mounting the actuator, select a bolt length so that the tip of the bolt does not touch the bottom of the T-slot.
- If you are purchasing brackets with the actuator, please use the bolts, nuts and washers that come with brackets.

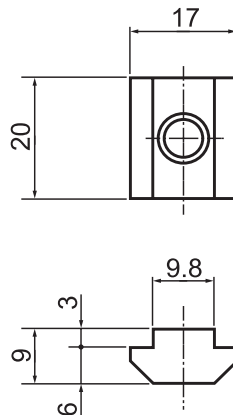

Shape of T-nut

[2] Load Attachment

- There are M8 tapped holes prepared on the slider. Fix the work piece to be carried.
- The way to affix follows the installation of the main unit.
- There is a restriction on the moment and overhang load length when attaching a load to the slider.

Type			Allowable Load Moment [N·m]	Overhang Load Length [L]
FS-11NM FS-11NO	Fig. 1)	Single Slider	Ma: 2.9 (0.3) Mb: 2.9 (0.3) Mc: 4.5 (0.46)	Ma direction: 200 or less Mb, Mc direction: 200 or less
FS-12NM FS-12NO	Fig. 2)	Double Slider (when sliders are joined together)	Ma: 20.5 (2.1) Mb: 18.6 (1.9) Mc: 9.1 (0.93)	Ma direction: 500 or less Mb, Mc direction: 500 or less
FS-11WM FS-11WO	Fig. 1)	Single Slider	Ma: 4.4 (0.45) Mb: 3.9 (0.4) Mc: 5.8 (0.6)	Ma direction: 240 or less Mb, Mc direction: 240 or less
FS-12WM FS-12WO	Fig. 2)	Double Slider (when sliders are joined together)	Ma: 27.4 (2.8) Mb: 25.4 (2.6) Mc: 11.7 (1.2)	Ma direction: 600 or less Mb, Mc direction: 600 or less
FS-11LM FS-11LO FS-11HM	Fig. 1)	Single Slider	Ma: 8.8 (0.9) Mb: 7.8 (0.8) Mc: 12.7 (1.3)	Ma direction: 300 or less Mb, Mc direction: 300 or less
FS-12LM FS-12LO FS-12HM	Fig. 2)	Double Slider (when sliders are joined together)	Ma: 51.9 (5.3) Mb: 47.0 (4.8) Mc: 25.4 (2.6)	Ma direction: 750 or less Mb, Mc direction: 750 or less

Allowable dynamic moment directions

The allowable dynamic moment is the value assuming 20,000km. Use of the actuator above the moment specification could cause a drop of the life of the guide.

Moment Directions

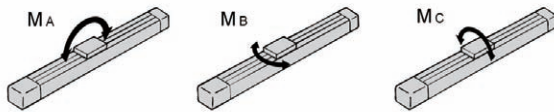

Overhang Load Length

Use of the actuator with an overhang above the allowable range for each model could cause vibration or delay in the operation time. Make sure to use the actuator in the allowable range.

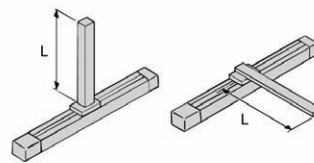

Single Slider (Fig. 1)

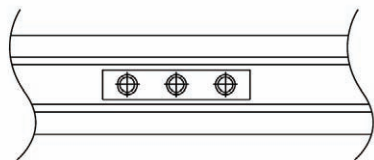

Double Slider (Fig. 2)

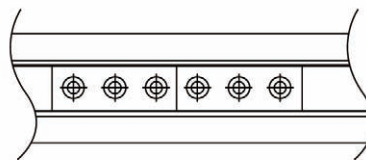



3. Connection to the Controller

For the controller, only the dedicated controller manufactured by our company can be used. Using other controllers may cause a problem such as burning the product, ignition or generating heat. Use the dedicated cable enclosed in the package when connecting the actuator and the controller.

In this section, describes how to lay out the wirings for the single axis use.

In the single axis use, unless otherwise specified, the actuator will be delivered with a single axis dedicated cable with 3m or 5m of its length enclosed in. Plug in the connector on the cable end directly to the controller.

- Although we use cable that is resistant to bending fatigue, it is not robot cable. Please avoid housing the cable in a wire duct with a small bending radius (we recommend R90 or larger).
- In an application where the cable cannot be anchored, try to place the cable where it will sag only under its own weight or use self-standing cable hose as large radius wire duct to limit the load on the cable.
- Do not cut the cable to lengthen, shorten, or reconnect it.

If you wish to alter the cable, please consult with IAI before doing so.

Warning: For wiring, please follow the warnings stated below. When constructing a system as the machinery equipment, pay attention to the wiring and connection of each cable so they are conducted properly. Not following them may cause not only a malfunction such as cable breakage or connection failure, or an operation error, but also electric shock or electric leakage, or may even cause a fire.

- Use dedicated cables of IAI indicated in this operation manual. Contact us if you wish to have a change to the specifications of the dedicated cables.
- Make sure to turn the power OFF in the process of power line or cable connection or disconnection.
- Do not attempt to cut a dedicated cable with connectors on both ends to extend, shorten or re-joint it.
- Hold the dedicated cable to avoid mechanical force being applied to the terminals and connectors.
- Use a cable pipe or duct to have an appropriate protection when there is a possibility of mechanical damage on a dedicated cable.
- In case a dedicated cable is to be used at a moving part, make sure to lay out the cable without applying any force to pull the connector or extreme bend on the cable. Do not attempt to use the cable with a bending radius below the allowable value.
- Make certain that the connectors are plugged properly. Insufficient connection may cause an operation error, thus it is extremely risky.
- Insufficient connection may cause an operation error, thus it is extremely risky.
- Pay attention to the cable layout so it would not hit peripherals during an operation. In case it does, have an appropriate protection such as a cable track.
- When a cable is used hanging on the ceiling, prevent an environment that the cable swings with acceleration or wind velocity.
- Make sure there is not too much friction inside the cable storage equipment.
- Do not apply radiated heat to power line or cables.
- Have a sufficient radius for bending to avoid stress being applied to one place.

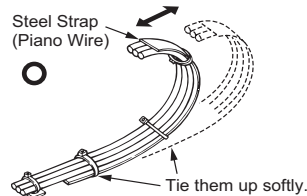
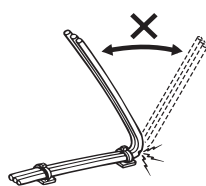

- Do not let the cable bend, kink or twist.

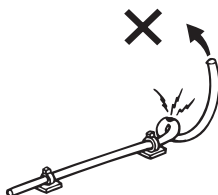

- Do not pull the cable with a strong force.

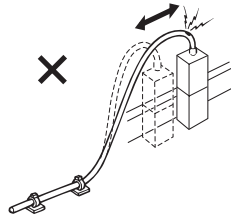

- Do not let the cable receive a turning force at a single point.

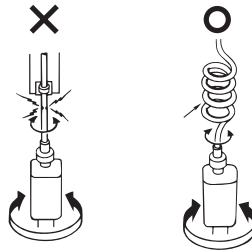

- Do not pinch, drop a heavy object onto or cut the cable.

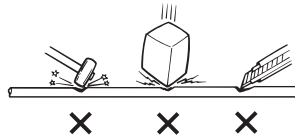

- When fixing the cable, provide a moderate slack and do not tension it too tight.

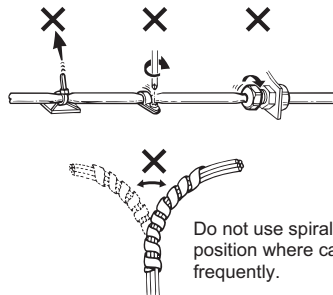

Do not use spiral tube in any position where cables are bent frequently.

- Separate the PIO line, communication line and power line from each other. Arrange so that such lines are independently routed in the duct.

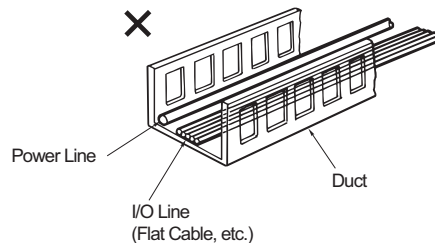

Follow the instructions below when using a cable track.

- If there is an indication to the cable for the space factor in a cable track, refer to the wiring instruction given by the supplier when storing the cable in the cable track.
- Avoid the cables to get twined or twisted in the cable track, and also to have the cables move freely and do not tie them up. (Avoid tension being applied when the cables are bent.) Do not pile up cables. It may cause faster abrasion of the sheaths or cable breakage.

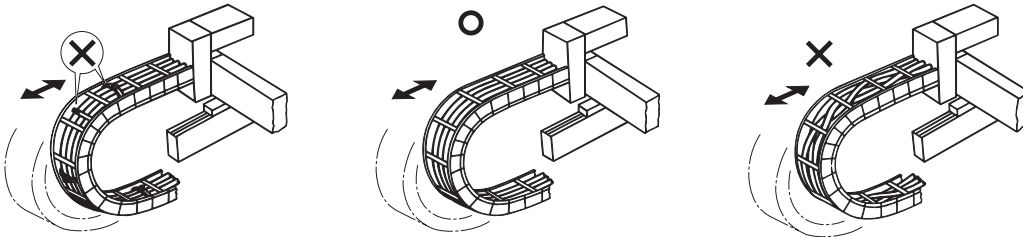

4. Setting the Home Position

[1] The Principle of the Homing Operation

The actuator performs homing in the following manner:

- 1) The moving direction is determined by the parameters set by the homing command.
- 2) It detects the mechanical end with the software in the home return operation.
- 3) The slider reverses direction when this end is reached and the place where the Z phase signal is detected becomes the reference point.
- 4) The slider travels further by an offset amount defined by the parameters and this position becomes home.

(* The number of motor revolutions after the actuator hits the stopper until the Z-phase signal is generated is already adjusted before the shipment.)

[2] Attaching Alignment Marks

- Use this mark by means of affixing to the product as the guide for the origin direction of the actuator, as occasion demands.

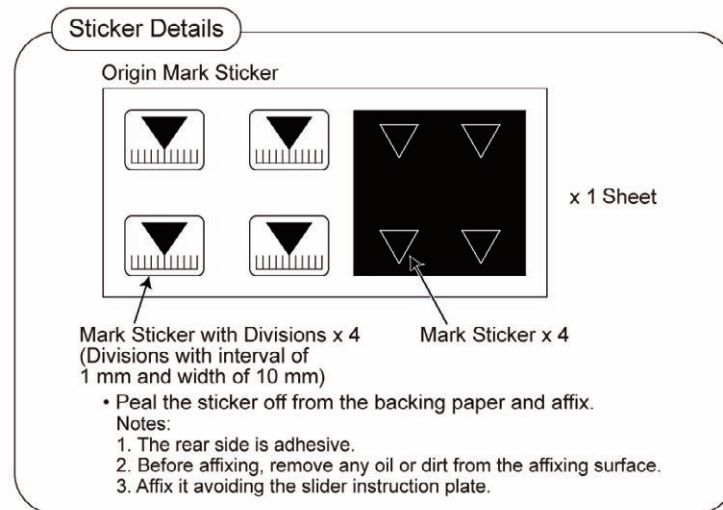

[Use Examples]

- 1) Affixing it as the guide for the homing direction of the actuator

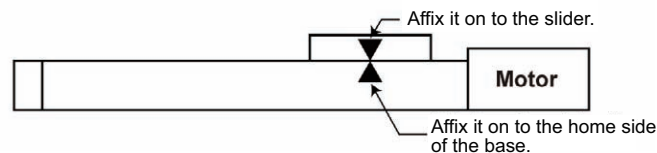

2) Affixing it as the guide of the slider positions after movement

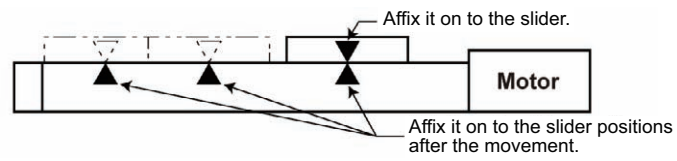

3) Affixing it as the guide for the deviation check

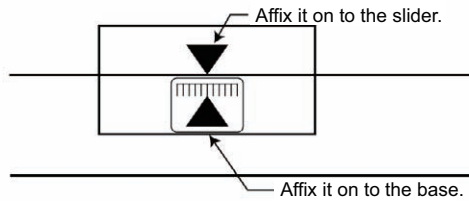

- Affix two stickers each onto the slider and base while they are stopped at their origin positions.

5. Maintenance Inspection

5.1 Inspection Items and Inspection Schedule

Have maintenance inspections following the intervals below.

The calculation is conducted under the condition that there are 8 working hours per day. Have inspections more frequently if the operation frequency is high for night and day continuous operation, etc.

	Visual Inspection	Internal Check	Grease supply **1
At startup inspection	○		
1 month after start of operation	○		
6 months after start of operation	○	○	
1 year after start of operation	○	○	○
Every 6 months thereafter	○		
Every 1 year since	○	○	○

*1 If the actuator is operated back and forth repeatedly over a distance of 30 mm or less, the oil film created by the grease may be broken. It is recommended to have 5 cycles of back and forth operation in a distance more than 50mm after every 5,000 to 10,000 rounds of the short distance operation. A layer of the grease will recover.

5.2 Visual inspection

For the visual inspection, check the appearance following items.

Main Body	Looseness of attachment screws
Cables	Scratches, proper connection of connectors
Overall	Noise, vibration

5.3 Cleaning

- Please clean the external body on a regular basis.
- When cleaning, wipe with a soft cloth to remove dust and dirt.
- The base oil of the grease may come out on the surface of the actuator in some cases. Wipe it away with soft cloth.
- There is a risk of dust getting in from a clearance. Do not blow compressed air strongly to the body.
- Do not apply petroleum solvent since it may damage the resin or painted surfaces.
- When extremely dirty, wipe it off firmly with cloth that a neutral detergent or alcohol is applied on.



5.4 Inside Visual Inspection

Turn the power OFF, remove the side cover and do a visual check of the inside.

Confirm the inside condition with visual check.

Check to see if there is any dust or foreign objects inside the unit, and check the lubrication and condition of the timing belt.

- Even if the grease is a brown color, the lubrication is fine as long as the travelling surface appears to be wet.
- Check to see if there is any damage to the timing belt such as cracks in the teeth or in the section behind the teeth.
(Note) The timing belt may generate a black powder. This is due to friction and is not unusual.
- The side cover can be removed with a hexagonal wrench.

If the grease is mixed with dust and dirty or has no shiny appearance, or if the grease has lost its efficacy due to prolonged use, clean the applicable area and then replenish the grease.

After you finish inspection, tighten the mounting screws for side cover. The screw torque should be for a cross-recessed head machine screw.

5.5 Internal Cleanup

- When cleaning, wipe with a soft cloth to remove dust and dirt.
- There is a risk of dust getting in from a clearance. Do not blow compressed air strongly to the body.
- Do not use oil type solvent, neutral detergent or alcohol.

5.6 Grease Supply

[1] Applied Grease

The following grease is applied when the product is shipped out.

Idemitsu Kosan Co., Ltd.	Daphne Eponex Grease No.2
--------------------------	---------------------------

Apart from above, there are equivalent sorts of grease sold in the market. For details contact a grease supplier, provide the grease name shown above and ask them to select an equivalent. Listed below are some equivalents for an example.

Showa Shell Sekiyu K. K.	Albania Grease S2
Mobil Oil	Unirex N2

 **Warning:** Do not attempt to apply fluorine grease. When mixed with lithium grease, not only decrease the grease characteristics, but also may damage the actuator.

[2] How to apply grease

- 1) Remove the side cover.
- 2) With a grease gun, squirt grease into the grease nipple in the LM block to which the slider is attached.
Insert enough grease so that some of it leaks out of the other side of the LM block.
- 3) Repeat this procedure for the other grease nipples on the LM block.

Model	Grease supply volume (reference)
NM	1cc
WM	0.5cc
LM	2cc to 2.5cc
HM	2cc to 2.5cc

Make sure to use a grease gun that is applicable for the grease nipple inlet diameter shown below.

Nipple inlet diameter [mm]
φ 6

Model	Recommended grease gun	Nozzle	Supplier
NM	MG70	N model	THK
WM	MG70	H model	THK
LM			
HM			

- 4) Move the slider back and forth several times by hand.
- 5) After this, wipe away the excess grease from the LM block.
- 6) Replace the side cover.

 **Caution:** In case the grease got into your eye, immediately go see the doctor to get appropriate care. After finishing the grease supply work, wash your hands carefully with water and soap to rinse the grease off.

5.7 Driving Belt Replacement

[Items required for the Replacement]

- Replacement Driving Belt
- Packing Tape
- 8mm Spanner Wrench
- Hexagon Wrench Set
- Push-Pull Gauge and Square
- Personal Computer or Teaching Pendant
- Tension Gauge (Tension of 10kgf or more available)
- Strong Thread (or Long Harness Belt)

[Replacement Operation Outline]

- 1) Loosen the tension adjusting bolt and replace the belt. Then, fasten the adjusting bolt until the specified tension value is reached.
- 2) Perform the homing operation.
Loosen the deceleration belt, affix the slider at the point of 9mm from the mechanical end on the home side, affix the motor shaft at the alignment mark, and then adjust the deceleration belt to the specified tension.
- 3) Perform a home-return operation with using PC or a teaching pendant to check the amount of misalignment from the original home position. In case there is misalignment, adjust the position with Home-Return Offset for E-Con, P-Driver and SCON Controllers. For SSEL Controllers and X-SEL Controllers, use Home Preset for adjustment.

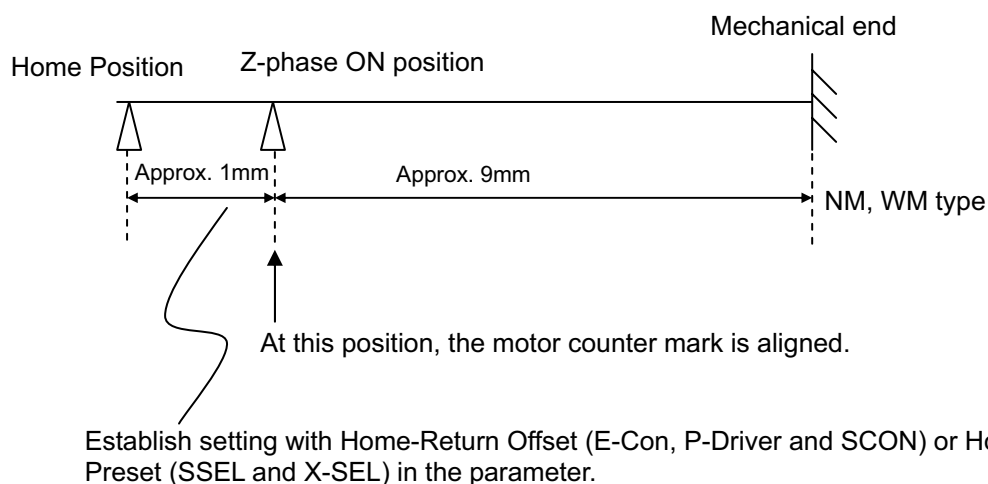

[Procedure]

- 1) Detach the pulley cover and check the direction of motor shaft rotation when moving the slider from the home position side to the mechanical end side. (the rotational direction differs depending on the motor attachment position, thus checking is necessary.)

Detach the pulley cover.
(Use a hexagon wrench with the distance to the opposite side of 1.5mm.)



Confirm the motor shaft rotating direction.

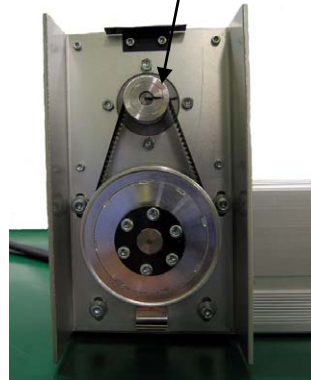

- 2) Move the slider to a point where Z-phase to be the home turns ON.
The point should be 9mm away from the mechanical end for both home standard type and home reversed type.
Put marks on the mechanical end and the point of Z-phase.

Put a mark on the mechanical end
where slider was pushed against.

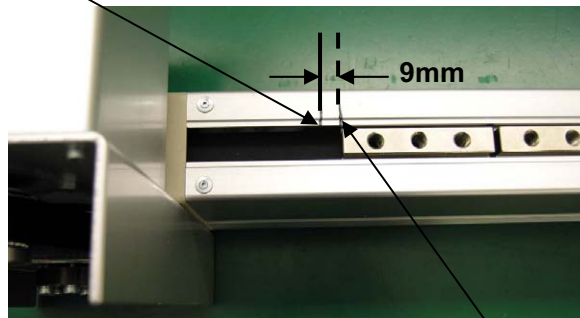

Move the slider back away for 9mm from the
mechanical end.
Put another mark on this Z-phase point.

- 3) Detach the side covers on both sides.
Remove the screws on the top and side.
(Use a hexagon wrench with the distance to the opposite side of 1.5mm.)



- 4) Detach the end cover on the side opposite the motor.
(Use a hexagon wrench with the distance to the opposite side of 2.5mm.)

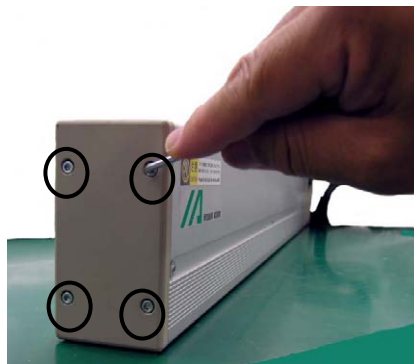

- 5) Loosen the locknut to make the tension adjustment bolts free.
(Use a spanner wrench of 8mm.)

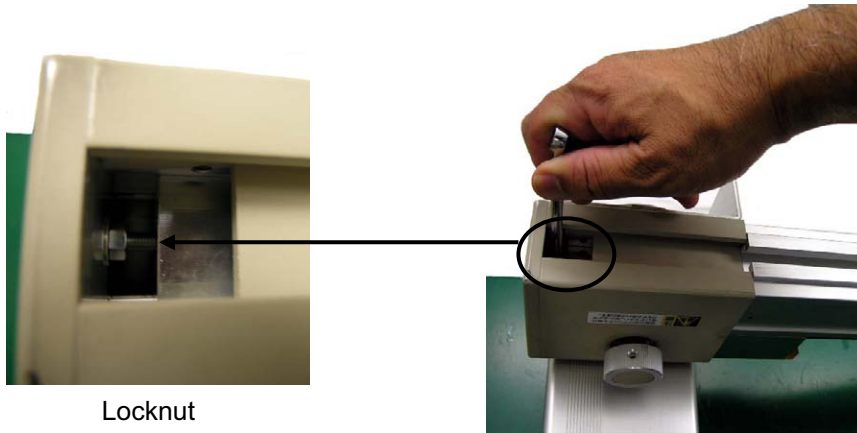

- 6) Loosen the tension adjustment bolt on the motor side.
(Use a hexagon wrench with the distance to the opposite side of 4mm.)

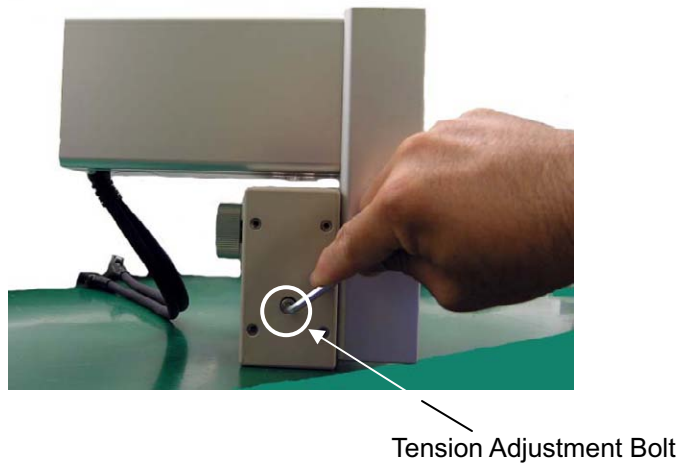

- 7) Detach the end cover on the motor side.
(Use a hexagon wrench with the distance to the opposite side of 2.5mm.)

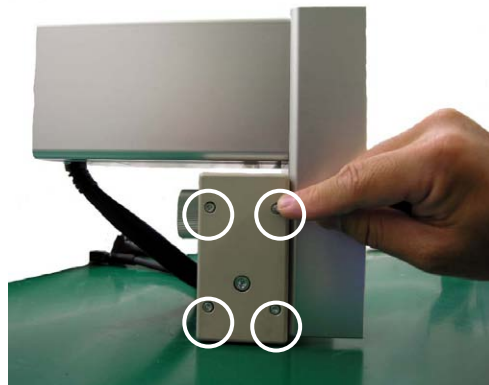

- 8) Loosen the pulley fixing screws on the driving belt side.
(Use a hexagon wrench with the distance to the opposite side of 4mm.)



- 9) Remove the deceleration belt to make the pulley free.

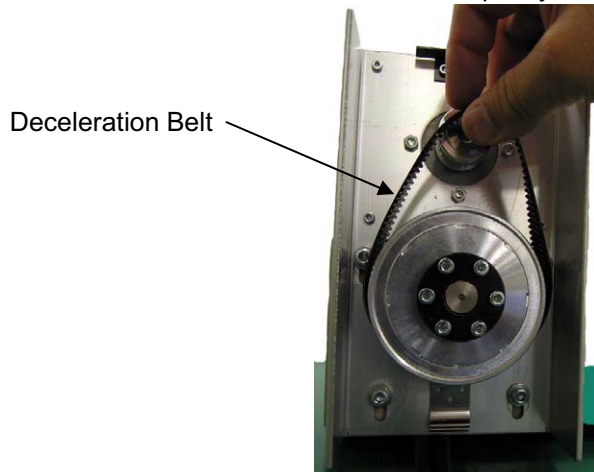

- 10) Detach the driving belt retainer plate.
(Use M4-sized hex wrench for NM. Use M5-sized hex wrench for WM.)

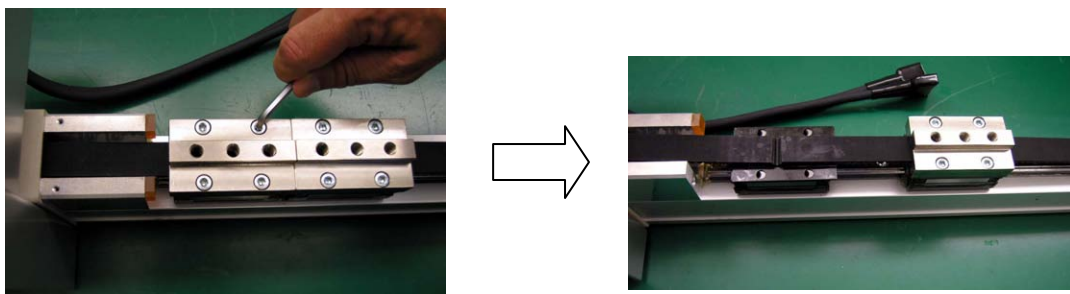

11) Remove the driving belt.

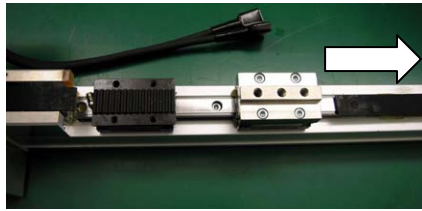

Pull out the driving belt in the direction shown with an arrow.

Opposite Side of Motor

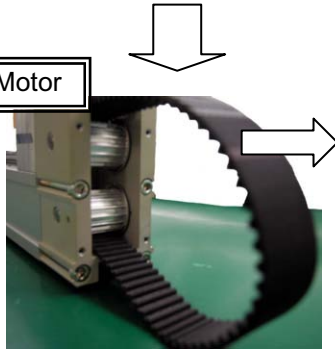

Pull out the driving belt in the direction shown with an arrow.

Motor Side

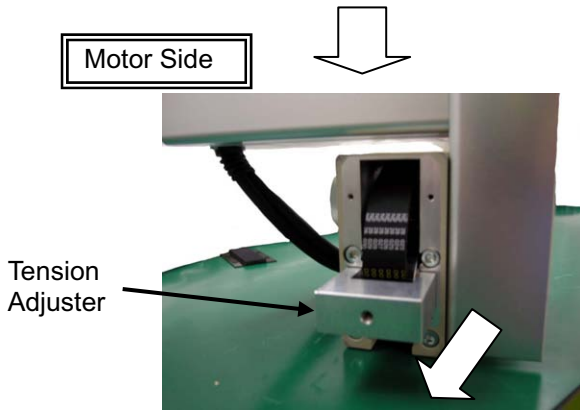

Pull out the tension adjuster in the direction shown with an arrow.

Motor Side

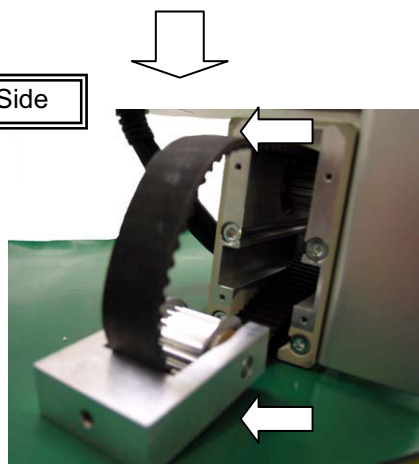

Pull the driving belt on the top and the bottom in the direction shown with the arrows to take it out completely.

12) Attach the replacement driving belt.

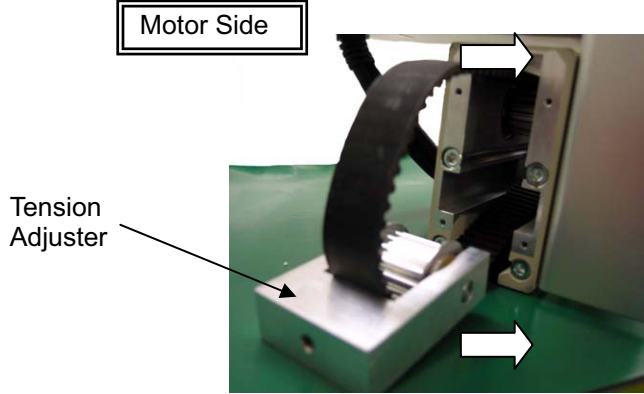

After putting the replacement driving belt through the tension adjuster, insert the belt on the top and the bottom in the direction shown with the arrows.

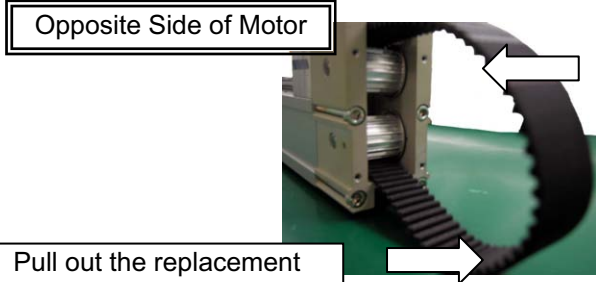
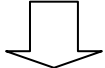

2) Insert the replacement driving belt on the top and the bottom in the direction shown with the arrows.

1) Pull out the replacement driving belt at the bottom in the direction show with the arrow.

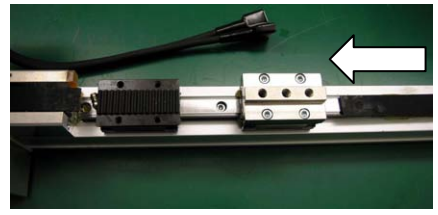
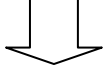

Insert the driving belt in the direction shown with the arrow.

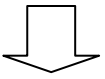

To the next page

Motor Side

Tension Adjuster
Tension Adjustment Bolt
End Cover

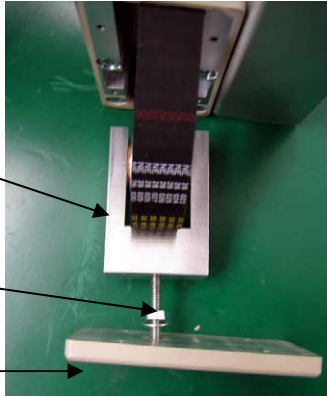

Using the tension adjustment bolt, attach the end cover to the tension adjuster.

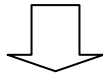

Tension Adjuster

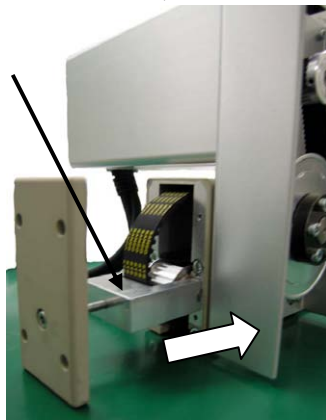

Push in the tension adjuster completely in the direction shown with the arrow. (Use a hexagon wrench with the distance to the opposite side of 4mm.)

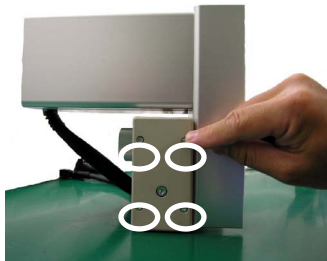
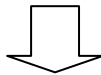

Attach the end cover. (Use a hexagon wrench with the distance to the opposite side of 2.5mm.)

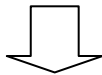

Teeth on Attachment Part

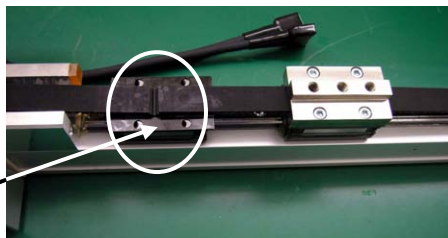

Pull the replacement driving belt to align it with the teeth on the attachment part.

(Note) Have the driving belt to make its ends adjusted in the center of the attachment teeth part. Cut the driving belt if it is too long.

- 13) Attach the driving belt retainer plate.
 (Use M4-sized hex wrench for NM. Use M5-sized hex wrench for WM.)

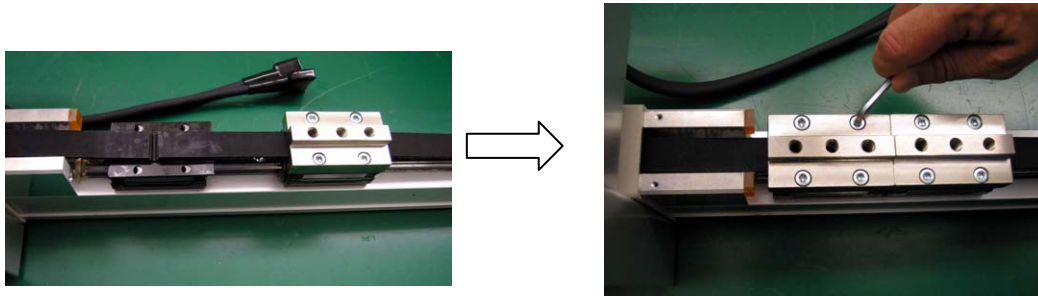

- 14) Adjust the belt to the specified tension.
- Set the slider at the point 400mm from the center of the pulley.
 - Set a push-pull gauge at the point 200mm from the center of the pulley.
- Adjust the tension of the belt with the tension adjustment bolt to make the clearance between the inside of the belt and the top surface of LM guide 0mm when applying the specified load.

Load Specifications	
NM	3kgf
WM	7kgf

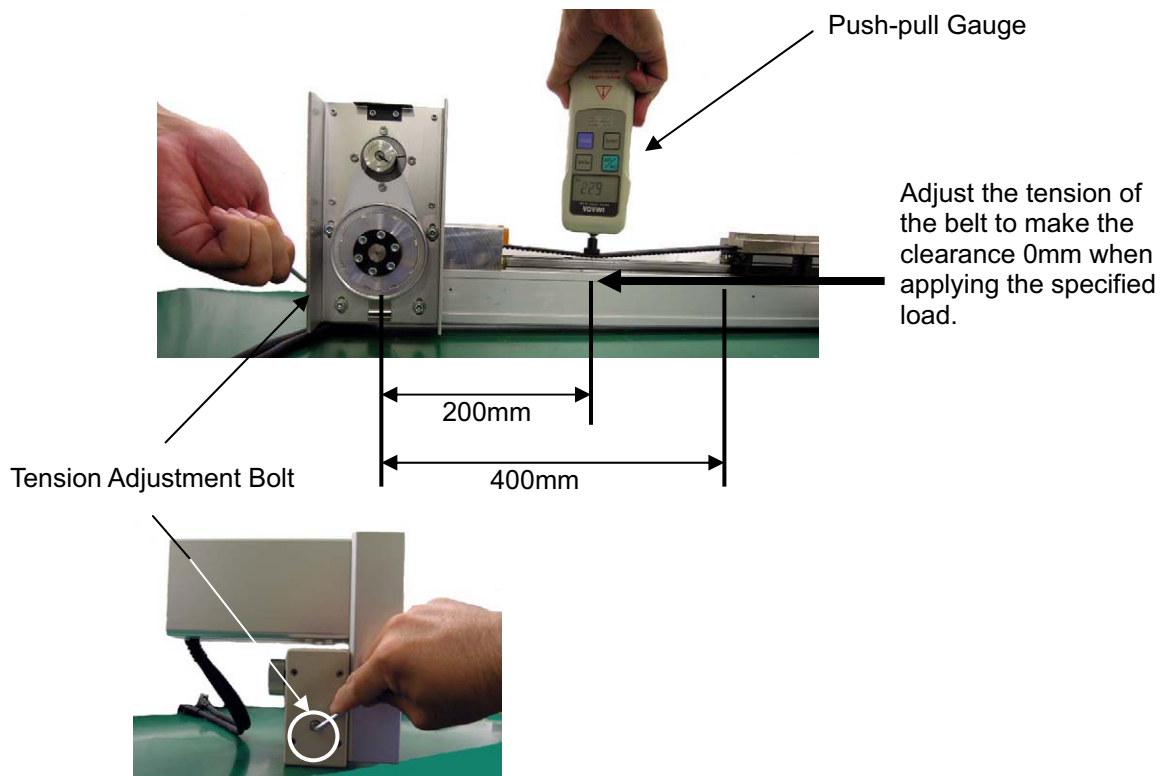

- 15) Tighten the locknut to make the tension adjustment bolts fixed.
(Use a spanner wrench of 8mm.)

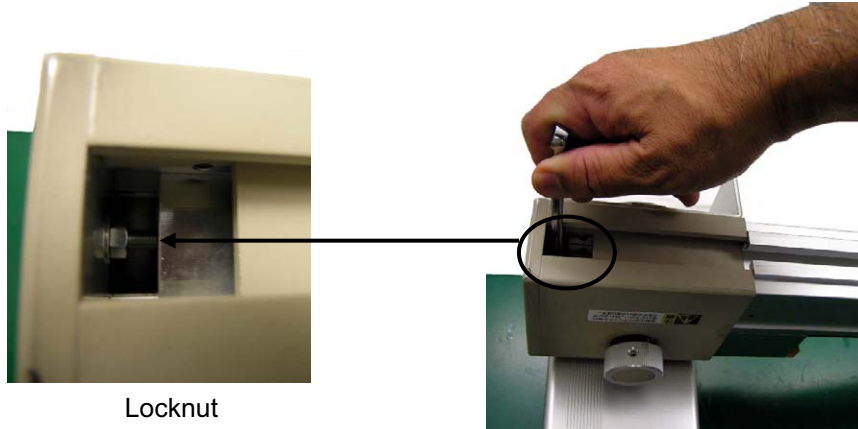

- 16) Make an adjustment to reconstruct the home position.
1. Attach the cover on one side with the marking and move the slider to a position where the Z-phase to be the home turns ON. It is the point 9mm away from the mechanical end for both standard home type and reversed home type.

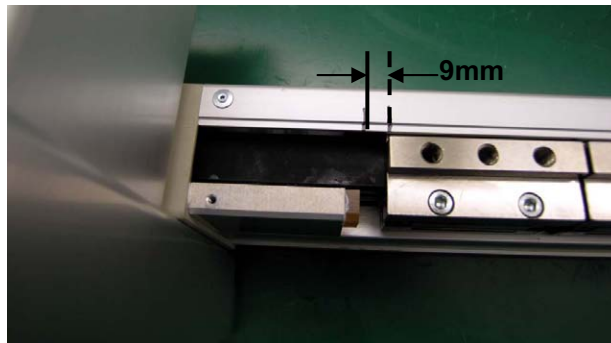

2. On the motor side, it should be the position of the first alignment marks. Align the marks if they are misaligned.

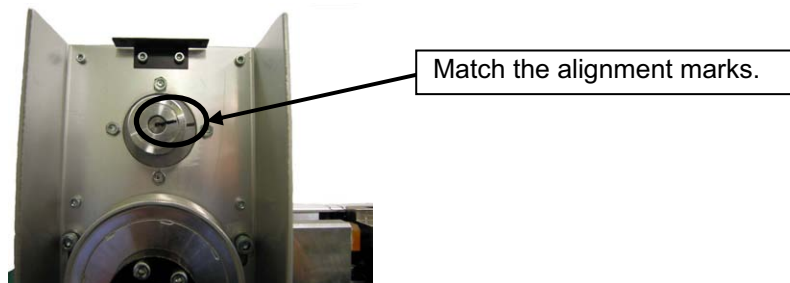

3. Hang the deceleration belt while holding the pulleys so both of them would not move during the work.

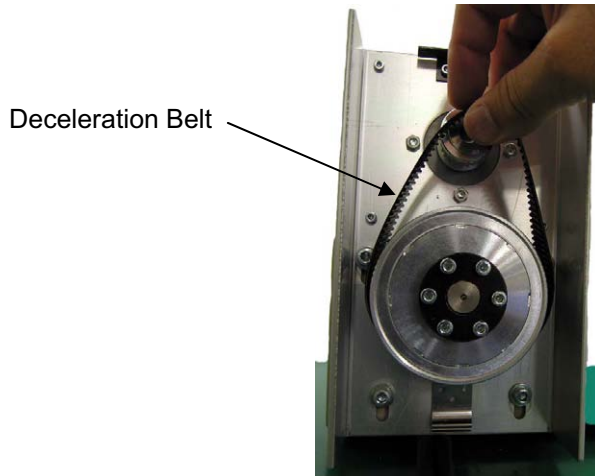

4. Put a robust rope in a ring shape (or a long cable band) around the motor cover, and pull it on a tension gauge. While it is pulled up with the specified tensile force, tighten the screws at four points. (Use a hexagon wrench with the distance to the opposite side of 4mm.) (Pay attention to the slider and motor shaft so they would not move while in the work.)

Specified Tensile Force	
NM	5kgf
WM	10kgf

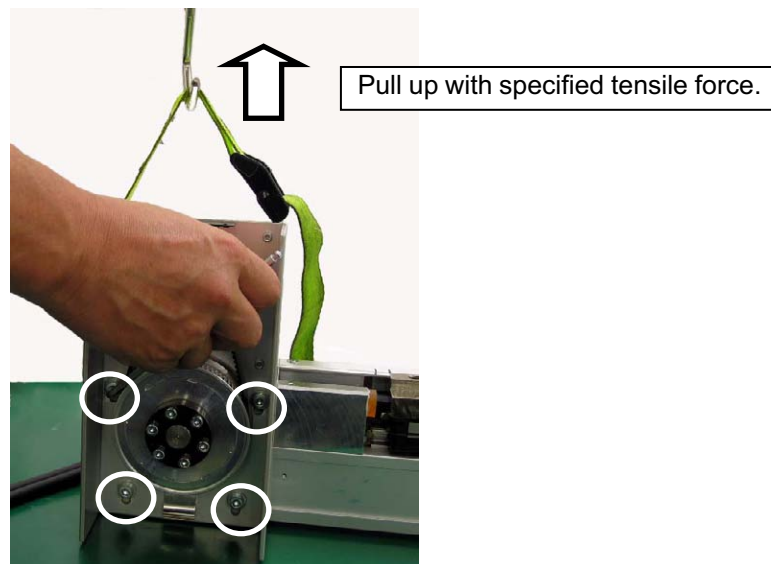



- 17) Attach the slider cover on the other side.
Tighten the fixing screws on the top and side surfaces.
(Use a hexagon wrench with the distance to the opposite side of 1.5mm.)



- 18) Put the end cover on the opposite side of the motor.
(Use a hexagon wrench with the distance to the opposite side of 2.5mm.)

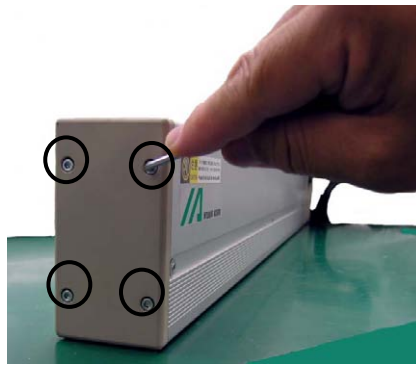

- 19) Hang the hook on the bottom of the pulley cover to the corner catch, and tighten screws on the top.
(Use a hexagon wrench with the distance to the opposite side of 1.5mm.)

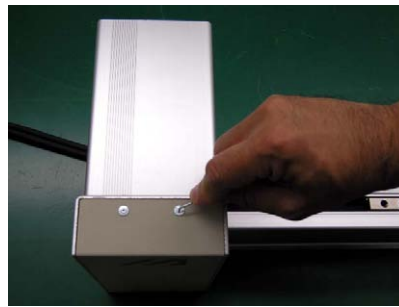
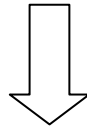
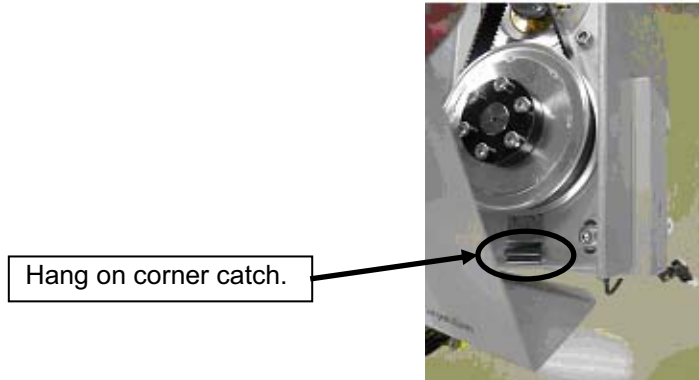

- 20) Execute the home-return operation on the PC (PC software) or a teaching pendant. (for the absolute encoder, the absolute reset is required.)
Check the amount of misalignment to the original home position.
If there is a misalignment, fine-tune the home-return offset in Parameter No. 22 for E-Con and SCON Controllers. For P-Driver Controller, fine-tune the home-return offset in Position Control Data No. 17. For SSEL Controller and X-SEL Controller, use Home Preset in Each Axis Parameter No. 12 for adjustment.

5.8 How to Replace the Deceleration Belt

[Items required for the Replacement]

- Replacement Driving Belt
- Hexagon Wrench Set
- Measure
- Personal Computer or Teaching Pendant
- Tension Gauge (Tension of 10kgf or more available)
- Strong Thread (or Long Harness Belt)

[Replacement Operation Outline]

- 1) Loosen the pulley fixing screw on the driving belt side to take off the belt.
- 2) Perform the homing operation.
Loosen the deceleration belt, affix the slider at the point of 9mm from the mechanical end on the home side, and then affix the motor shaft at the alignment mark.
- 3) Put the new replacement deceleration belt and tighten the pulley fixing screw on the driving belt side up to get the specified tension.
- 4) Perform a home-return operation with using PC or a teaching pendant to check the amount of misalignment from the original home position. In case there is misalignment, adjust the position with Home-Return Offset for E-Con, P-Driver and SCON Controllers. For SSEL Controllers and X-SEL Controllers, use Home Preset for adjustment.

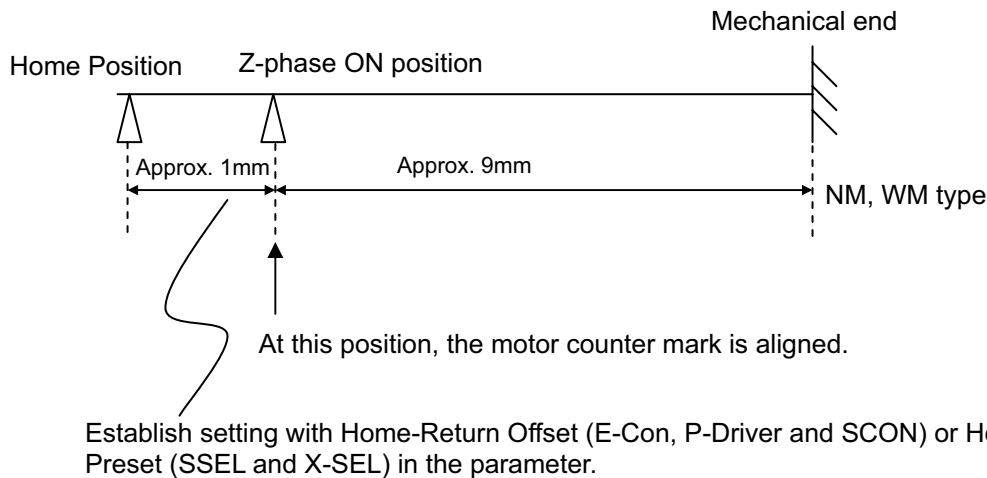

[Procedure]

- 1) Detach the pulley cover and check the direction of motor shaft rotation when moving the slider from the home position side to the mechanical end side. (the rotational direction differs depending on the motor attachment position, thus checking is necessary.)

Detach the pulley cover.
(Use a hexagon wrench with the distance to the opposite side of 1.5 mm.)



Confirm the motor shaft rotating direction.

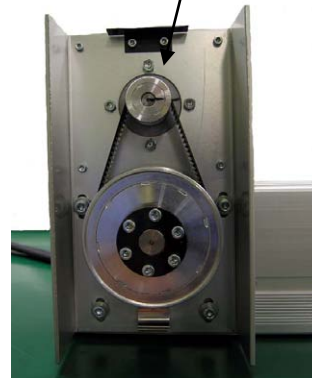

- 2) Move the slider to a point where Z-phase to be the home turns ON.
The point should be 9mm away from the mechanical end for both home standard type and home reversed type.
Put marks on the mechanical end and the point of Z-phase.

Put a mark on the mechanical end
where slider was pushed against.

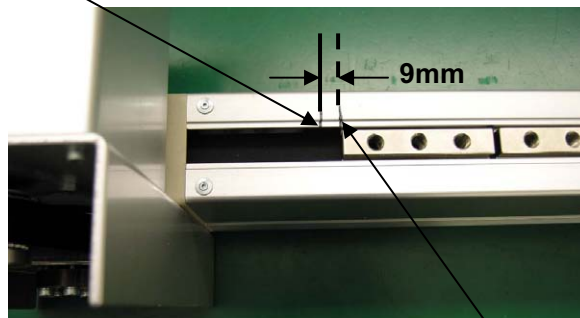

Move the slider back away for 9mm from the
mechanical end.
Put another mark on this Z-phase point.



- 3) Loosen the pulley fixing screws on the driving belt side.
(Use a hexagon wrench with the distance to the opposite side of 4mm.)

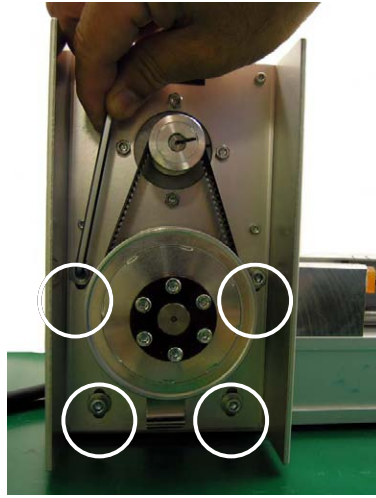

- 4) Remove the deceleration belt to make the pulley free.

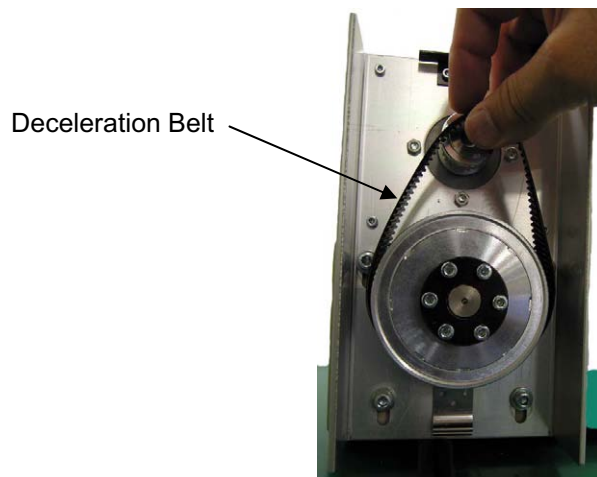

- 5) After attaching the new replacement deceleration belt, make an adjustment to reconstruct the home position.
 1. Attach the cover on one side with the marking and move the slider to a position where the Z-phase to be the home turns ON. It is the point 9mm away from the mechanical end for both standard home type and reversed home type.

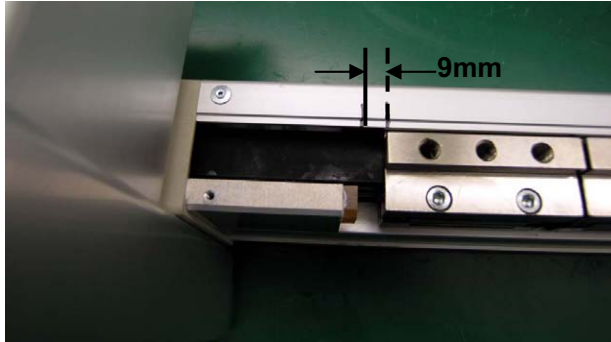

2. On the motor side, it should be the position of the first alignment marks. Align the marks if they are misaligned.

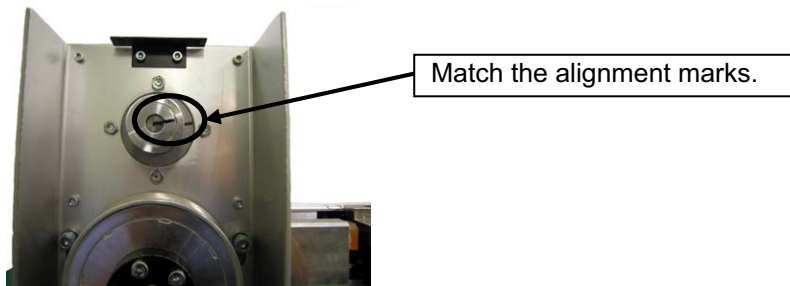

3. Hang the deceleration belt while holding the pulleys so both of them would not move during the work.

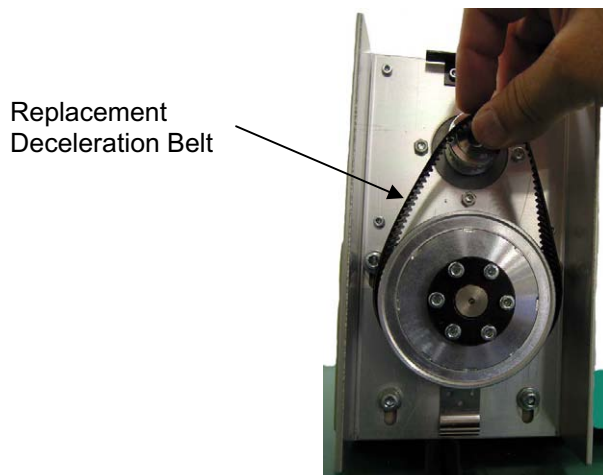

4. Put a robust rope in a ring shape (or a long cable band) around the motor cover, and pull it on a tension gauge.
 While it is pulled up with the specified tensile force, tighten the screws at four points.
 (Use a hexagon wrench with the distance to the opposite side of 4mm.)
 (Pay attention to the slider and motor shaft so they would not move while in the work.)

Specified Tensile Force	
NM	5kgf
WM	10kgf

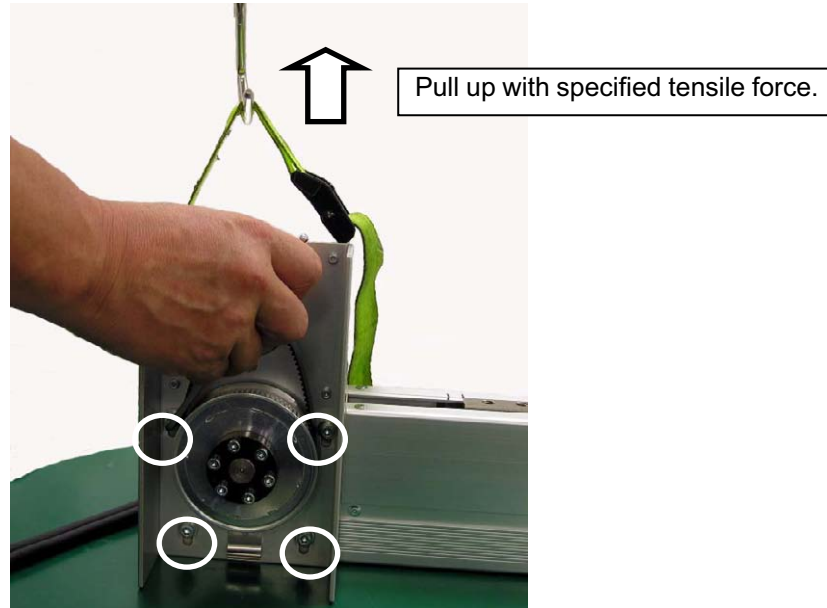

- 6) Hang the hook on the bottom of the pulley cover to the corner catch, and tighten screws on the top. (Use a hexagon wrench with the distance to the opposite side of 1.5mm.)

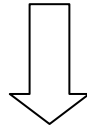
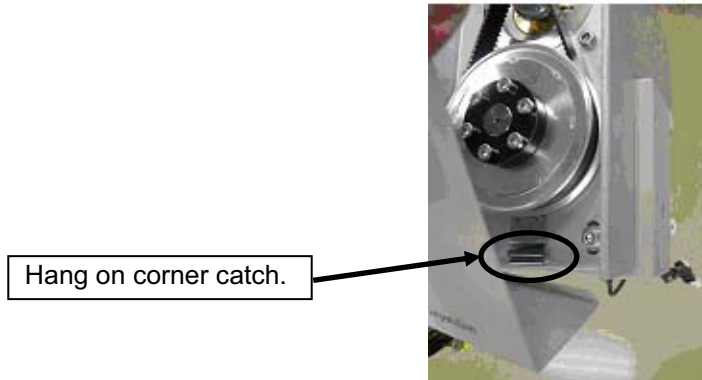

- 7) Execute the home-return operation on the PC (PC software) or a teaching pendant. (for the absolute encoder, the absolute reset is required.)
Check the amount of misalignment to the original home position.
If there is a misalignment, fine-tune the home-return offset in Parameter No. 22 for E-Con and SCON Controllers. For P-Driver Controller, fine-tune the home-return offset in Position Control Data No. 17. For SSEL Controller and X-SEL Controller, use Home Preset in Each Axis Parameter No. 12 for adjustment.

5.9 Motor Replacement

[Items required for the Replacement]

- Replacement Motor (Refer to the picture at right)
(Confirm that the counter mark is attached)
- Hexagon Wrench Set
- Phillips Screwdriver
- Measure
- Personal Computer or Teaching Pendant
- Tension Gauge (Tension of 10kgf or more available)
- Strong Thread (or Long Harness Belt)



[Replacement Operation Outline]

- 1) Loosen the pulley fixing screw on the driving belt side to detach the deceleration belt, and replace the motor.
- 2) Perform the homing operation.
Loosen the deceleration belt, affix the slider at the point of 9mm from the mechanical end on the home side, and then affix the motor shaft at the alignment mark.
- 3) Put the deceleration belt and tighten the pulley fixing screw on the driving belt side up to get the specified tension.
- 4) Perform a home-return operation with using PC or a teaching pendant to check the amount of misalignment from the original home position. In case there is misalignment, adjust the position with Home-Return Offset for E-Con, P-Driver and SCON Controllers. For SSEL Controllers and X-SEL Controllers, use Home Preset for adjustment.

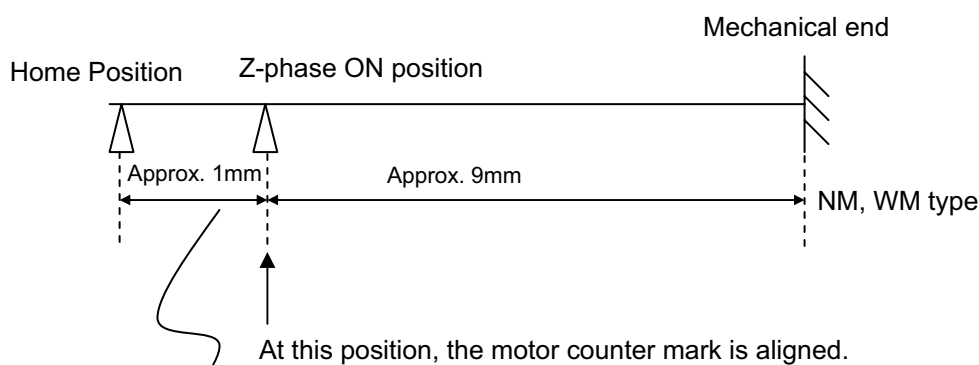

Establish setting with Home-Return Offset (E-Con, P-Driver and SCON) or Home Preset (SSEL and X-SEL) in the parameter.

[Procedure]

- 1) Detach the pulley cover and check the direction of motor shaft rotation when moving the slider from the home position side to the mechanical end side. (the rotational direction differs depending on the motor attachment position, thus checking is necessary.)

Detach the pulley cover.
(Use a hexagon wrench with the distance to the opposite side of 1.5mm.)



Confirm the motor shaft rotating direction.

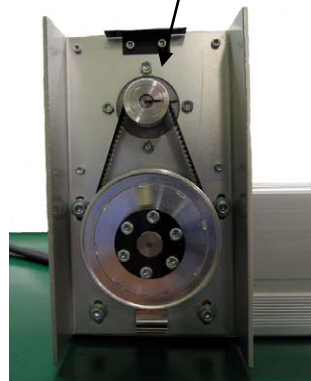

- 2) Move the slider to a point where Z-phase to be the home turns ON.
The point should be 9mm away from the mechanical end for both home standard type and home reversed type.
Put marks on the mechanical end and the point of Z-phase.

Put a mark on the mechanical end
where slider was pushed against.

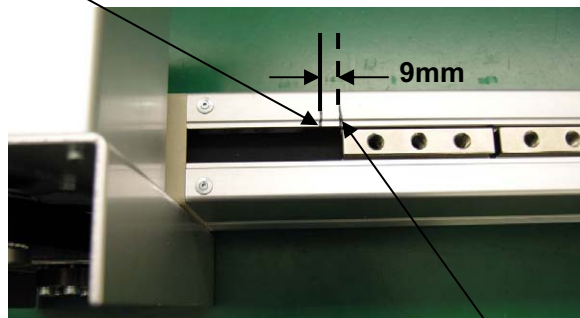

Move the slider back away for 9mm from the
mechanical end.
Put another mark on this Z-phase point.



- 3) Loosen the pulley fixing screws on the driving belt side.
(Use a hexagon wrench with the distance to the opposite side of 4mm.)

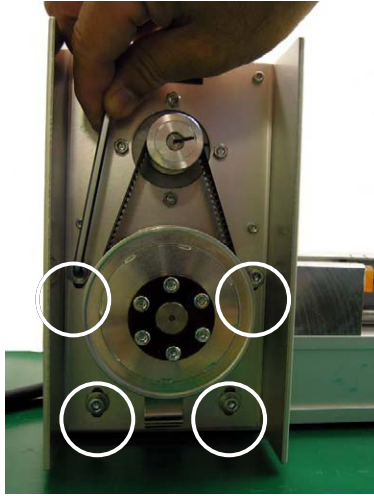

- 4) Remove the deceleration belt to make the pulley free.

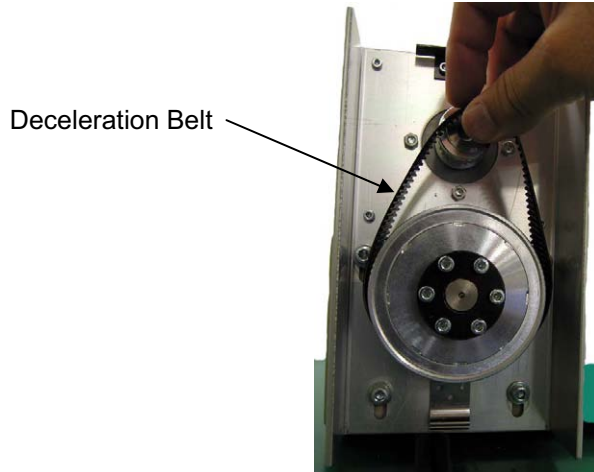

- 5) Detach the lid on the motor cover.
(Use a hexagon wrench with the distance to the opposite side of 1.5mm.)

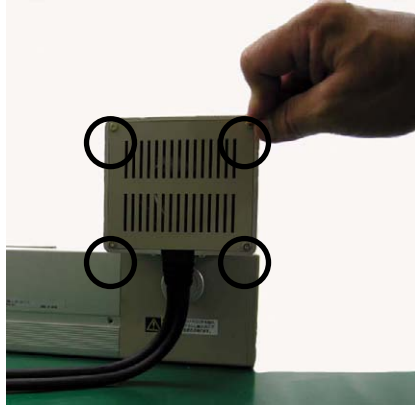

- 6) Unplug the motor cables and encoder cables on the motor side and actuator side.

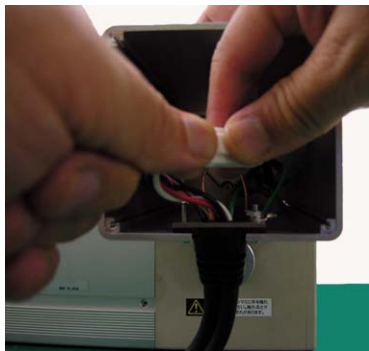

- 7) Detach the FG cable. (Use a Phillips screwdriver.)

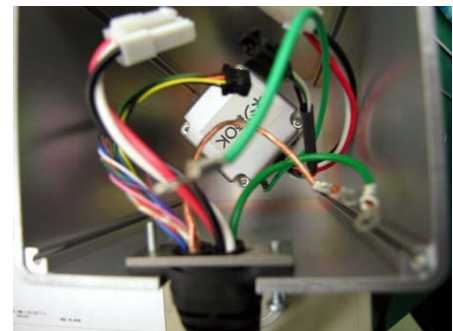
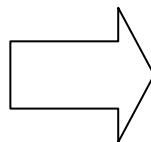
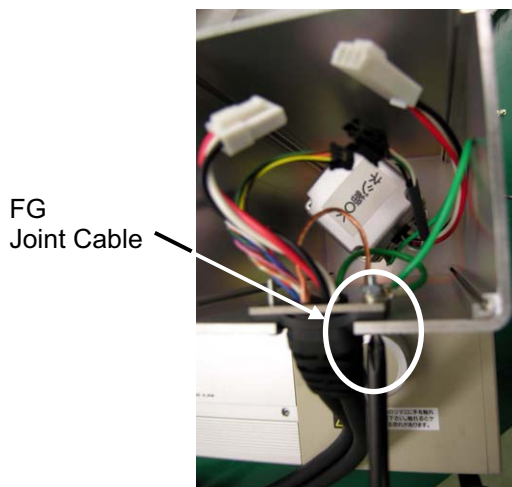

- 8) Detach the motor cover.
(Use a hexagon wrench with the distance to the opposite side of 2.5mm.)

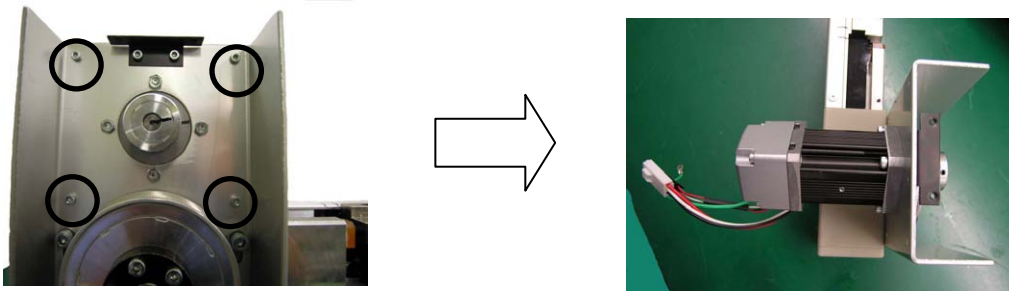

- 9) Detach the motor.
(Use a hexagon wrench with the distance to the opposite side of 2mm.)
Check the position (angle) of the alignment marks before taking off the motor.

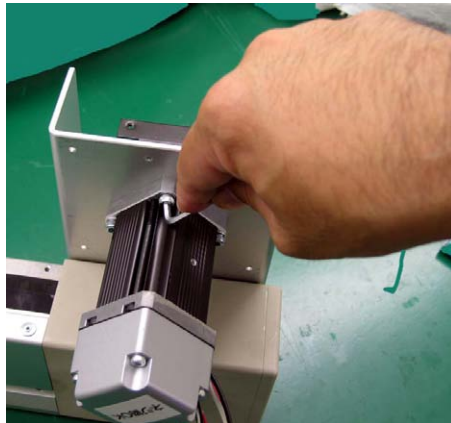
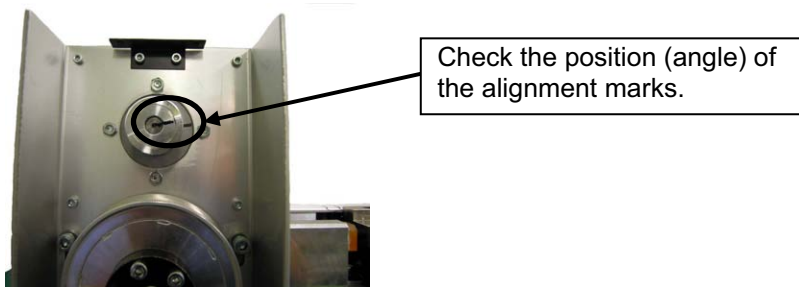

- 10) Insert the replacement motor while matching the position (angle) of the alignment marks, and then attach the motor.
(Use a hexagon wrench with the distance to the opposite side of 2mm.)

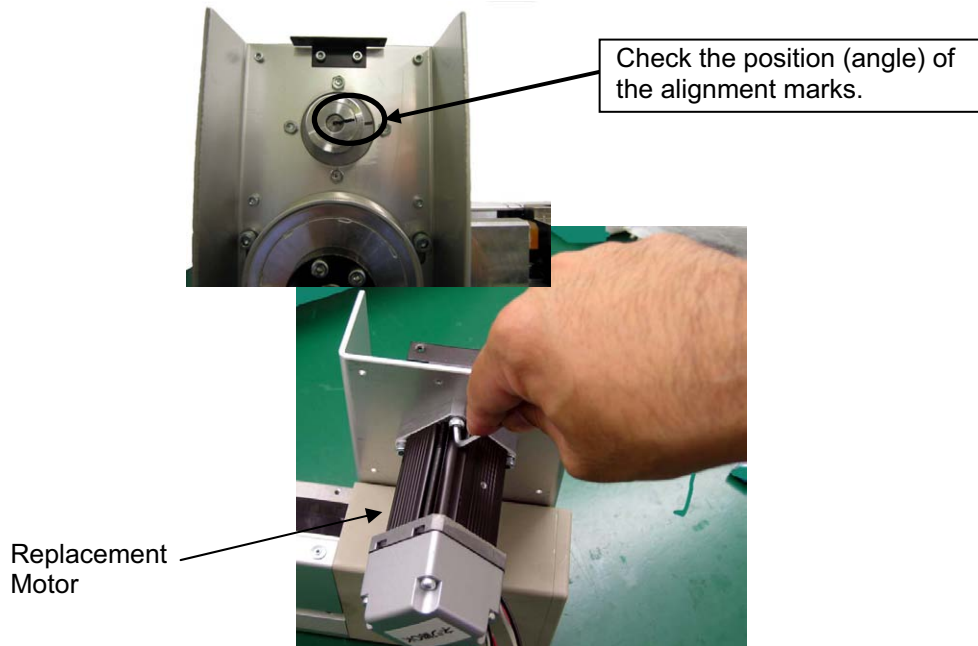

- 11) Attach the motor cover.
(Use a hexagon wrench with the distance to the opposite side of 2.5mm.)

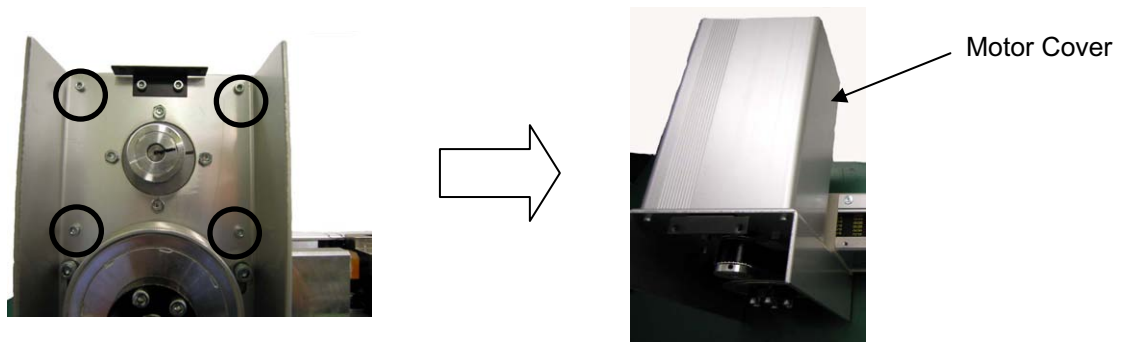

12) Attach the FG cable. (Use a Phillips screwdriver.)

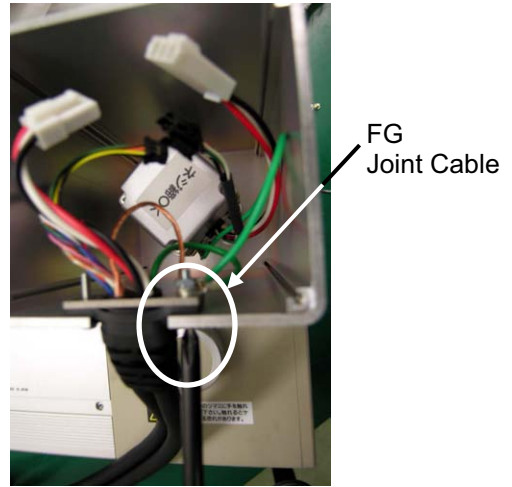
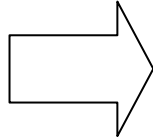
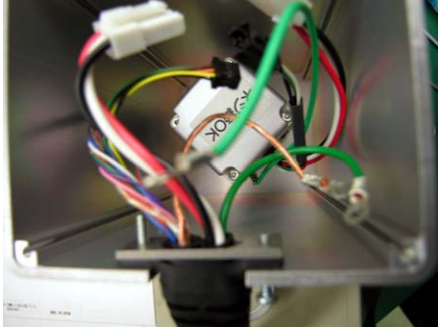

13) Join the motor cables and encoder cables on the motor side and actuator side.



14) Attach the lid on the motor cover.
(Use a hexagon wrench with the distance to the opposite side of 1.5mm.)

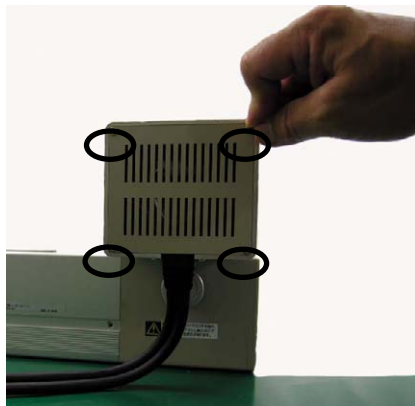

15) After attaching the new replacement deceleration belt, make an adjustment to reconstruct the home position.

1. Attach the cover on one side with the marking and move the slider to a position where the Z-phase to be the home turns ON. It is the point 9mm away from the mechanical end for both standard home type and reversed home type.

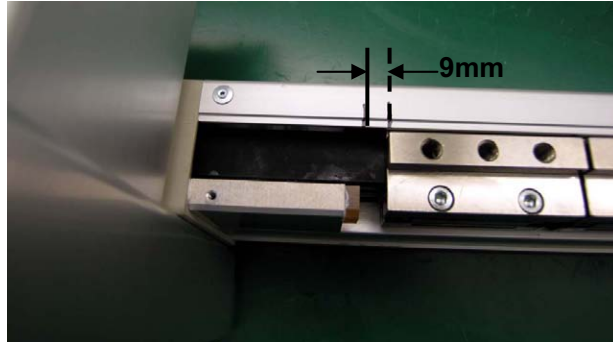

2. On the motor side, it should be the position of the first alignment marks. Align the marks if they are misaligned.

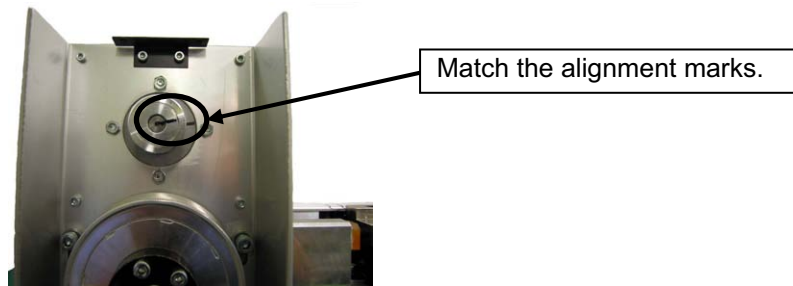

3. Hang the deceleration belt while holding the pulleys so both of them would not move during the work.

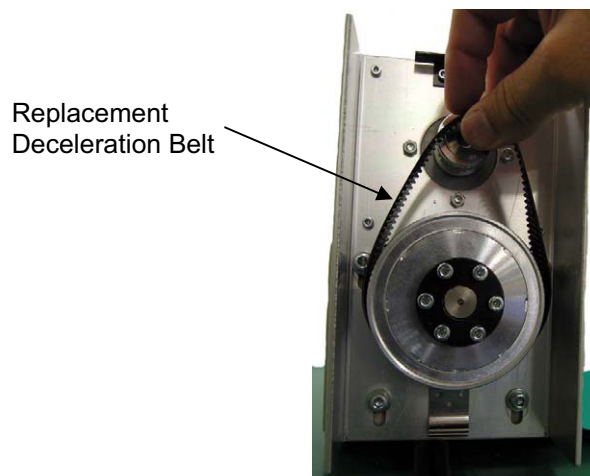

4. Put a robust rope in a ring shape (or a long cable band) around the motor cover, and pull it on a tension gauge.

While it is pulled up with the specified tensile force, tighten the screws at four points.
 (Use a hexagon wrench with the distance to the opposite side of 4mm.)
 (Pay attention to the slider and motor shaft so they would not move while in the work.)

Specified Tensile Force

NM	5kgf
WM	10kgf

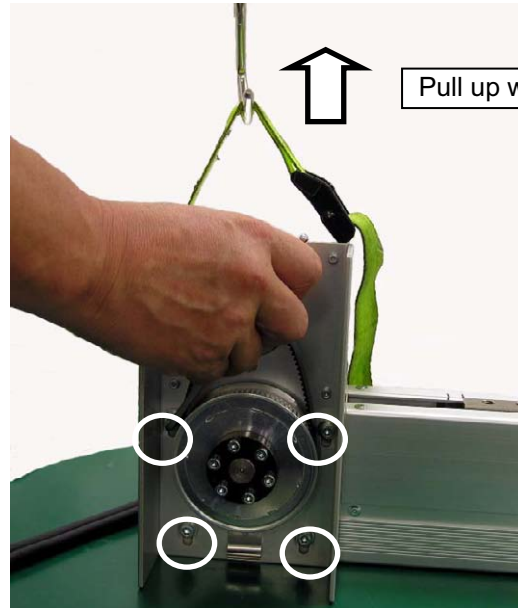

- 16) Hang the hook on the bottom of the pulley cover to the corner catch, and tighten screws on the top.
(Use a hexagon wrench with the distance to the opposite side of 1.5mm.)

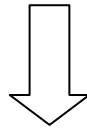
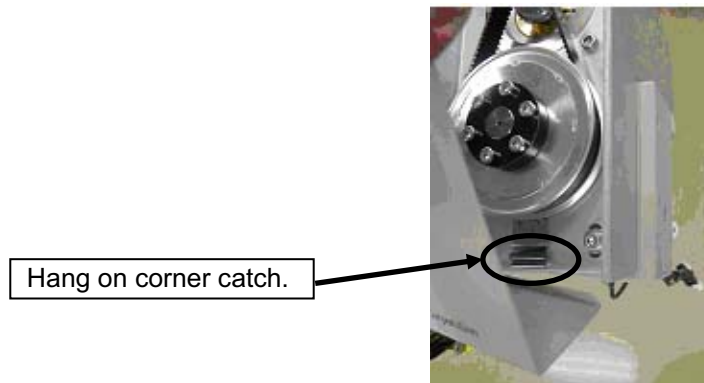

- 17) Execute the home-return operation on the PC (PC software) or a teaching pendant. (for the absolute encoder, the absolute reset is required.)
Check the amount of misalignment to the original home position.
If there is a misalignment, fine-tune the home-return offset in Parameter No. 22 for E-Con and SCON Controllers. For P-Driver Controller, fine-tune the home-return offset in Position Control Data No. 17. For SSEL Controller and X-SEL Controller, use Home Preset in Each Axis Parameter No. 12 for adjustment.

6. External Dimensions

6.1 FS-11NM-60 (Single Slider), FS-12NM-60 (Double Slider)

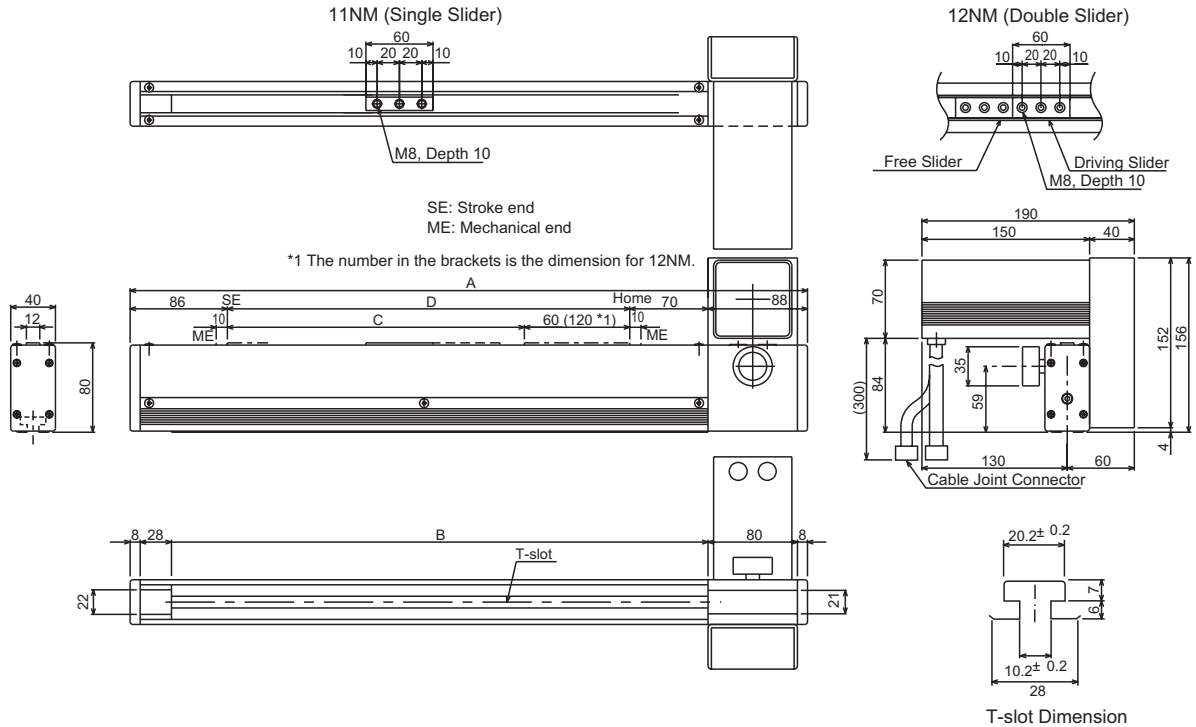

FS-11NM-60 (Single Slider)

Stroke	300	400	500	600	700	800	900	1000
A	604	704	804	904	1004	1104	1204	1304
B	480	580	680	780	880	980	1080	1180
C	300	400	500	600	700	800	900	1000
D	360	460	560	660	760	860	960	1060
Weight [kg]	5.0	5.4	5.8	6.2	6.6	7.0	7.4	7.8

FS-12NM-60 (Double Slider)

Stroke	300	400	500	600	700	800	900	1000
A	704	804	904	1004	1104	1204	1304	1404
B	580	680	780	880	980	1080	1180	1280
C	340	440	540	640	740	840	940	1040
D	460	560	660	760	860	960	1060	1160
Weight [kg]	5.7	6.0	6.5	6.9	7.3	7.7	8.1	8.5

6.2 FS-11NM-100 (Single Slider), FS-12NM-100 (Double Slider)

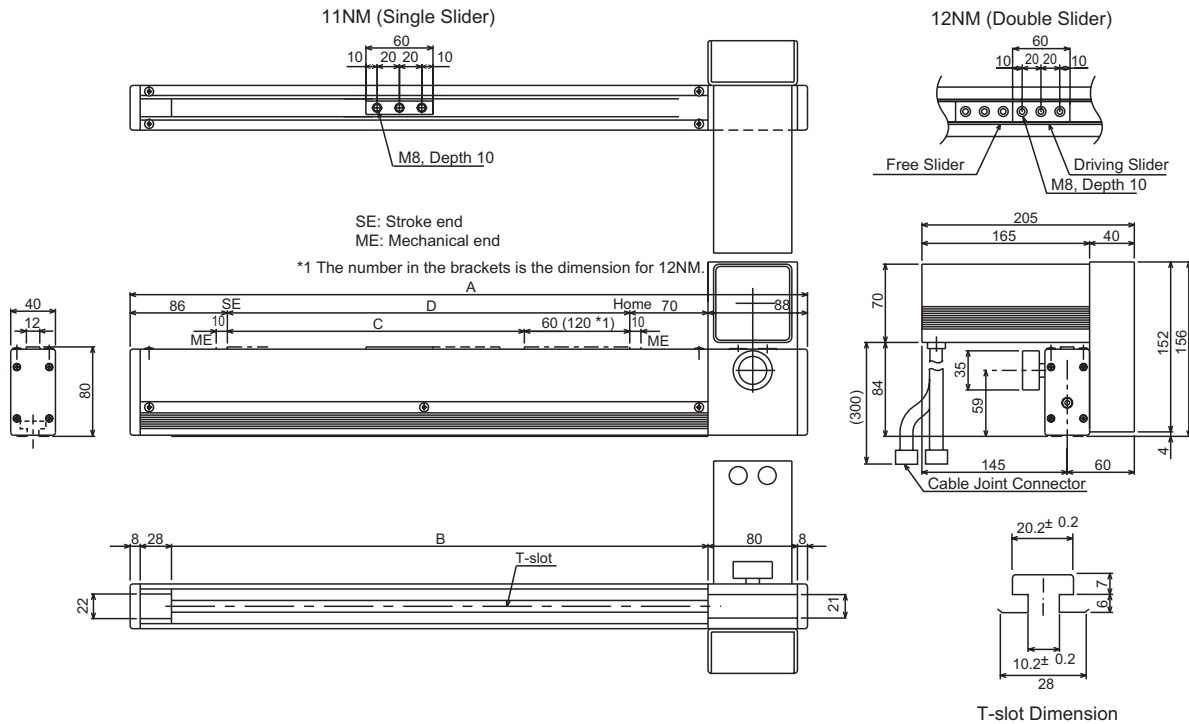

FS-11NM-100 (Single Slider)

Stroke	300	400	500	600	700	800	900	1000
A	604	704	804	904	1004	1104	1204	1304
B	480	580	680	780	880	980	1080	1180
C	300	400	500	600	700	800	900	1000
D	360	460	560	660	760	860	960	1060
Weight [kg]	5.0	5.4	5.8	6.2	6.6	7.0	7.4	7.8

FS-12NM-100 (Double Slider)

Stroke	300	400	500	600	700	800	900	1000
A	704	804	904	1004	1104	1204	1304	1404
B	580	680	780	880	980	1080	1180	1280
C	340	440	540	640	740	840	940	1040
D	460	560	660	760	860	960	1060	1160
Weight [kg]	5.7	6.0	6.5	6.9	7.3	7.7	8.1	8.5

6.3 FS-11NO-0 (Single Slider), FS-12NO-0 (Double Slider)

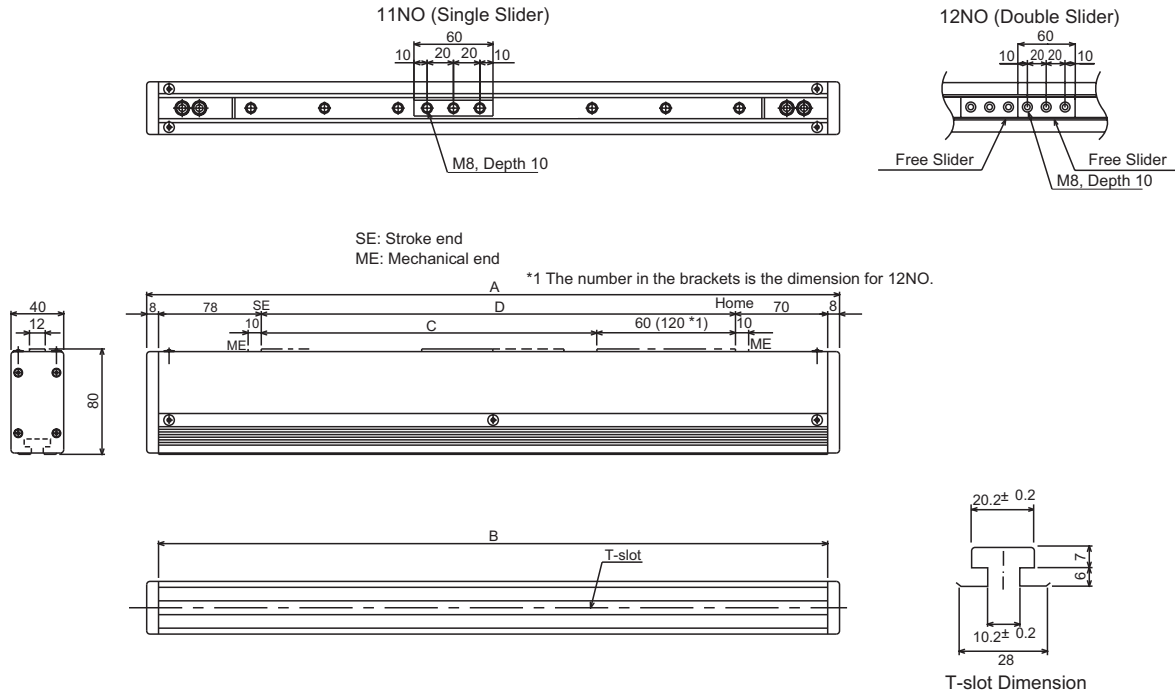

FS-11NO-0 (Single Slider)

Stroke	300	400	500	600	700	800	900	1000
A	524	624	724	824	924	1024	1124	1224
B	508	608	708	808	908	1008	1108	1208
C	300	400	500	600	700	800	900	1000
D	360	460	560	660	760	860	960	1060
Weight [kg]	2.4	2.8	3.2	3.6	4.1	4.4	4.8	5.2

FS-12NO-0 (Double Slider)

Stroke	300	400	500	600	700	800	900	1000
A	624	724	824	924	1024	1124	1224	1324
B	608	708	808	908	1008	1108	1208	1308
C	340	440	540	640	740	840	940	1040
D	460	560	660	760	860	960	1060	1160
Weight [kg]	3.1	3.5	3.9	4.3	4.8	5.1	5.5	5.9

6.4 FS-11WM-100 (Single Slider), FS-12WM-100 (Double Slider)

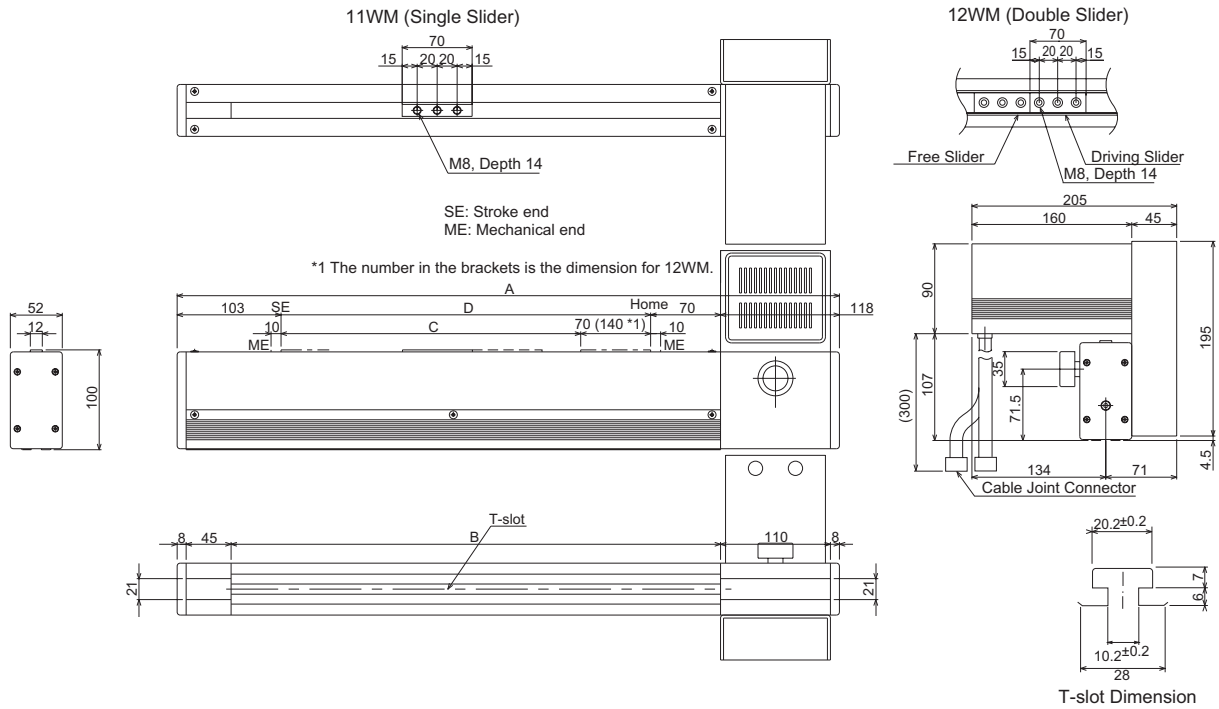

FS-11WM-100 (Single Slider)

Stroke	300	400	600	800	1000	1500	2000	2500
A	661	761	961	1161	1361	1861	2361	2861
B	490	590	790	990	1190	1690	2190	2690
C	300	400	600	800	1000	1500	2000	2500
D	370	470	670	870	1070	1570	2070	2570
Weight [kg]	8.7	9.3	10.5	11.7	12.9	15.9	18.9	21.9

FS-12WM-100 (Double Slider)

Stroke	300	400	500	600	700	800	900	1000
A	624	724	824	924	1024	1124	1224	1324
B	608	708	808	908	1008	1108	1208	1308
C	340	440	540	640	740	840	940	1040
D	460	560	660	760	860	960	1060	1160
Weight [kg]	3.1	3.5	3.9	4.3	4.8	5.1	5.5	5.9

6.5 FS-11WM-200 (Single Slider), FS-12WM-200 (Double Slider)

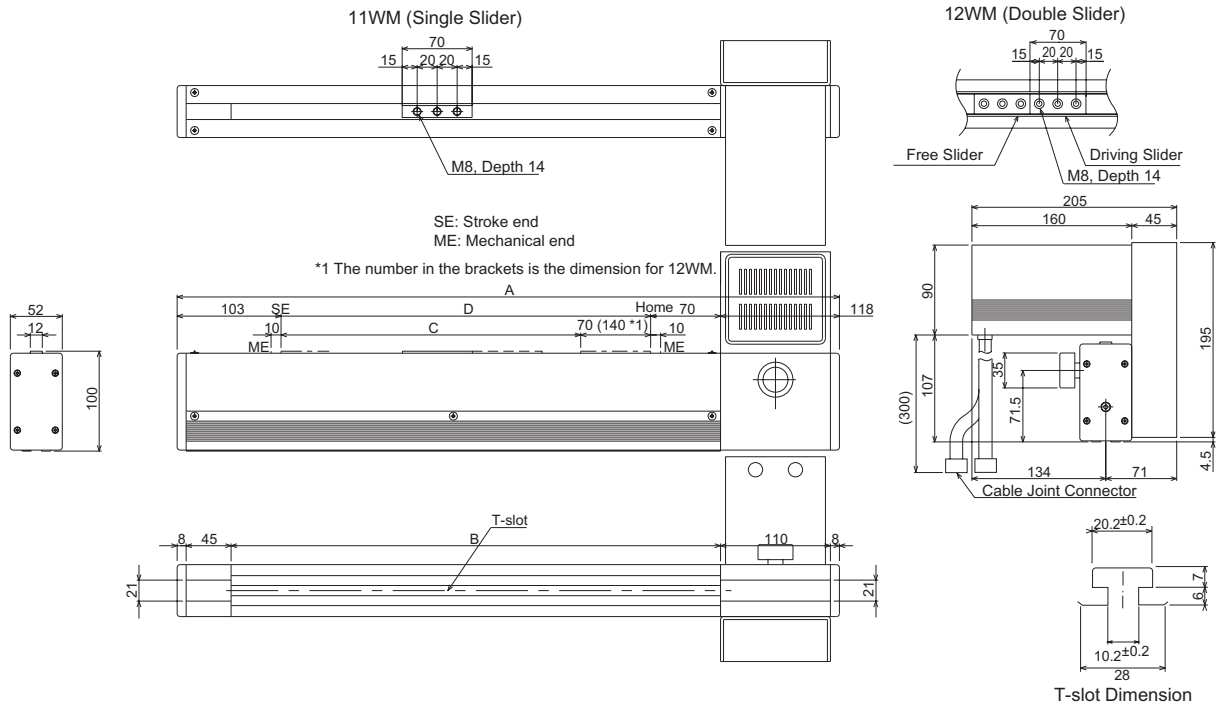

FS-11WM-200 (Single Slider)

Stroke	300	400	600	800	1000	1500	2000	2500
A	661	761	961	1161	1361	1861	2361	2861
B	490	590	790	990	1190	1690	2190	2690
C	300	400	600	800	1000	1500	2000	2500
D	370	470	670	870	1070	1570	2070	2570
Weight [kg]	9.8	10.4	11.6	12.8	14.0	17.0	20.0	23.0

FS-12WM-200 (Double Slider)

Stroke	300	400	600	800	1000	1500	2000	2500
A	761	861	1061	1261	1461	1961	2461	2961
B	590	690	890	1090	1290	1790	2290	2790
C	330	430	630	830	1030	1530	2030	2530
D	470	570	770	970	1170	1670	2170	2670
Weight [kg]	11.0	11.6	12.8	14.0	15.2	18.2	21.2	24.2

6.6 FS-11WO-0 (Single Slider), FS-12WO-0 (Double Slider)

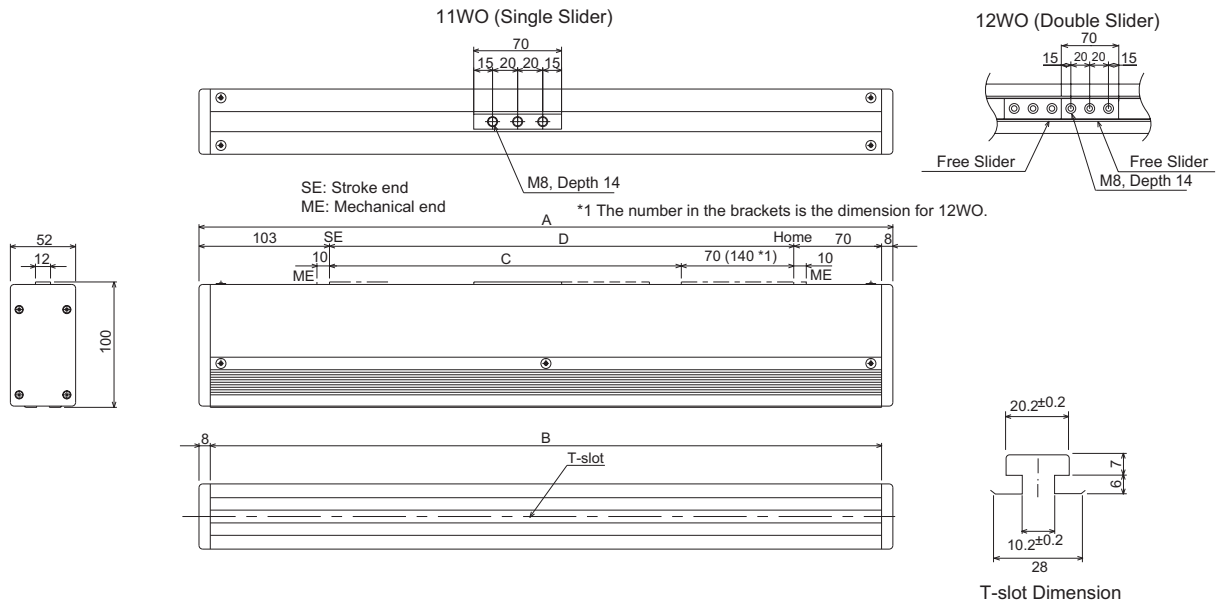

FS-11WO-0 (Single Slider)

Stroke	300	400	600	800	1000	1500	2000	2500
A	551	651	851	1051	1251	1751	2251	2751
B	535	635	835	1035	1235	1735	2235	2735
C	300	400	600	800	1000	1500	2000	2500
D	370	470	670	870	1070	1570	2070	2570
Weight [kg]	4.9	5.6	6.7	8.3	9.6	12.9	16.3	19.6

FS-12WO-0 (Double Slider)

Stroke	300	400	600	800	1000	1500	2000	2500
A	651	751	951	1151	1351	1851	2351	2851
B	635	735	935	1135	1335	1835	2335	2835
C	330	430	630	830	1030	1530	2030	2530
D	470	570	770	970	1170	1670	2170	2670
Weight [kg]	5.6	6.2	7.6	8.9	10.2	13.6	16.9	20.3

6.7 FS-11LM-400 (Single Slider), FS-12LM-400 (Double Slider)

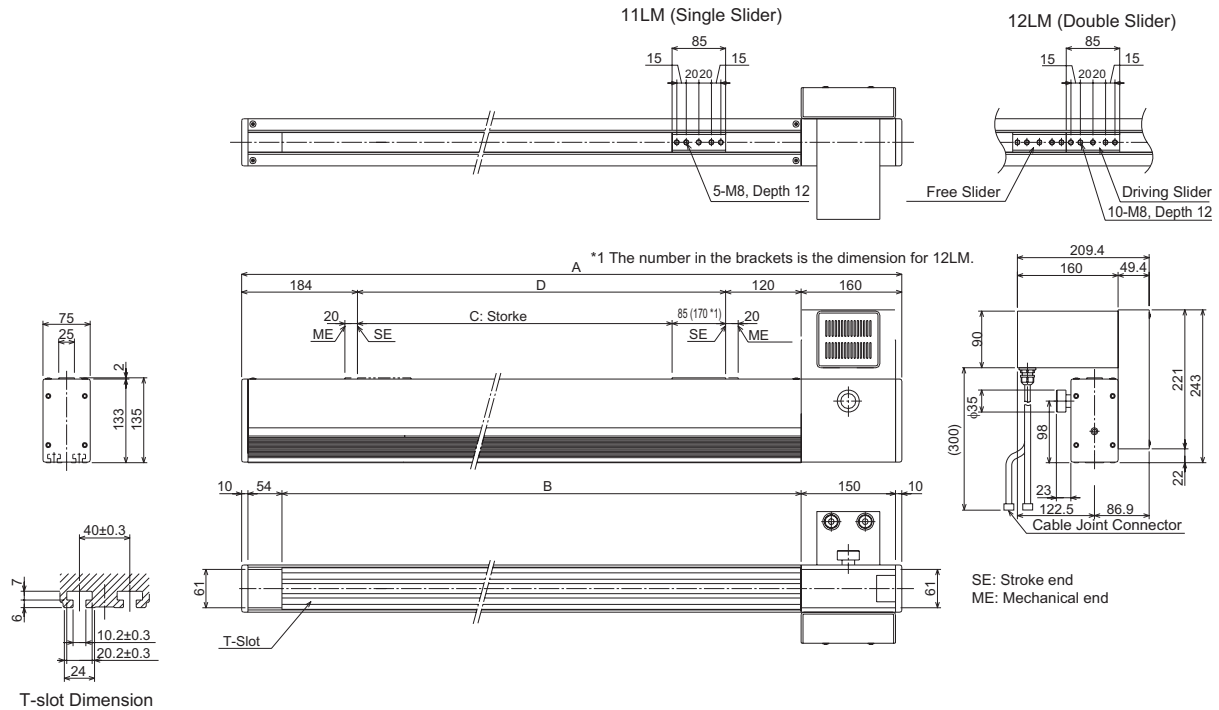

FS-11LM-400 (Single Slider)

Stroke	1000	1500	2000	2500	3000
A	1549	2049	2549	3049	3549
B	1325	1825	2325	2825	3325
C	1000	1500	2000	2500	3000
D	1085	1585	2085	2585	3085
Weight [kg]	28	34	40	47	53

FS-12LM-400 (Double Slider)

Stroke	1000	1500	2000	2500	3000
A	1649	2149	2649	3149	3649
B	1425	1925	2425	2925	3425
C	1015	1515	2015	2515	3015
D	1185	1685	2185	2685	3185
Weight [kg]	31	37	43	49	56

6.8 FS-11HM-400 (Single Slider), FS-12HM-400 (Double Slider)

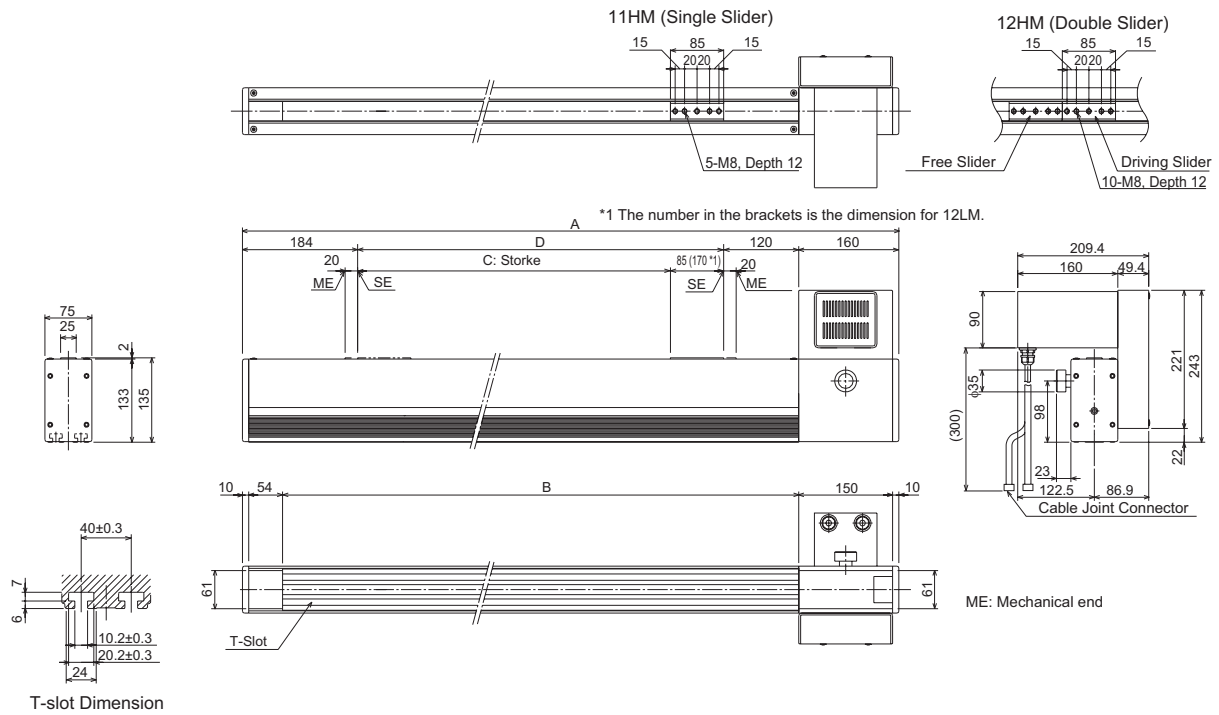

FS-11HM-400 (Single Slider)

Stroke	1000	1500	2000	2500	3000
A	1549	2049	2549	3049	3549
B	1325	1825	2325	2825	3325
C	1000	1500	2000	2500	3000
D	1085	1585	2085	2585	3085
Weight [kg]	28	34	40	47	53

FS-12HM-400 (Double Slider)

Stroke	1000	1500	2000	2500	3000
A	1649	2149	2649	3149	3649
B	1425	1925	2425	2925	3425
C	1015	1515	2015	2515	3015
D	1185	1685	2185	2685	3185
Weight [kg]	31	37	43	49	56

6.9 FS-11LO-0 (Single Slider), FS-12LO-0 (Double Slider)

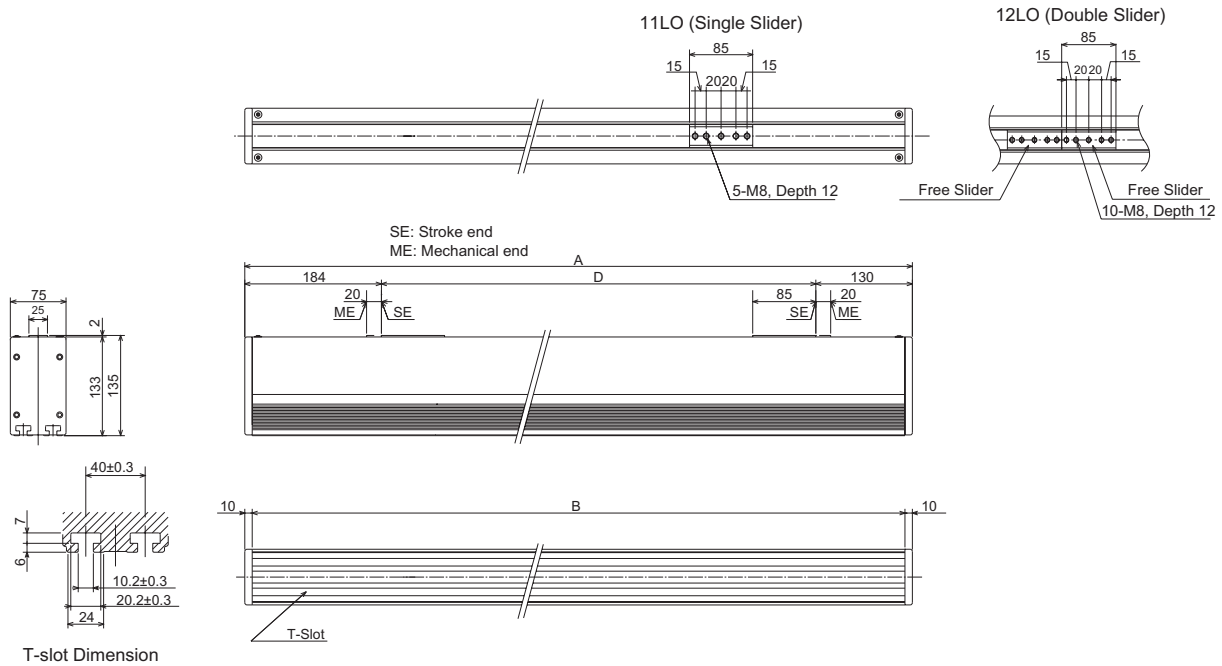

FS-11LO-0 (Single Slider)

Stroke	1000	1500	2000	2500	3000
A	1403	1903	2403	2903	3403
B	1379	1879	2379	2879	3379
C	1000	1500	2000	2500	3000
D	1085	1585	2085	2585	3085
Weight [kg]	19	25	31	38	44

FS-12LO-0 (Double Slider)

Stroke	1000	1500	2000	2500	3000
A	1503	2003	2503	3003	3503
B	1479	1979	2479	2979	3479
C	1015	1515	2015	2525	3025
D	1185	1685	2185	2685	3185
Weight [kg]	22	28	34	40	46

7. Life

The product life is 20,000km (reference) when operating the actuator with the maximum allowable load moment.



8. Warranty

8.1 Warranty Period

One of the following periods, whichever is shorter:

- 18 months after shipment from IAI
- 12 months after delivery to the specified location
- 2,500 hours of operation

8.2 Scope of the Warranty

Our products are covered by warranty when all of the following conditions are met. Faulty products covered by warranty will be replaced or repaired free of charge:

- (1) The breakdown or problem in question pertains to our product as delivered by us or our authorized dealer.
- (2) The breakdown or problem in question occurred during the warranty period.
- (3) The breakdown or problem in question occurred while the product was in use for an appropriate purpose under the conditions and environment of use specified in the operation manual and catalog.
- (4) The breakdown of problem in question was caused by a specification defect or problem, or by a quality issue with our product.

Note that breakdowns due to any of the following reasons are excluded from the scope of warranty:

- 1) Anything other than our product
- 2) Modification or repair performed by a party other than us (unless we have approved such modification or repair)
- 3) Anything that could not be easily predicted with the level of science and technology available at the time of shipment from our company
- 4) A natural disaster, man-made disaster, incident or accident for which we are not liable
- 5) Natural fading of paint or other symptoms of aging
- 6) Wear, depletion or other expected result of use
- 7) Operation noise, vibration or other subjective sensation not affecting function or maintenance

Note that the warranty only covers our product as delivered and that any secondary loss arising from a breakdown of our product is excluded from the scope of warranty.

8.3 Honoring the Warranty

As a rule, the product must be brought to us for repair under warranty.



8.4 Limited Liability

- (1) We shall assume no liability for any special damage, consequential loss or passive loss such as a loss of expected profit arising from or in connection with our product.
- (2) We shall not be liable for any program or control method created by the customer to operate our product or for the result of such program or control method.

8.5 Conditions of Conformance with Applicable Standards/Regulations, Etc., and Applications

- (1) If our product is combined with another product or any system, device, etc., used by the customer, the customer must first check the applicable standards, regulations and/or rules. The customer is also responsible for confirming that such combination with our product conforms to the applicable standards, etc. In such a case we will not be liable for the conformance of our product with the applicable standards, etc.
- (2) Our product is for general industrial use. It is not intended or designed for the applications specified below, which require a high level of safety. Accordingly, as a rule our product cannot be used in these applications. Contact us if you must use our product for any of these applications:
 - 1) Medical equipment pertaining to maintenance or management of human life or health
 - 2) A mechanism or mechanical equipment intended to move or transport people (such as a vehicle, railway facility or aviation facility)
 - 3) Important safety parts of mechanical equipment (such as safety devices)
 - 4) Equipment used to handle cultural assets, art or other irreplaceable items
- (3) Contact us at the earliest opportunity if our product is to be used in any condition or environment that differs from what is specified in the catalog or operation manual.

8.6 Other Items Excluded from Warranty

The price of the product delivered to you does not include expenses associated with programming, the dispatch of engineers, etc. Accordingly, a separate fee will be charged in the following cases even during the warranty period:

- 1) Guidance for installation/adjustment and witnessing of test operation
- 2) Maintenance and inspection
- 3) Technical guidance and education on operating/wiring methods, etc.
- 4) Technical guidance and education on programming and other items related to programs



Change History

Revision Date	Description of Revision
2012.01	Sixth edition Page 6 Note of available and not available added to attachment posture
2012.07	Seventh edition Whole construction revised and corrected
2015.06	Edition 7C Page 29 • Change made in caution note for connection to controller Page 34 • Grease change due to production stop Albania grease No.2 → Albania grease S2 Mobilux 2 → Unirex N2 • Grease supply volume, Recommended grease gun added • Caution note added



IAI Corporation

Head Office: 577-1 Obane Shimizu-KU Shizuoka City Shizuoka 424-0103, Japan
TEL +81-54-364-5105 FAX +81-54-364-2589
website: www.iai-robot.co.jp/

Technical Support available in USA, Europe and China

IAI America, Inc.

Head Office: 2690 W. 237th Street, Torrance, CA 90505
TEL (310) 891-6015 FAX (310) 891-0815
Chicago Office: 110 East State Parkway, Schaumburg, IL 60173
TEL (847) 908-1400 FAX (847) 908-1399
Atlanta Office: 1220 Kennestone Circle, Suite 108, Marietta, GA 30066
TEL (678) 354-9470 FAX (678) 354-9471
website: www.intelligentactuator.com

IAI Industrieroboter GmbH

Ober der Röth 4, D-65824 Schwalbach am Taunus, Germany
TEL 06196-88950 FAX 06196-889524

IAI (Shanghai) Co., Ltd.

SHANGHAI JIAHUA BUSINESS CENTER A8-303, 808, Hongqiao Rd. Shanghai 200030, China
TEL 021-6448-4753 FAX 021-6448-3992
website: www.iai-robot.com

IAI Robot (Thailand) Co., Ltd.

825, PhairojKijja Tower 12th Floor, Bangna-Trad RD., Bangna, Bangkok 10260, Thailand
TEL +66-2-361-4458 FAX +66-2-361-4456